



VHC-32

Variable Heat Controller

for

QUARTZ LAMP (TUNGSTEN) HEATER SOURCES



	⚠ WARNING
	IMPORTANT SAFETY INFORMATION INSIDE <ul style="list-style-type: none">• Serious injury or death possible• Read, understand, and follow all safety information and instructions in this manual before using or servicing this product.

REFER TO COMPLETE
INDEX OF
INFORMATION ON
PAGE 2





INDEX

General Description & Use	Page 3
Specifications	Page 3
Installation & Wiring	Page 4
Mounting Instructions	Page 5
Replacement Parts	Page 6
Limited Warranty	Page 7





ATTENTION:

The table to the right provides definitions of the signal words that can be found throughout this manual. These signal words are used to express the severity of the hazard at hand. The signal words are generally used in conjunction with safety symbols that correspond to the text for that particular hazard. As you read this manual, refer back to this table when you are unsure of the signal word definition.

SIGNAL WORD DEFINITIONS	
	DANGER indicates an imminently hazardous situation which, if not avoided, will result in death or serious injury.
	WARNING indicates a potentially hazardous situation which, if not avoided, could result in death or serious injury.
	CAUTION indicates a potentially hazardous situation which, if not avoided, may result in minor or moderate injury.
	CAUTION used without the safety alert symbol indicates a potentially hazardous situation which, if not avoided, may result in property damage.
<small>As defined in ANSI Z535.4-2002</small>	

GENERAL DESCRIPTION & USE

⚠ WARNING

**ELECTRICAL SHOCK HAZARD
FIRE HAZARD**

- **Serious injury or death may occur.**
- **Not for indoor residential use.**
- **Do not use in locations containing hazardous or explosive atmospheres.**
- **Do not use outdoors in wet conditions and in unprotected locations.**

The Fostoria VHC-32 Variable Heat Controller is a solid-state power control designed to provide a convenient way to adjust heat output on electric infrared heating elements. The faceplate includes an ON/OFF switch that glows red when the controller is in use. It also includes the heat intensity control knob.

Use the VHC-32 to control heaters on patios, in shelter houses or other protected outdoor environments. It is designed for use with 208 or 240 volt 3200 watt Fostoria heaters.

The VHC-32 can be used with any of the following Fostoria heaters:

MODEL	WATTS	HEATER QTY.
MTM-222-208V SERIES	3200	1
MTM-222-240V SERIES	3200	1
RPH-208-A	1600	2
RPH-240-A	1600	2

Note: Faceplate may become warm to the touch during use; this is normal.

SPECIFICATIONS

CAUTION

- 208/240 VAC single-phase single stage controller
- Built-in On/Off switch with surface plate included
- A triac to control heat settings from 10 to 100%.
- Designed for wall mounting in the same space a 4"x 4" electrical wall box would mount.
- Accommodates hardware for 1/2" conduit.
- **Will operate: One (1) or two (2) quartz lamps totaling up to 3200W**

The initial current inrush of T3 quartz lamps is very high; as much as 10 – 15 times the steady-state current. Operating the VHC-32 with more than two (2) 1600W quartz lamps may damage the control.

INSTALLATION & WIRING

⚠ WARNING

ELECTRICAL SHOCK HAZARD



- **Serious injury or death may occur.**
- **Disconnect from electrical supply before installing or servicing this product.**
- **Make certain the power source conforms to specifications on heater label.**
- **Always securely connect green wire from heater to bonding (ground) wire from electrical supply, not to a live or “hot” conductor.**
- **Use 12 AWG, 90° C rated copper wire only. Maximum 50 ft. run.**
- **Follow state, local and national electric codes (NEC).**

For field wiring, refer to the Installation manual included with your heater.

All wiring must be performed by a licensed electrician.

To install the VHC-32:

1. Carefully remove controller cover and mount the enclosure. View mounting options and hole patterns on next page.
2. Feed all power supply and heater wires to enclosure.
3. Attach the (3) wires from the controller to the triac located in the upper left hand corner of enclosure. **NOTE:** The wires must be terminated on the triac as shown per wiring diagram below or label located in the enclosure. Failure to do so will result in premature failure of the controller.
4. Wire to power source and heater as shown in wiring diagram using (4) wire nuts provided. Note that wires marked “L1” or “L2” can be attached to either incoming power lead. Also, the wire marked “H1” and “H2” can be wired to either lead going out to the heater.
5. Attach bonding (ground) wires to green ground lead in back of box.
6. Using the (4) screws provided, attach the cover to the enclosure. **Be careful not to damage the controller or internal wiring when positioning the cover.**

CAUTION

The triac must be wired as shown in the wiring diagram. Failure to do so will result in premature failure of the controller.

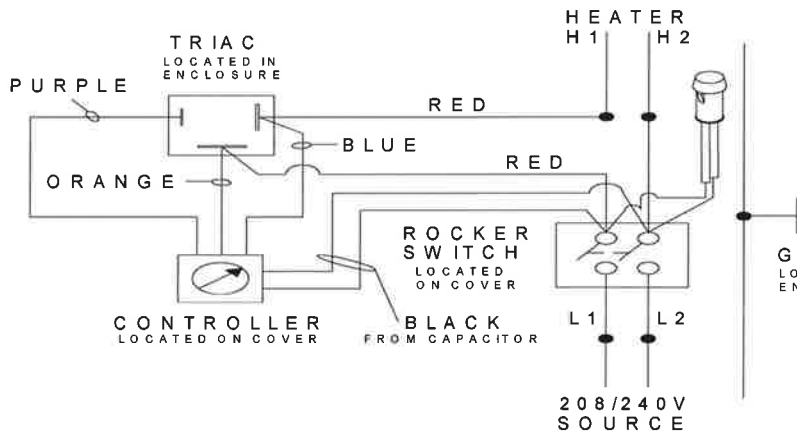

MOUNTING INSTRUCTIONS

One hole on top and one on bottom for 1/2" conduit fittings

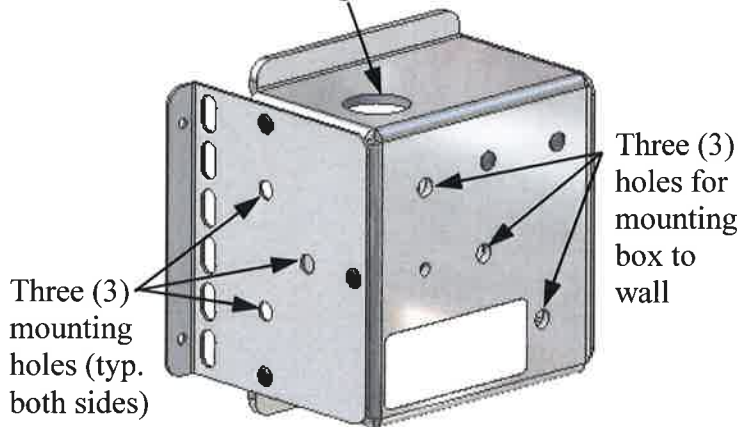

Back view of controller box



⚠ WARNING

ELECTRICAL SHOCK HAZARD FIRE HAZARD

- Serious injury or death may occur.
- Plug all unused conduit openings with suitable plug after installation.
- Enclosure supplied with unit must be used.
- Modifying the enclosure will void the manufacturer's warranty
- Do not block or cover the vent holes shown in Figures 2 and 3.
- Do not fully recess unit.

FIGURE 2
Surface Mounted

FIGURE 3
Semi-Recessed Mounted

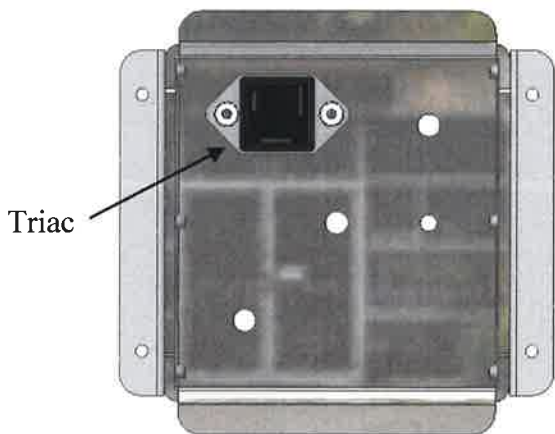
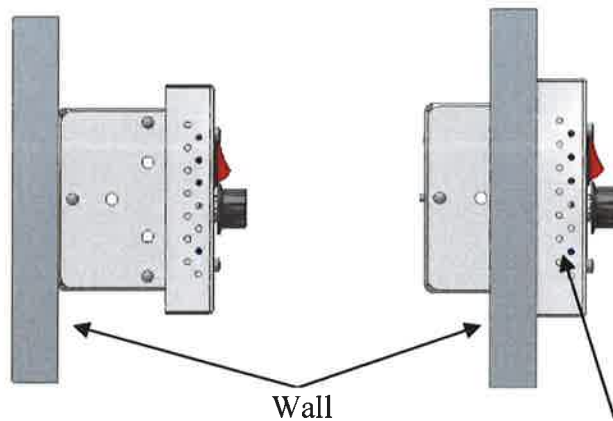

FIGURE 1



Vent holes; typical on all 4 sides

-When installing the VHC enclosure, the triac **must** be positioned in the upper left hand corner, refer to Figure 1.

Semi-Recessed Applications

- Minimum wall depth required: 2-3/4"
- Rough opening size:
 - min.: 4-1/8" x 4-1/8"
 - max.: 4-1/4" x 4-1/4"

REPLACEMENT PARTS

If you need to replace one of the parts on your VHC-32 shown below, you can purchase it through your local distributor or directly from Fostoria Industries Customer Service.



Rocker Switch
Part No.: 3111700



Knob
Part No.: 3183800

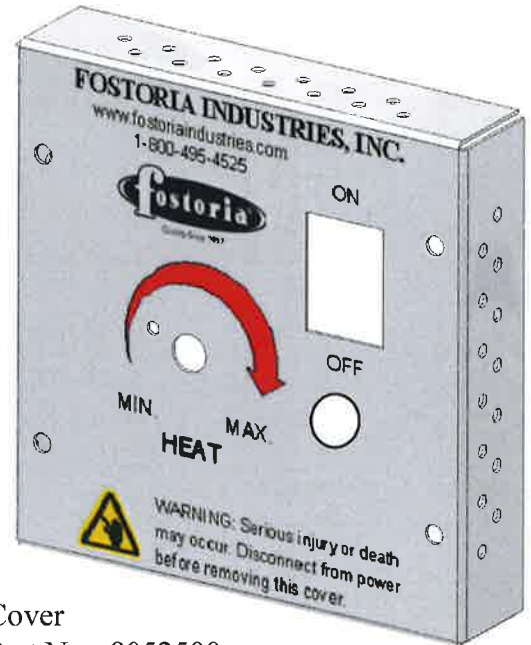

Cover
Part No.: 8052500



Pilot Light
Part No.: 52123-003



Triac
Part No.: 8892800

LIMITED WARRANTY

Products manufactured by TPI Corporation are warranted to the original consumer to be free from defects in material and workmanship for twelve (12) months from the original purchase date.

The TPI limited warranty does not cover products that have been modified outside of our factory, damage or failure caused by acts of God, abuse, misuse, connected to or placed on other than rated voltage, abnormal usage, fault, installation, failure to follow suggested maintenance procedures enclosed with the product, improper maintenance or any repairs other than those provided by an authorized TPI service center.

There are no obligations or liabilities on the part of the Corporation for consequential damages arising out of or in connection with the use or performance of the product or other indirect damages with respect to loss of property, revenues, profit, costs of removal installation, or reinstallation.

All implied warranties with respect to TPI products, including implied warranties for merchantability and implied warranties for fitness, are limited in duration to twelve (12) months from original date of purchase, except those products or parts of products which are warranted for long periods thereon.

Some states do not allow the exclusions or limitation of incidental or consequential damages and some states do not allow limitations on how long an implied warranty lasts. The above exclusions or limitations may not apply to you.

During the warranty period, TPI Corporation will, at its sole option, repair or replace any defective parts or products returned, freight prepaid, to the TPI Corporation factory or such other locations as TPI Corporation may designate. Returned products must be packaged carefully and TPI Corporation shall not be responsible for damage in transit.

When returning parts, the owner must provide the model number of the product and nature of difficulty being experienced. This warranty does not obligate TPI Corporation to bear the cost of labor in replacing any assembly, unit or component part thereof, nor does the company assume any liability for secondary charges, expenses for installing or removal, freight or damages. There will be charges rendered for product repairs made after the warranty period has expired. Proof of purchase, including date, must accompany request for in-warranty service. In any event, TPI Corporation's maximum liability shall not in any case exceed the list price for the product claimed to be defective. This warranty gives to you specific legal rights and you may have other rights, which may vary from state to state. For the name of your nearest authorized TPI Corporation service center, please write to TPI Corporation, P.O. Box 4973, Johnson City, TN 37602.

HEATING PRODUCTS WARRANTY COVERAGE	
Heating Products Elements in	10 Years
Baseboards	1 Year
All other Heating Products	2 Years
Thermostats and Controls	

VENTILATION PRODUCTS WARRANTY COVERAGE	
Series HD or HDH Fans	5 Years
Series UHP or IHP Fans	3 Years
All other Ventilation Products	1 Year