

Reference Manual

# Solaira

# Alpha H2

(Double Emitter)

**CANADA & USA MODELS:**  
SALPHAH2-20240 (208 / 240V - 1500 / 2000W)  
SALPHAH2-30240 (208 / 240V - 2250 / 3000W)  
SALPHAH2-40240 (208 / 240V - 3000 / 4000W)



**WEATHERPROOF INFRARED HEATERS  
SUITABLE FOR OUTDOOR AND INDOOR USE -  
RESIDENTIAL, COMMERCIAL AND INDUSTRIAL**



**INFOSIGHT CONSUMER PRODUCTS INC.**

125 Traders Blvd. E Unit # 4, Mississauga, Ontario L4Z 2H3

Tel: 905-568-7655 - Fax: 905-568-7521

Email: [info@solairaheaters.com](mailto:info@solairaheaters.com) - Website: [www.solairaheaters.com](http://www.solairaheaters.com)

**▲ IMPORTANT - SAVE THESE INSTRUCTIONS FOR FUTURE REFERENCE**



## IMPORTANT INSTRUCTIONS



When using electrical INFRARED HEATERS, basic precautions should always be followed to reduce the risk of fire, electric shock, and injury to persons, including the following:

1. **Read all instructions before using this heater.**
2. Use this heater only as described in this manual. Any other use not recommended by the manufacturer may cause fire, electric shock, or injury to persons.
3. This heater is hot when in use. To avoid burns, do not let bare skin touch hot surfaces. If provided, use handles when moving this heater. Keep combustible materials, such as furniture, pillows, bedding, papers, clothes, and curtains at least 6 feet (1.8m) from the front of the heater and keep them away from the sides and rear.
4. Extreme caution is necessary when any heater is used by or near children or invalids and whenever the heater is left operating and unattended.
5. Do not operate any heater with a damaged cord or after the heater malfunctions, has been dropped or damaged in any manner. Return heater to authorized service facility for examination, electrical or mechanical adjustment, or repair.
6. This heater is not intended for use in bathrooms, laundry areas and similar locations. Never locate heater where it may fall into a bathtub or other water container.
7. To disconnect heater, turn controls to off.  
**WARNING** - Each power supply circuit shall be provided with disconnecting means and the disconnecting means shall be grouped together.



## IMPORTANT INSTRUCTIONS



8. Do not insert or allow foreign objects to enter any opening as this may cause an electric shock or fire, or damage the heater.
9. To prevent a possible fire, do not block openings in any manner.
10. A heater has hot parts inside. Do not use it in areas where gasoline, paint, or flammable liquids are used or stored.
11. Do not cover or otherwise obstruct the heater.



## SAVE THESE INSTRUCTIONS



### GROUNDING INSTRUCTIONS

For 240 (or 208) volt heaters. The cords from each terminal box must be hard wired.



## WARNING: RISK OF FIRE



Keep combustible material such as furniture, papers, clothes and curtains at least 6 feet (1.8m) from the front of the heater and away from the sides and rear.

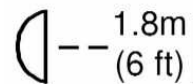

# INTRODUCTION

The Alpha H2 heater produces radiant heat like the sun, warming people and objects rather than the air in between. It is mounted on an adjustable bracket that allows the heat to be directed exactly where it is required. The Alpha H2 can also be used in a modular system in that more than one heater can be connected together - see 'Configurations' later in the manual. The Alpha H2 weatherproof heater is designed for indoor and outdoor use.

**Please read the following instructions carefully before use. The safety of this heater is guaranteed only by its correct usage in accordance with these instructions, therefore they should be retained for future reference.**

## **CAUTION**

Before using this appliance:

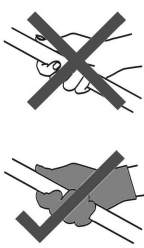
1. Check that the voltage indicated on the units rating label corresponds to the mains supply voltage.
2. Do not install the heaters less than the minimum height from the floor as specified below in the specification - Table. 1.
3. Ensure that the heater has been securely fastened in its final mounting position.
4. **WARNING** - This appliance must be grounded and hard wired! 
5. **WARNING** - Keep the mains cable away from the body of the heater which will get hot during use.
6. Do not cover or obstruct the heater while it is in use.
7. Do not insert any object through any slot or opening in the heater.
8. Do not use if guard is not present.
9. When replacing the emitter or cleaning the unit, ensure that the hard wired circuit(s) is disconnected from the mains supply. **Note:** always ensure that the emitter is cool before handling.
10. Do not handle the halogen emitter with bare hands. If it is inadvertently touched, remove finger marks with a soft cloth and methylated spirit or rubbing alcohol. Otherwise, the marks will burn into the quartz emitter during use causing premature heater failure. 
11. The heater is not intended for use by young children and must be supervised by a responsible person at all times.

# SPECIFICATION

Table 1. Canada and USA Heaters

| No. of Units ×<br>Model Type                                   | 1 ×<br>SALPHAH2-<br>20240                         | 1 ×<br>SALPHAH2-<br>30240 | 1 ×<br>SALPHAH3-<br>40240 | 2 ×<br>SALPHAH2-<br>20240                          | 2 ×<br>SALPHAH2-<br>30240               | 2 ×<br>SALPHAH2-<br>40240               | 3 ×<br>SALPHAH2-<br>20240                          | 3 ×<br>SALPHAH2-<br>30240               | 3 ×<br>SALPHAH2-<br>40240               |
|--|---|---------------------------|---------------------------|--|---|---|--|---|---|
| Voltage (Volts)  | 208 / 240   |                           |                           |  |   |   |  |   |   |
| No. of Emitters ×<br>Power (Watts)                             | 2 ×<br>750 / 1000                                 | 2 ×<br>1125 / 1500        | 2 ×<br>1500 / 2000        | 4 ×<br>750 / 1000                                  | 4 ×<br>1125 / 1500                      | 4 ×<br>1500 / 2000                      | 6 ×<br>750 / 1000                                  | 6 ×<br>1125 / 1500                      | 6 ×<br>1500 / 2000                      |
| Total Power of<br>Unit (Watts)                                 | 1500 / 2000                                       | 2250 / 3000               | 3000 / 4000               | 3000 / 4000  | 4500 / 6000                             | 6000 / 8000                             | 4500 / 6000  | 6750 / 9000                             | 9000 / 12000                            |
| Current (Amps)<br>per Emitter                                  | 3.6 / 4.2   | 5.4 / 6.3                 | 7.2 / 8.3                 | 3.6 / 4.2  | 5.4 / 6.3                               | 7.2 / 8.3                               | 3.6 / 4.2  | 5.4 / 6.3                               | 7.2 / 8.3                               |
| Total Current<br>(Amps) of Unit                                | 7.2 / 8.3   | 10.8 / 12.5               | 14.4 / 16.7               | 14.4 / 16.7  | 21.6 / 25.0                             | 28.8 / 33.3                             | 21.6 / 25.0  | 32.5 / 37.5                             | 43.3 / 50.0                             |
| Min. Mounting<br>Height From<br>Floor                          | 79 in / 98¼ in<br>(201 cm /<br>250 cm)            | 98¼ in<br>(250 cm)        |                           |  | 108 in / 120 in<br>(274 cm /<br>305 cm) | 120 in / 144 in<br>(305 cm /<br>366 cm) | 108 in / 120 in<br>(274 cm /<br>305 cm)            | 132 in / 158 in<br>(335 cm /<br>401 cm) | 158 in / 177 in<br>(401 cm /<br>450 cm) |
| Min. Distance<br>From Ceiling ▲                                | 19½ in<br>(50 cm)                                 |                           |                           |  |   |   |  |   |   |
| Min. Distance<br>From Side Wall                                | 39½ in<br>(100 cm)                                |                           |                           |  | 59 in<br>(150 cm)                       |   |  |   |   |
| Dimensions -<br>W × H × D (inc.<br>bracket & bars<br>max pos.) | 32¼ in × 9 in × 12¾ in<br>(82 cm × 23 cm × 32 cm) |                           |                           | 32¼ in × 18¼ in × 5¾ in<br>(82 cm × 47 cm × 15 cm) |   |   | 32¼ in × 27¼ in × 5¾ in<br>(82 cm × 69 cm × 15 cm) |   |   |
| Weight   | 12.3 lb<br>(5.6 kg)                               |                           |                           | 24.7 lb<br>(11.2 kg)                               |   |   | 37.0 lb<br>(16.8 kg)                               |   |   |

▲ **WARNING - RISK OF FIRE:** Heaters rated at 208 / 240 Volt, 2 Kilowatt and above are not intended for use as indoor residential or as a household heater but maybe used for commercial/industrial use.

# CONFIGURATIONS

The Alpha H2 heater is a double emitter - it contains two emitters. It can be installed as a single unit or joined to one or two more single units. Joining bars are available that connect the heaters together to increase the size and output of the installation. The maximum number of units that can be joined together is three. Please read the section 'joining heaters together' for information on how this should be done.

## INSTALLATION

The 208 / 240V version of the heater is fitted with 2 × supply cords measuring 79 inches (200 cm) for hard wiring.

- ⚠ WARNING:** Wiring procedures and connections should be in accordance with the National Electric Code (NEC) and local codes.
- ⚠ WARNING:** If the supply cord(s) becomes damaged, it must be immediately replaced by a qualified person in order to avoid a hazard.
- ⚠ CAUTION:** Disconnect electric power supply before working on circuit wiring to prevent electric shock.
- ⚠ CAUTION:** Please observe the minimum safe distance between the heater body and any inflammable surfaces.
- ⚠ CAUTION:** When the electrical connection is outside weatherproof sockets must be used having ground fault protection (GFCI or GFI).

**! NOTE: CONSULT A QUALIFIED ELECTRICIAN, IF IN DOUBT.**

## MOUNTING - 1 × DOUBLE (TWO EMITTERS) UNIT

**⚠ CAUTION ⚠**

**Switch off/unplug the heater from the mains supply when mounting or adjusting the heater position.**

- The Alpha H2 heater should only be wall mounted in a horizontal manner or hung from a ceiling from chains (not supplied).
- When wall mounting the Alpha H2 heater in a horizontal manner, do not position the heater at an angle more than 50° and less than 30° as shown in Fig. A.
- When ceiling hanging the Alpha H2 heater, ensure the minimum distance from the ceiling is adhered to as shown in Fig. B.

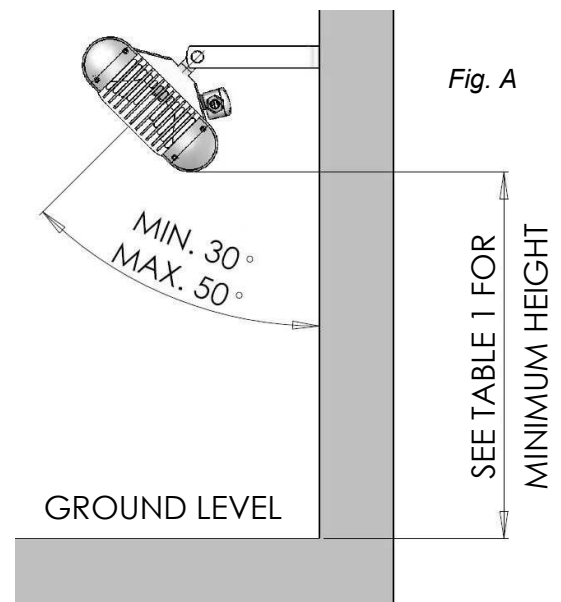

*Continued on next page...*

- Always allow the heater to cool before attempting to reposition/move. Never attempt to move the heater while it is switched on!
- Observe the minimum safe distance between the heater body and inflammable surfaces and objects when mounting.
- Please refer to Table 1 for the recommended positioning of the heater with regards to minimum distances. Do not install the heater in a corner!
- Keep out of the reach of children.

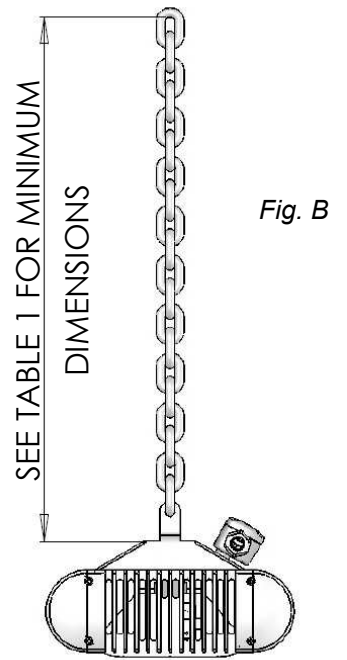

Fig. B

1. When wall mounting, securely fasten the L-shaped wall brackets to the mounting surface using both of the fixing holes in the short part of the bracket (see Fig. D for mounting hole centres). Please refer to Table 1 for recommended positioning of the heater. Please note, wall fixings are not supplied. They should be selected to substantially support the weight of the installation. If in doubt contact a professional for advice! When hanging from a ceiling two equal length and gauge chains are required and should be selected with fixings that are adequate to hold the weight of the heater. Again, if in doubt contact a professional for advice!
2. The heater should be mounted with the terminal box at the bottom of the heater when being wall mounted.
3. When wall mounting, fix in the required angular position by tightening the fixing bolts on the brackets at the rear of the heater as shown in Fig. C. The heater should face directly down when hanging.
4. Secure the supply cable so it is not resting on the body or obstructing the air-vents.

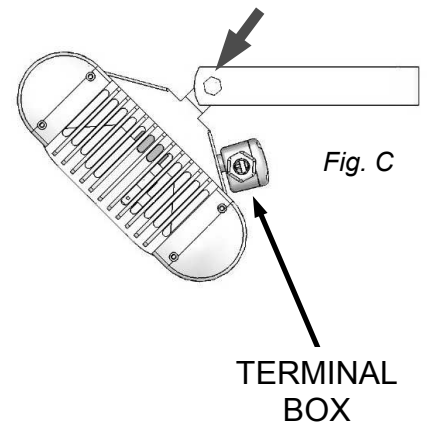

Fig. C

**Always isolate the heater from the mains supply when adjusting the position.**

**DRILLING HOLE TEMPLATE DIMENSIONS FOR WALL MOUNTED BRACKETS**

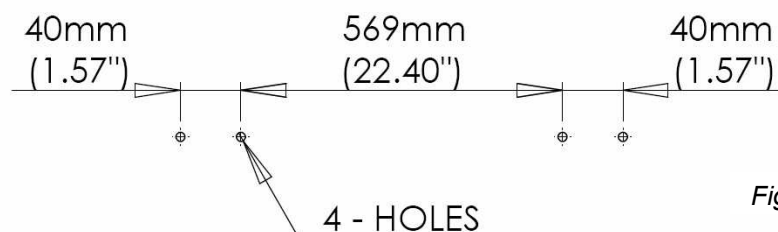

Fig. D

## ASSEMBLING - 2 × DOUBLE (TWO EMITTERS) HEATERS JOINED

1. Take the first heater and place it face down on a flat surface.
2. Take the second heater and place it face down and positioned parallel to the first heater.
3. Push the bolts used to hold the wall brackets through the hole in the brackets on the rear heaters and slide a shake-proof washer on all the threads from the protruding side.
4. Slide the joining bars on each bolt and fit a washer and nut – do not fully tighten at this point.
5. Ensure the second heater is still parallel to the first and sitting flat.
6. Slide the joining bars on each protruding bolt of the other heater to connect them together and fit the washers and nuts.
7. Again, ensuring the heaters remain flat, fully tighten all four nuts to secure the joining bars in place.

## CHAIN HANGING - 2 × DOUBLE (TWO EMITTERS) HEATERS JOINED



**Switch off/unplug the heater from the mains supply when mounting or adjusting the heater position.**

- When two Alpha H2 heaters are joined they should only be hung from a ceiling on chains - do not wall mount!
- Always allow the heater to cool before attempting to reposition/move. Never attempt to move the heater while it is switched on!
- Observe the minimum safe distance between the heater body and inflammable surfaces and objects when mounting.
- Please refer to Table 1 for the recommended positioning of the heater with regards to minimum distances. Do not install the heater in a corner!
- Keep out of the reach of children.

1. Please refer to Table 1 for recommended positioning of the heater. When hanging from a ceiling two chains of equal length and gauge are required and should be selected with fixings that are adequate to hold the weight of the heater. If in doubt contact a professional for advice!

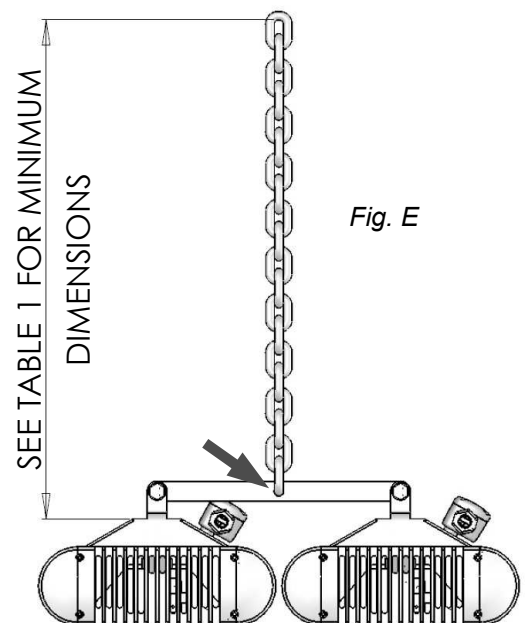

*Continued on next page...*



2. Fix the heater assembly to the chains via the hole in the centre of the joining bar as shown in Fig. E and ensure the heaters face directly down when hanging.
3. Secure the supply cable so it is not resting on the body or obstructing the air-vents.

**Always isolate the heater from the mains supply when adjusting the position.**

## **ASSEMBLING - 3 × DOUBLE (TWO EMITTERS) HEATERS JOINED**

1. Take the first heater and lie it face down on a flat surface.
2. Take the second and third heaters and position them face down and parallel to the first.
3. Push the bolts used to hold the wall brackets through the hole in the brackets on the rear heaters and slide a shake-proof washer on all the threads from the protruding side.
4. Slide the joining bars on each bolt and fit a washer and nut – do not fully tighten at this point.
5. Position the second heater so it's parallel to the first and sitting flat.
6. Take the third heater and a joining bar. Push a bolt and washer through the end hole and place a serrated washer on the other side. Push the bolt through the bracket hole on heater. Repeat on opposite side and secure with a washer and nut – do not fully tighten at this point.
7. Position the third heater so it's parallel to the second.
8. Line-up the bars of the first heater with the brackets of the second heater – they should go on the inside faces like heater one.
9. Line-up the bars of the third heater with the brackets of the second heater – these should go on the outside faces like heater three.
10. Push a bolt from the back of the joining bars through the holes putting a serrated washer on each side of the heater bracket.
11. Fit a washer and nut to both sides and providing the assembly is sitting flat, fully tighten both sides and also the nuts of the first and third heaters to the joining bars.
12. The heater is now ready for hanging.

# CHAIN HANGING - 3 × DOUBLE (TWO EMITTERS) HEATERS JOINED

## **CAUTION**

Switch off/unplug the heater from the mains supply when mounting or adjusting the heater position.

- When three Alpha H2 heaters are joined they should only be hung from a ceiling on chains - do not wall mount!
  - Always allow the heater to cool before attempting to reposition/move. Never attempt to move the heater while it is switched on!
  - Observe the minimum safe distance between the heater body and inflammable surfaces and objects when mounting.
  - Please refer to Table 1 for the recommended positioning of the heater with regards to minimum distances. Do not install the heater in a corner!
  - Keep out of the reach of children.
1. Please refer to Table 1 for recommended positioning of the heater. When hanging from a ceiling four chains of equal length and gauge are required and should be selected with fixings that are adequate to hold the weight of the heater. If in doubt contact a professional for advice!
  2. Fix the heater assembly to the chains via the hole in the centre of the joining bars as shown in Fig. F. and ensure the heaters face directly down when hanging.
  3. Secure the supply cable so it is not resting on the body or obstructing the air-vents.

**Always isolate the heater from the mains supply when adjusting the position.**

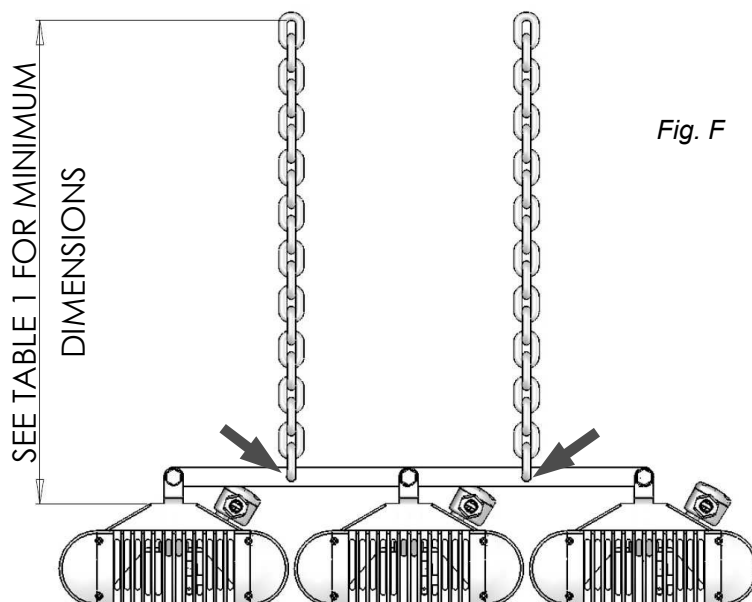

## MAINTENANCE

**!** **NOTE:** For replacement emitters or spare parts please contact your local distributor quoting model type and rating from rating label. It is very important that your replacement emitter is exactly the same as the one it was supplied with. Failure to fit the exact same type can cause the heater to prematurely fail.

**⚠ CAUTION:** Unplug/Switch off unit from the mains supply before replacing emitter or any maintenance procedure including cleaning.

**⚠ CAUTION:** Should dust or dirt appear on the reflector, it is recommended that the guard and emitter are removed and the reflector is wiped with a lint-free cloth before reassembling (see emitter replacement instructions).

## REPLACING AN EMITTER



### CAUTION



Unplug/switch off from the mains to the heater or heater assembly power before any attempts are made to replace the emitter. Contact your distributor for the correct replacement emitter quoting model type and rating from rating label. It is important that you read through the emitter replacement procedure before commencing.

1. Ensure the heater and emitter are cool and the power supply is disconnected or remove the plugs from the socket outlet - all plugs must be removed even if only one emitter is to be replaced.

2. Remove the screws from the terminal box at the back of the emitter to be replaced and lift off the lid - see Fig. G.



Fig. G

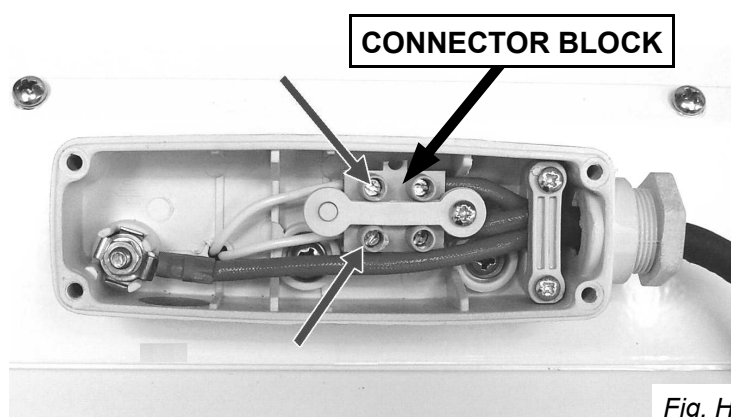
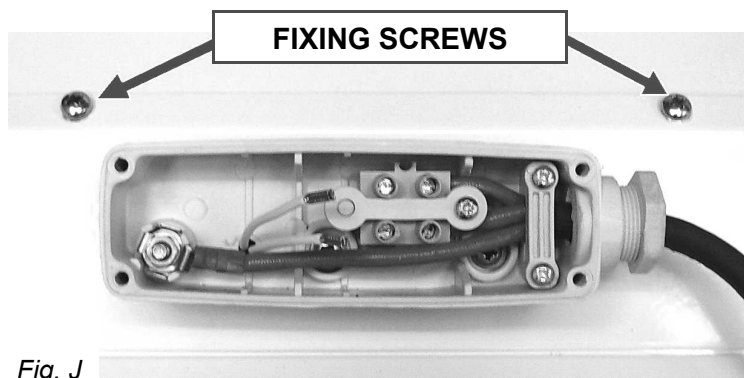

Fig. H

3. Disconnect the emitter from the connector block by unscrewing the screws highlighted above in Fig. H and remove the white coloured emitter wires from the connector block.

*Continued on next page...*

4. At the back of the heater, remove the plate holding the terminal box by removing the two fixing screws as shown in Fig. J.



5. Pull the emitter wires one at a time through the plate to remove as shown in Fig. K.

6. At the front of the heater, gently remove the wire guards by prizing them away from their locating holes at one end of the heater case (Fig. L) and pull out of opposite end.

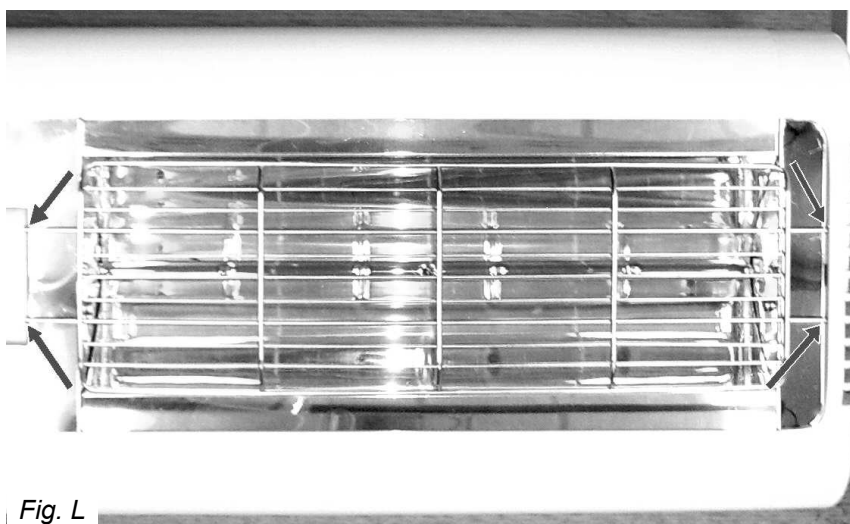

7. Remove the screws from the central reflector/cover on both sides (Fig. M) and the single screw from the side reflector (Fig. N). Lift them up and away from the heater to reveal the ceramic caps on the emitters.

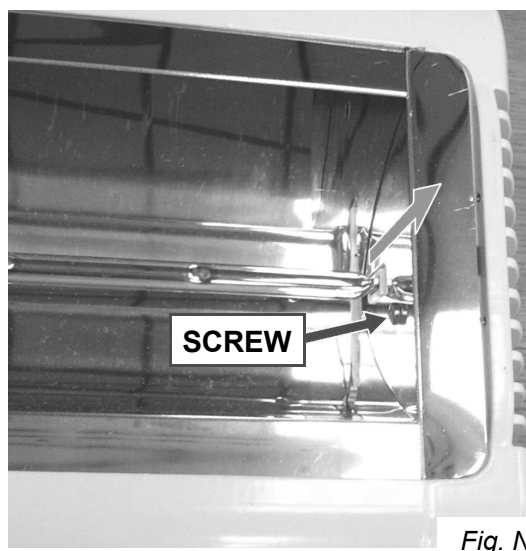
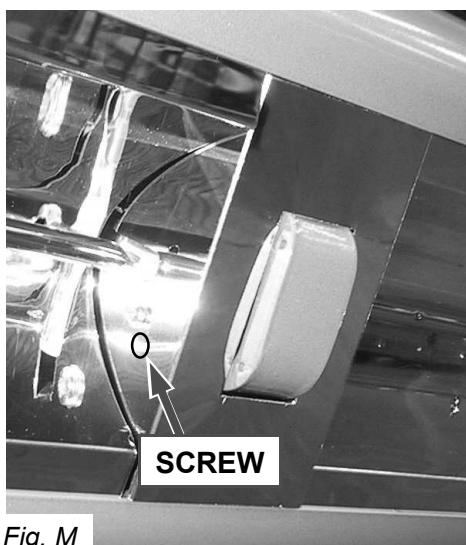

Continued on next page...

**8.** Release the emitter end by pressing the top edge of the spring clip away from the emitters ceramic end-cap. Gently lift the end of the emitter upwards so it is no longer being retained by the clip (see Fig. O). The wire can then be gently pulled from behind the reflector.

**9.** The emitter wire at the opposite end should be pulled out of the side slot (see Fig. P) and the emitter can be lifted up completely. The wire can then be gently pulled forward so that it also comes out from behind the reflector.

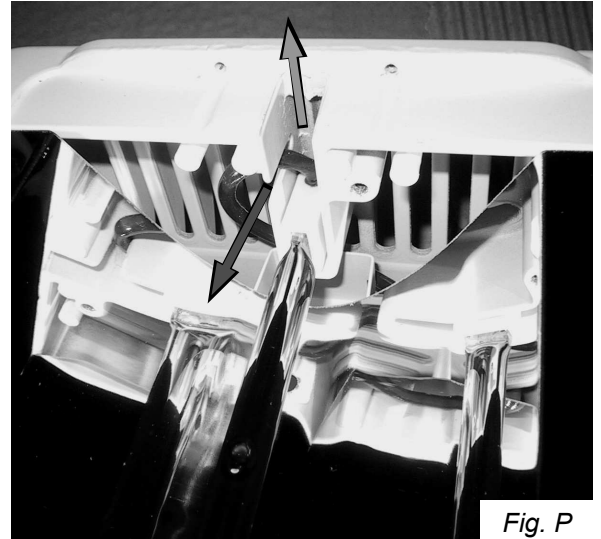
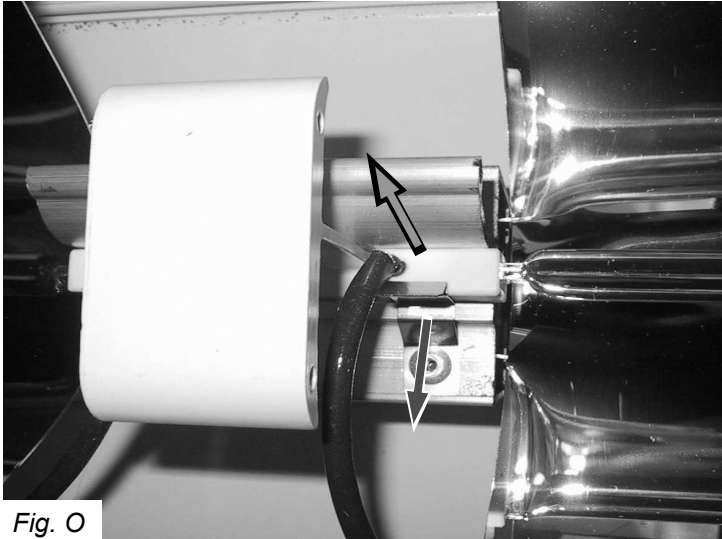

**10.** The emitter can now be removed away from the heater leaving it ready for the new emitter to be fitted as shown in Fig. Q.



**11.** Refit the new emitter in reverse order making sure that no wires can get trapped. Replace the side reflectors/covers and their screws before any other parts are fitted to make sure the emitter is held safely.

## WALL MOUNTED CONFIGURATION - AT A GLANCE

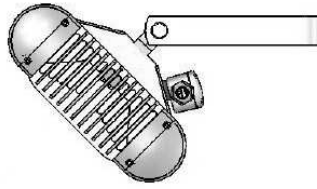

1 x Alpha H2 Unit

# CHAIN HANGING CONFIGURATIONS - AT A GLANCE

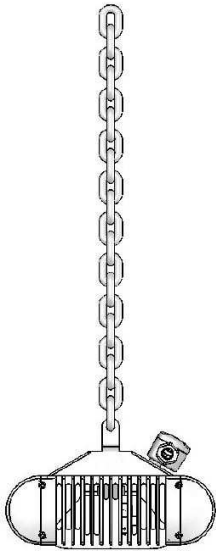

1 x Alpha H2 Unit

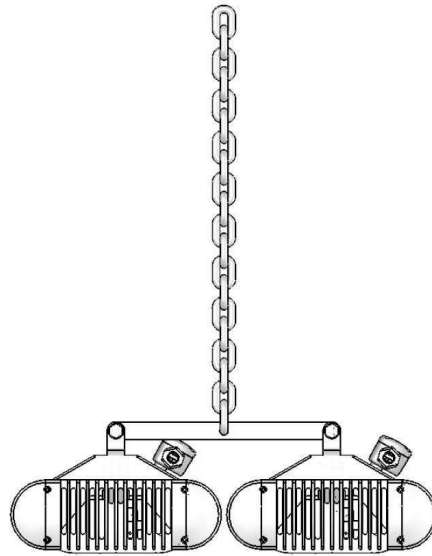

2 x Alpha H2 Units

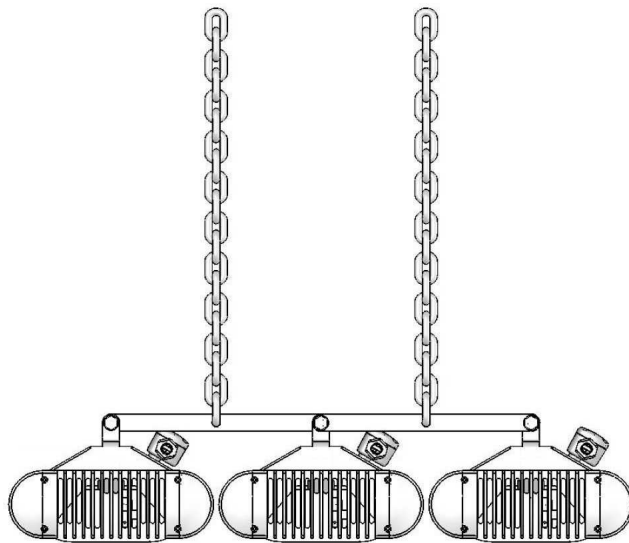

3 x Alpha H2 Units



**IMPORTANT - SAVE THESE  
INSTRUCTIONS FOR FUTURE REFERENCE**

---

**INFORESIGHT CONSUMER PRODUCTS INC.**

125 Traders Blvd. E Unit # 4, Mississauga, Ontario L4Z 2H3  
Tel: 905-568-7655 - Fax: 905-568-7521  
Email: [info@solairaheaters.com](mailto:info@solairaheaters.com) - Website: [www.solairaheaters.com](http://www.solairaheaters.com)



Due to our policy of ongoing improvement, we reserve the right to make changes without notice.

© 2013 INFORESIGHT CONSUMER PRODUCTS INC.

Ref No. 042225 Issue No. 3