

Solaira SMaRT 34-DV Variable Controller Installation & User Manual

KEEP THESE INSTRUCTIONS FOR FUTURE REFERENCE



SAFETY WARNING



ALL INSTALLATIONS/SERVICE MUST ONLY BE PERFORMED BY A LICENSED/CERTIFIED ELECTRICIAN TO LOCAL AND NATIONAL ELECTRICAL CODE (NEC).



**WARNING: SHOCK AND FIRE
HAZARD:**



- Serious injury or death could occur
- Disconnect ALL power sources before removing cover. Power should only be re-connected after electrical installations are complete and cover replaced
- Be certain the power source conforms to the specifications outlined on the heater label
- Maximum heater load **SHOULD NOT EXCEED 38 AMPERE**
- The unit must be externally fused
- The Controller **MUST BE PROPERLY GROUNDED**. Ensure that the ground connection from the electrical supply is connected to the Controller and Heater ground using a green sleeved conductor.
- Do not connect the Controller or Heater ground connection to a live or “hot” conductor.
- Follow state, provincial, local and national electric codes (NEC) including field certifications
- Do not use in locations containing hazardous or explosive atmospheres.

ELECTRICAL RATING

Maximum load

8.0kW @208-240VAC 50/60HZ

4.0kW @120VAC 50/60HZ



**WARNING SERIOUS INJURY OR DEATH COULD OCCUR,
DISCONNECT ALL POWER PRIOR TO SERVICE**



INTRODUCTION

The Solaira SMaRT 34-DV Variable Control has been engineered to work with Infrared Heaters, with a maximum rating of 8.0kW @ 208-240V or 4.0kW @ 120V.

The Solaira SMaRT 34-DV Control has a 1 to 5 step setting allowing you to find the optimum comfort setting in your specific area.

To increase output to full output, press and release red  button.

To increase in increments, press and hold the red  button until the desired number is reached.

To reduce output to OFF, press and release red  button.

To reduce in increments, press and hold the red  button until the desired number is reached

FEATURES

- Weatherproof control for exposed, wet conditions (it is the electricians responsibility to assure correct water tight connection, this may necessitate replacing included watertight strain relief)
- Variable Control – Ability to adjust output to desired comfort level
- Soft Start – zero current switching point which can extend emitter lamp life
- Temperature Monitoring – Solaira SMaRT 34-DV Variable control is equipped with a local (on controller) temperature monitor. This will allow user to pre-set the minimum temperature level that will allow the controller to operate.

Note: the temperature monitor is calibrated in Celsius; please use the following table to aid in set up:

Fahrenheit	Celsius	Fahrenheit	Celsius
32.0	0.0	55.0	12.8
36.0	2.2	60.0	15.6
40.0	4.4	65.0	18.3
45.0	7.2	70.0	21.1
50.0	10.0	75.0	23.9
		80.0	26.7

- Infrared remote control interface which supports the Solaira SMaRT infrared remote control handset (sold separately) which must be in line of sight of the controller.
- Occupancy Sensor or Push button input (sold separately), which is used to re-trigger an internal "ON" timer. The "ON" timer is configurable from 1-60 minutes by means of a trimmer potentiometer. If the internal "ON" timer expires the load output is switched off.
- Designed for optional remote, wired controller for use in dry, wall mount electrical box (sold separately).



WARNING: Solaira SMaRT 34-DV Variable control is a high power electrical device and MUST ONLY BE INSTALLED BY A CERTIFIED ELECTRICIAN TO LOCAL AND NATIONAL ELECTRICAL CODE

INSTALLATION

The control can be installed in a convenient VENTED location and does not have to be installed in the immediate area of the heaters. The unit is shipped with the Occupancy sensor/pushbutton input fitted with a wire link which continually re-triggers the "ON" timer so that it never expires.

If the user decides to utilize the optional Occupancy Monitor, the occupancy monitor should be mounted 8' (2.5 + Meters) above of the floor. Ceiling mounting is preferred but not essential. The Optional Occupancy monitor must not be mounted directly in line with the heaters output, highly reflective surfaces, radiators or other thermostatically controlled heaters or open door ways with people walking past.



WARNING: CONTROLLER MOUNTING

It is important that the controller is **not** mounted directly on any flammable material i.e. wood AND in ventilated area free of flammable vapours or materials. It is recommended that the heat sink be spaced off the mounting wall using pillars to aid in heat dissipation.

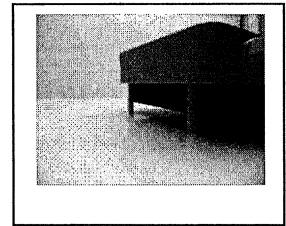

INITIAL START UP WITH OPTIONAL OCCUPANCY SENSOR

- Optional Occupancy Sensor (sold separately), it takes 60 seconds to set before detection takes place
- Optional Occupancy Sensor continues to monitor the area and will reset to the set time every time it detects movement.
- Before testing ensure the wiring is correct.
- Temperature trip point has already been pre-set at the factory.
- Timer is pre-set to 1 minute but can be adjusted using timer trimmer potentiometer to 1-60 minutes.
- The expected detection area can now be "walked tested" using the diagram shown in mind. The area should be crossed in various directions to ensure coverage is as expected.

DISPLAY FEATURES

Display shows "t"	The unit is turned OFF as the ambient temperature is above the trip level set by TEMPERATURE SETPOINT.
Display shows "0"	The output is OFF
Display shows "1", "2", "3", "4"	The unit is ON at the indicated power level
Display shows 'F'	The unit is set to FULL output.
Display flashing "."	The "ON" timer has expired and is waiting to be re-triggered by the Occupancy sensor (i.e. no movement detected for "ON" time) or the pushbutton.
Display shows "."	The unit is in Standby mode pressing the optional fully on remote control POWER button will toggle the power ON and OFF.

You can check the remote control is transmitting by observing the "." (dot) flashing rapidly.

SMaRT 34-DV ILLUSTRATIVE WIRING DIAGRAM*



**WARNING SERIOUS INJURY OR DEATH COULD OCCUR,
DISCONNECT ALL POWER PRIOR TO SERVICE**

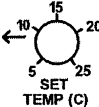
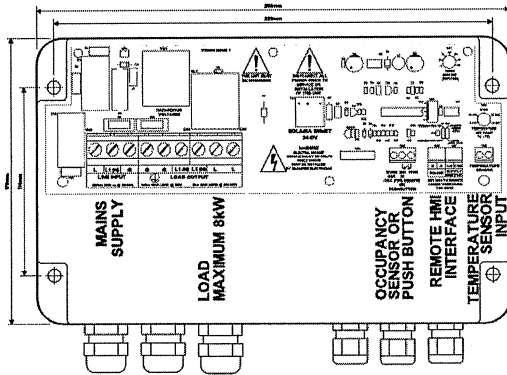

FAHRENHEIT	CELSIUS
32.0	0.0
36.0	2.2
40.0	4.4
45.0	7.2
50.0	10.0
55.0	12.8
60.0	15.6
70.0	21.1
75.0	23.9
80.0	26.7

**WARNING: RISK OF INJURY OR DEATH
ENSURE ALL POWER IS OFF FOR
INSTALLATION OR SERVICE**

*** ALL SOLAIRA HEATERS AND
CONTROLLERS SHOULD BE
INSTALLED BY CERTIFIED
ELECTRICIANS TO LOCAL
STATE/PROVINCE NEC CODE**

LINE & LOAD CONNECTION

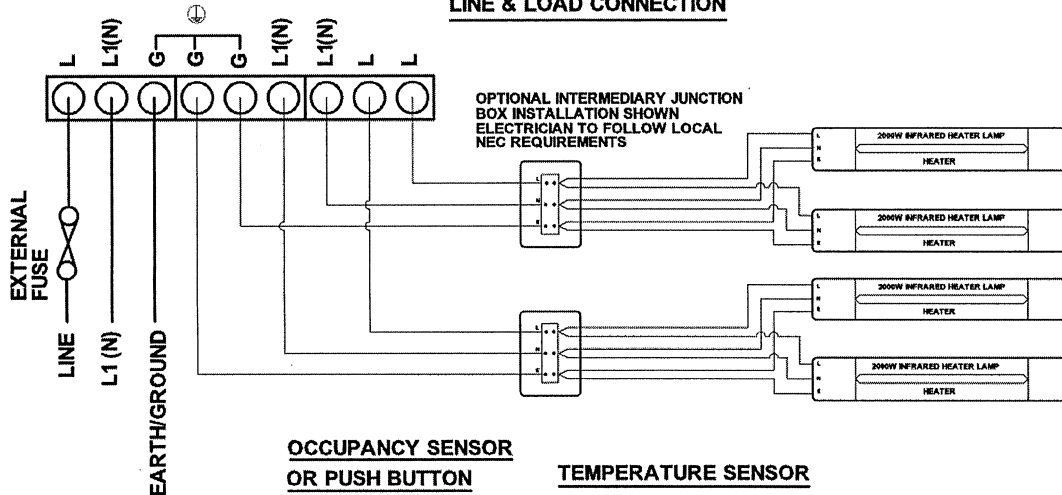

OCCUPANCY SENSOR OR PUSH BUTTON

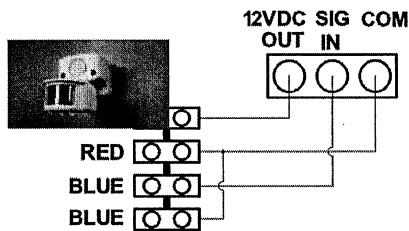

TEMPERATURE SENSOR

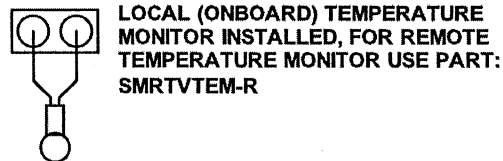

FRONT PANEL



FOR FULL OUTPUT DAB ▲ ONCE, DISPLAY CHANGES TO "F"
TO SWITCH OFF DAB ▼ ONCE, DISPLAY CHANGES TO "0"
TO CHANGE OUTPUT INCREMENTALLY PRESS AND HOLD
▲ OR ▼ AS REQUIRED



TEMPERATURE TRIP SET POINT, THE CONTROLLER SWITCHES
OFF AND THE DISPLAY SHOWS "t" WHEN THE AMBIENT
TEMPERATURE REACHES THIS LEVEL

TROUBLE SHOOTING

Heater does not come on, t in display....The heater pre-set trip temperature IS ABOVE THE AMBIENT TEMPERATURE. This can be adjusted using the temperature set point potentiometer.

Heater does not come on, flashing DOT...The controller is waiting for input from optional occupancy sensor or pushbutton. If your system does not utilize the occupancy sensor or a pushbutton, then wire jumper (factory installed) must be in place in PIR SENSOR INPUT on pins SIG IN and COM. If the jumper is not in place, controller will not operate.

SPECIFICATIONS

Max load at 20°C ambient	8.0kW @ 208-240VAC or 4.0kW @ 120VAC
Voltage	120Vac or 208-240Vac +/- 10%/50/60Hz
Power Consumption	50mA
Occupancy Sensor (option)	See below
Pushbutton Timer (option)	Momentary or Toggle
Set Time Period	1-60 minutes
Temperature Set point	5°C to 25°C
Factory Set Temperature trip point	25°C
2 heater Installation	Must be fitted in Parallel
Ambient Operating Temperature	-20°C to 30°C
IP Rating	IP65
Max Unit Operating Temperature	65°C
Occupancy Sensor (optional)	
Operating Voltage	12V dc
Direction	90° Adjustable
Detection	45' (18 Meters)



WARNING: Solaira SMaRT 34-DV Variable control is a high power electrical device and MUST ONLY BE INSTALLED BY A CERTIFIED ELECTRICIAN TO LOCAL AND NATIONAL ELECTRICAL CODE

Trouble Shooting

Temperature Set Point

Temperature set point allows user to control the MINIMUM TEMPERATURE for heaters to come on. If the ambient temperature is above the pre-set level, the heater control will show "t" and WIL NOT TURN ON. You can reduce the minimum temperature to 5°C

Temperature Sensor Input

For local temperature sensor input and optional remote temperature sensor input. The local temperature sensor is included with all SMaRT 34-DV controllers. If the user wishes NOT to use the temperature monitoring feature, simply disconnect the temperature sensor.

FLASHING DOT ON CONTROL PANEL DISPLAY

If the controller is used WITHOUT OPTIONAL OCCUPANCY SENSOR (PIR, Passive Infrared Sensor) or Pushbutton timer, then "wire jumper" must be installed in pins SIG and COM as shown. If the jumper is not installed, the controller senses an open circuit and will switch OFF. Your controller comes with the jumper installed and it should only be removed when a sensor or pushbutton timer is installed.

Wire jumper installed for use WITHOUT optional Occupancy Sensor (PIR)

12VDC SIG COM
OUT IN
OCC (PIR) SENSOR
OR
PUSHBUTTON

RS-485 SUPPLY OUTPUT
SET SW2 TO REMOTE
COMMS WHEN USING
THIS INPUT

LIMITATION OF LIABILITY

It is understood and agreed that seller's liability whether in contract, in tort, under any warranty, in negligence or otherwise shall not exceed the return of the amount of the purchase price paid by purchaser and under no circumstances shall seller be liable for special, indirect or consequential damages. The price stated for the equipment is a consideration in limiting seller's liability. No action, regardless of form, arising out of the transactions may be brought by purchaser more than one year after the cause of action has accrued.

WARRANTY

1. SOLAIRA CONTROL products are guaranteed to be free from mechanical and electrical defects for a period of one year from date of shipment under normal use and service provided installation is made in accordance with manufacturers' recommendations.
2. Parts deemed defective shall be repaired or replaced at manufacturers option and at manufacturers expense but shall not include foreign or federal excise taxes, state or municipal sale or use taxes, all such taxes not limited to the foregoing being responsibility of the purchaser.
3. No charge for travel and/or mileage will be allowed to purchaser.
4. SOLAIRA reserves the right to make changes in design or make any improvements on any products. The right is always reserved to modify our equipment because of new technology, underwriter's requirements and/or government regulations.
5. The following are not covered under warranty:
 - a. INSTALLATION OF CONTROL BY NON-CERTIFIED ELECTRICIAN.
 - b. Failure from neglect, abuse, careless handling and mis-application of unit.
 - c. Failure to observe guidelines for installation or improper voltage hook-up.
 - d. Failure caused by improper installation and not following local, state/provincial and federal electrical guidelines
 - e. Unless specifically allowed by SOLAIRA CONTROLS, no other charges may be included under warranty.

Notice: Inforesight Consumer Products Inc. website, product information and products can be accessed from Canada and other countries around the world. Customer understands that some or all products provided by Inforesight Consumer Products Inc. may not be available for purchase or installation in certain jurisdictions or geographical areas. Inforesight Consumer Products Inc. reserves the right, in its sole discretion, to exclude or otherwise limit the provision of any product to a person or entity residing in any jurisdiction or geographical area outside of Canada. Inforesight Consumer Products Inc. provides general product information, installation guidelines and procedures and Customer understands that Customer is solely and exclusively responsible for installation of the product and ascertaining all applicable local municipal, provincial, state, and federal NEC (National Electrical Code) rules, by-law, ordinances and guidelines applicable to the installation of any Inforesight Consumer Products Inc. products. Customer must strictly adhere to and be compliant with the local rules, laws, ordinances and legal requirements for the safe installation and use of any Inforesight Consumer Products Inc. products. Instruction manuals are included with the product packaging and copies of our instruction manuals are available upon request. Under no circumstances shall Inforesight Consumer Products Inc. or its affiliated entities, employees, agents, shareholders, officers or directors be liable to Customer or any third party for any product installations and Customer releases Inforesight Consumer Products Inc. from any and all losses, death, personal injury, property damage, other damages, rights, claims, demands and actions of any kind arising from the Customer's installation and use of the product, whether the installation was or was not in accord with the provided instruction manual and/or in compliance with applicable local laws.

Solairat[™] is a registered trademark of Inforesight Consumer Products Inc.

125 Traders Blvd. # 4, Mississauga, Ontario, Canada, M4Z 2H3

Tel: 905-568-7655, EXT 23 SERVIC, Fax:905-568-7521

info@solairaheaters.com

Revision: Issue 3, September 2016