

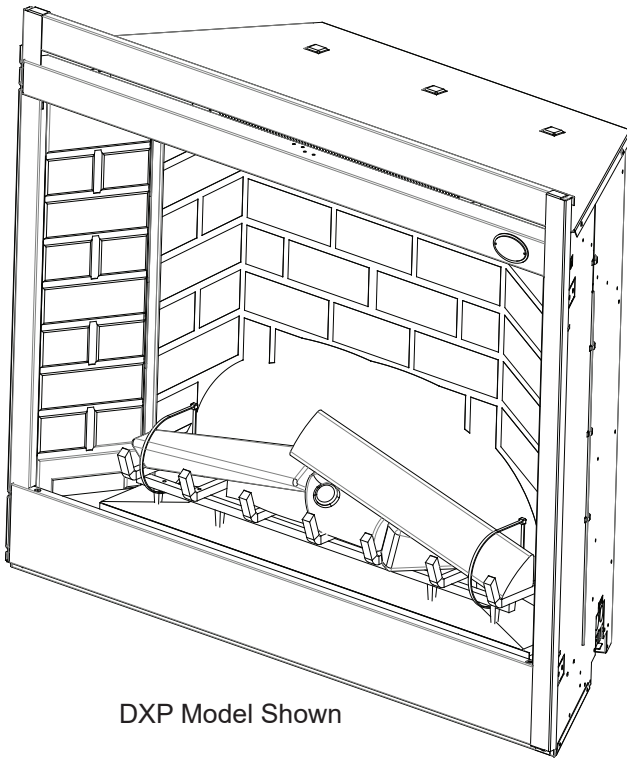

"Click" on the replacement part number to view price and availability.
www.moreelectricheating.com



DXP Model Shown

Service Manual

Model Number	UL Part Number
BF33STP	6901811400
BF33DXP	6901811500
BF39STP	6901811600
BF39DXP	6901811700
BF45DXP	6901811900

IMPORTANT SAFETY INFORMATION: Always read this manual first before attempting to service this fireplace. For your safety, always comply with all warnings and safety instructions contained in this manual to prevent personal injury or property damage.

TABLE OF CONTENTS

Operation	3
Exploded Parts Diagram	6
Wiring Diagram - STP Models	7
Wiring Diagram - DXP Models	8
Switch Replacement - Main On/Off Power; Purifier/Heat; Mode Selector	9
Light Harness Replacement	10
LED Driver Board Replacement - DXP Models Only	10
Flicker Motor & Rod Replacement	11
Blower Replacement	11
Secured in Wall	11
Removable from Wall	12
High Temperature Cutout Replacement	12
Secured in Wall	12
Removable from Wall	13
Element Replacement	13
Secured in Wall	13
Removable from Wall	14
Voltage Selector Switch Replacement	14
Secured in Wall	14
Removable from Wall	14
BFRC-KIT Remote Control Receiver Installation/Replacement	15
WRCPF-KIT Wall Controller Installation/Replacement	15
BF Plug Kit Replacement (BFPLUGE)	16
Assembly Component Pictures	17
Troubleshooting Guide	19

Always use a qualified technician or service agency to repair this fireplace.

! NOTE: Procedures and techniques that are considered important enough to emphasize.

⚠ CAUTION: Procedures and techniques which, if not carefully followed, will result in damage to the equipment.

⚠ WARNING: Procedures and techniques which, if not carefully followed, will expose the user to the risk of fire, serious injury, or death.

Operation

Manual Controls - Without Remote Option

The fireplace can be controlled by the manual switches located on the fireplace (Figure 1).

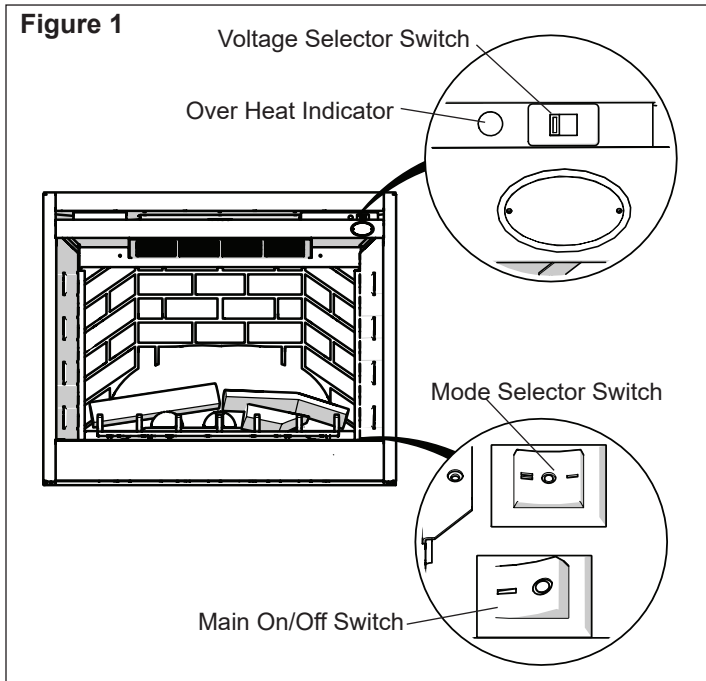

Main Power Switch - Energizes firebox and flame.

Mode Selector Switch:

- Select "o" for flame only
- Select "-" for Purifire™/flame (no heat)
- Select "=" for heat/Purifire™/flame

Voltage Selector Switch

⚠ WARNING: Ensure that the incoming power supply voltage matches the setting of the voltage selector switch.

! NOTE: The voltage selector switch is located inside the exhaust panel on the top right hand corner (Figure 1).

⚠ CAUTION: When changing the voltage selector switch from 240 volts to 120 volts ensure that the power supply is turned off.

! NOTE: Carefully insert a flat head screwdriver inside the exhaust panel to change the switch from 240 volts (230 position) to 120 volts (115 position).

Resetting the Temperature Cutout Switch

The heater on this fireplace is protected with a safety device to prevent overheating. Should the heater overheat, a red light (Figure 1) will be activated and an automatic cut out will turn the heater off. The heater will re-activate once the heater has cooled. The overheat cutout will be triggered if the filter is dirty.

⚠ CAUTION: If you need to continuously reset the heater, disconnect power and call Dimplex customer service at 1-888-DIMPLEX (1-888-346-7539).

Manual Controls - With Remote Accessory (Hand held or Wall Mounted)

The fireplace with the Remote Option has the same manual controls with the addition of the Remote Control Receiver (BFRC-KIT). The Remote Receiver Switch Board which will work in conjunction with the original controls.

The remote control operation can be adjusted, depending on the season and desired effects, by toggling the main mode selector switch built into the fireplace. The position of the switch will dictate the available functions that the remote control will cycle through.

! NOTE: The original controls will override all other settings, both the Mode Selector Switch as well as the Main On/Off Switch. (Figure 2)

A. Manual Selection Switch

Switches the operation of the fireplace between the different modes of the fireplace:

- OFF (center): Makes the unit inoperable.
- MANUAL (top): All functions of the fireplace are controlled by the On and Off buttons as described above (Figure 2B & C).
- REMOTE (bottom): All functions of the fireplace are controlled by the Remote Control.

B. Off Button

Pressing this button toggles sequentially through the three levels of the fireplace. (Only when the selection switch is in the Manual Position)

- Mode Selector Set at "O": Only Flame Effect at all 3 levels.
- Mode Selector Set at "--": Pressing once activates Level 1 - Flame effect only, two and three times activates Level 2 - Flame effect and Purifire™.
- Mode Selector Set at "=": Pressing once activates

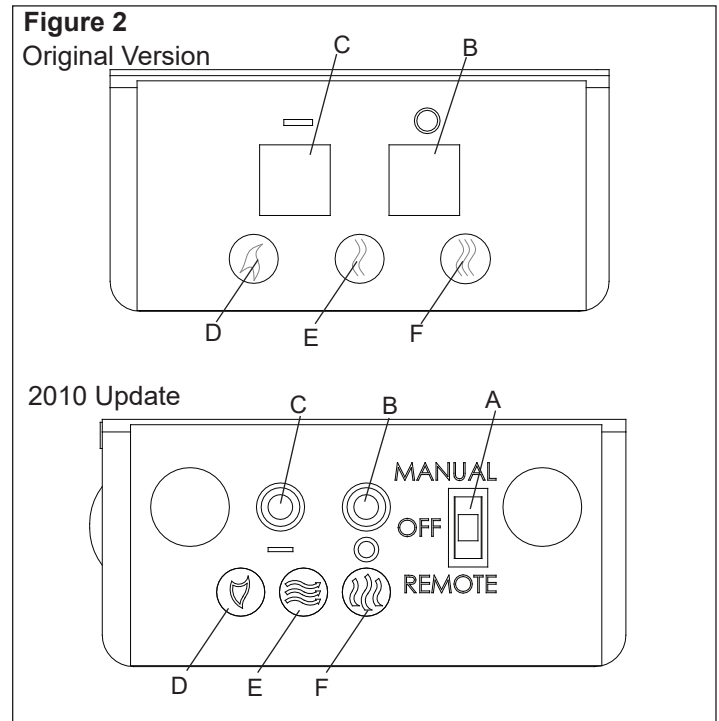

Level 1 - Flame effect only, twice activates Level 2 - Flame effect and Purifire™, three times activates Level 3 - Flame effect, Purifire™ and heat.

C. On Button

Pressing this button at any time will shut the unit off.

D, E & F LED Indicators

Depicts which of the three (3) levels the fireplace is currently operating at: Level 1 - 🔥, Level 2 - 🔥🔥 or Level 3 - 🔥🔥🔥.

Optional Remote Control Operation

The BFRC-KIT is supplied with a radio frequency remote control. This remote control has a range of approximately 50 feet (15.25 m), it does not have to be pointed at the fireplace and can pass through most obstacles (including walls). It is supplied with one of hundreds of independent frequencies to prevent interference with other units.

! NOTE: Before attempting any operation with the remote, pull the plastic insulator strip out from between the remote casing and battery cover (Figure 3).

The remote control operates the fireplace levels sequentially. The level is increased every time the ON button on the remote control is pressed. The fireplace can be turned off at any point by pressing the OFF button on the remote control.

! NOTE: The Mode Selector Switch on the original manual controls needs to be set to “=” to have full functionality of the fireplace. (Figure 2)

Level 1 🔥: The flame effect is turned on and the first red indicator light is activated.

Level 2 🔥🔥: The flame effect remains on, the Purifire is activated. (Heater remains off)

Level 3 🔥🔥🔥: The flame effect remains on, the Purifire is activated and the heater turns on.

Remote Control Initialization/Reprogramming

If the remote control or receiver has been replaced or the remote does not seem to be operating the fireplace, follow these steps to initialize/reprogram the remote control and receiver:

1. Ensure that power is supplied through main service panel.

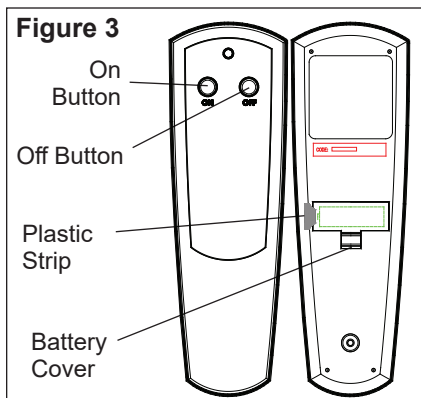

 Battery must be recycled or disposed of properly. Check with your Local Authority or Retailer for recycling advice in your area.

2. Access the manual controls, (remove the glass doors if applicable) pull the right hand steel curtain to the outside of the unit.
3. Locate manual controls.
4. Move the 3-position switch to “Remote”, on newer models only.
5. Activate the main power switch, the red Level 1 Indicator Light may flash 🔥. (Figure 2-D)
6. Press and hold the On button on the manual controls (Figure 2-C) for five (5) seconds. The Level 1 Indicator Light 🔥 (Figure 2-D) will then flash for 10 seconds.
7. **Within** the 10 seconds press the ON button located on the hand held remote control (Figure 3) or any button on the wall mounted controller. This will synchronize the remote control and receiver.

Battery Replacement

To replace the battery:

1. Slide battery cover open on the remote control (Figure 3).
2. Install one (1) 12-Volt (A23) battery in the battery holder.
3. Close the battery cover.

Optional Wall Mounted Remote Operation

! NOTE: For button/display references see Figure 4.

1. **Room Temperature** - Displays current ambient temperature in the room.
2. **Set Temperature** - Displays and controls the heater to the temperature at which the thermostat is currently set to. Press **8** to lower the thermostat and press **9** to raise the thermostat. Pressing both **8** and **9** together will toggle between Celsius and Fahrenheit.
3. **Flame Effect Icon** - The flame icon will flicker if and when the Flame Effect is turned on. Press **11** to turn the Flame Effect on, and press **10** to turn the Flame Effect off.
4. **Purifire™ Icon** - The display arrows for the Purifire™ will cycle when turned on. Press **13** to turn the Purifire™ function on, and press **12** to turn Purifire™ off.
5. **Heat Off Indicator** - This function manually overrides the thermostat control and prevents the fireplace’s heater from coming on.

To do this, press **8** to decrease Set Temperature to any temperature below 0° C or 32° F. To reactivate heat from “HEAT OFF” setting, press **9** to increase the thermostat Set Temperature. The Set Temperature will be displayed starting at 21° C (70° F), replacing the “HEAT OFF” icon.

6. **Function Lock Indicator** - Enabling this function will lock out the Wall Switch Remote Control so as to prevent the current settings from being changed. To Enable, press **8**, **9**, and **10** sequentially. To disengage, press **8**, **9** and **10** sequentially again. The Indicator icon will be displayed when enabled.

7. RF Code Function and Change Procedure - In

the event that the Wall Switch Remote Control does not work properly with the receiver due to interference from additional wireless signals, this function will allow the RF code to be changed.

To enable this function, press **9** and **12** together. “**CODE**” will appear on the display for five (5) seconds and the RF code will change automatically. Repeat procedure as needed to find a code that operates the fireplace without interference.

Re-initialization of the Wall Switch Remote Control will need to take place with receiver after a new code has been activated. See initialization instructions.

14. Low Battery Indicator

When displayed, the indicator will signal that the batteries are low and should be replaced. To further extend battery life, the LED backlighting is turned off when the Low Battery Indicator is displayed.

Other Functions

6 Hour Sleep Timer - This feature ensures all functions are turned off six hours after any last button has been pressed.

To turn this feature on and off press **9**, **11**, **10**, and **8** sequentially.

When activated, “**6 Hr**” will display for 5 seconds while the rest of the LCD remains blank. For the duration of the 6 hour delay, all functions remain working until the 6 hour time delay runs out. The Set Temperature and Room Temperature icons will alternately display their settings and

the “**6 Hr**” icon display. After 6 hours have passed and all functions are turned off, “**6 Hr**” will flash until any button is pressed.

! NOTE: If any button is pressed while this function is enabled, the 6 hour timer will start over for another 6 hour period.

If / when deactivated (pressing the same sequence of buttons again), “**- Hr**” will display for five (5) seconds.

Battery Replacement

To replace the battery:

1. Remove the decora cover from the electrical box and press the wall remote inward until the push-lock releases from the mounting box.
1. Remove the wall remote from the mounting box and slide battery cover open.
2. Install two (2) 1.5V (AAA) battery in the battery holder.
3. Close the battery cover.
4. Reinstall the wall control into mounting box.

Additional Optional Wall Mounted Controls

The fireplace can be installed with wall-mounted controls. These controls include wall switches and thermostats. (See installation guide for specific installation details)

A. Wall Mounted Switches

This model may be installed such that a wall-mounted switch activates the flame effect and a wall mounted heater switch activates the heater. A wall-mounted switch can also be installed to operate the heater independent of the flame.

B. Wall Mounted Thermostat

This unit may be installed with a wall-mounted thermostat which can adjust the heat temperature to your individual requirements. Turn the thermostat control clockwise all the way to turn on the heater. When the room reaches the desired temperature, turn the thermostat knob counter clockwise until you hear a click. Leave in this position to maintain the room temperature at this setting. For additional heat, turn the thermostat clockwise until you hear the click again and the heater will turn on. To turn the heater off, turn the thermostat counter clockwise all the way, and/or turn the manual heater switch on the unit to the OFF position, “O”.

Figure 4

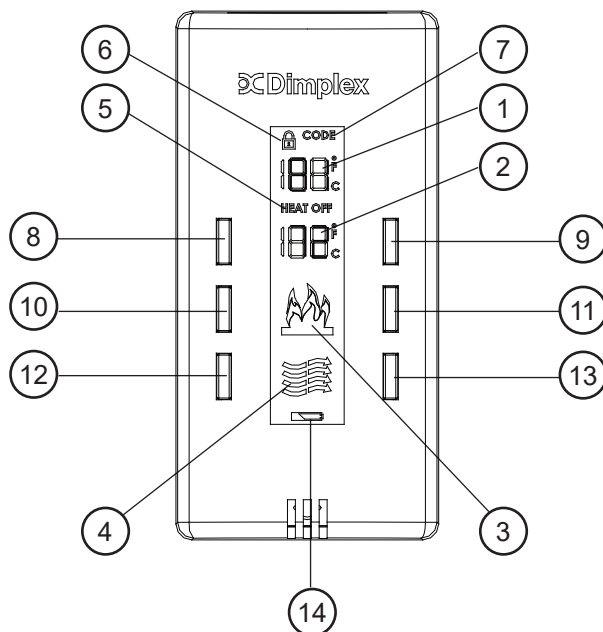

Display

1. Room Temperature
2. Set Temperature
3. Flame Effect
4. Purifire™
5. Heat Off Indicator
6. Function Lock Indicator
7. RF Code Function Indicator

Operation

8. Set Temperature Down
9. Set Temperature Up
10. Flame Off
11. Flame On
12. Purifire™ Off
13. Purifire™ On
14. Low Battery Indicator

Exploded Parts Diagram

"Click" on the replacement part number to view price and availability.
www.morelectrich heating.com

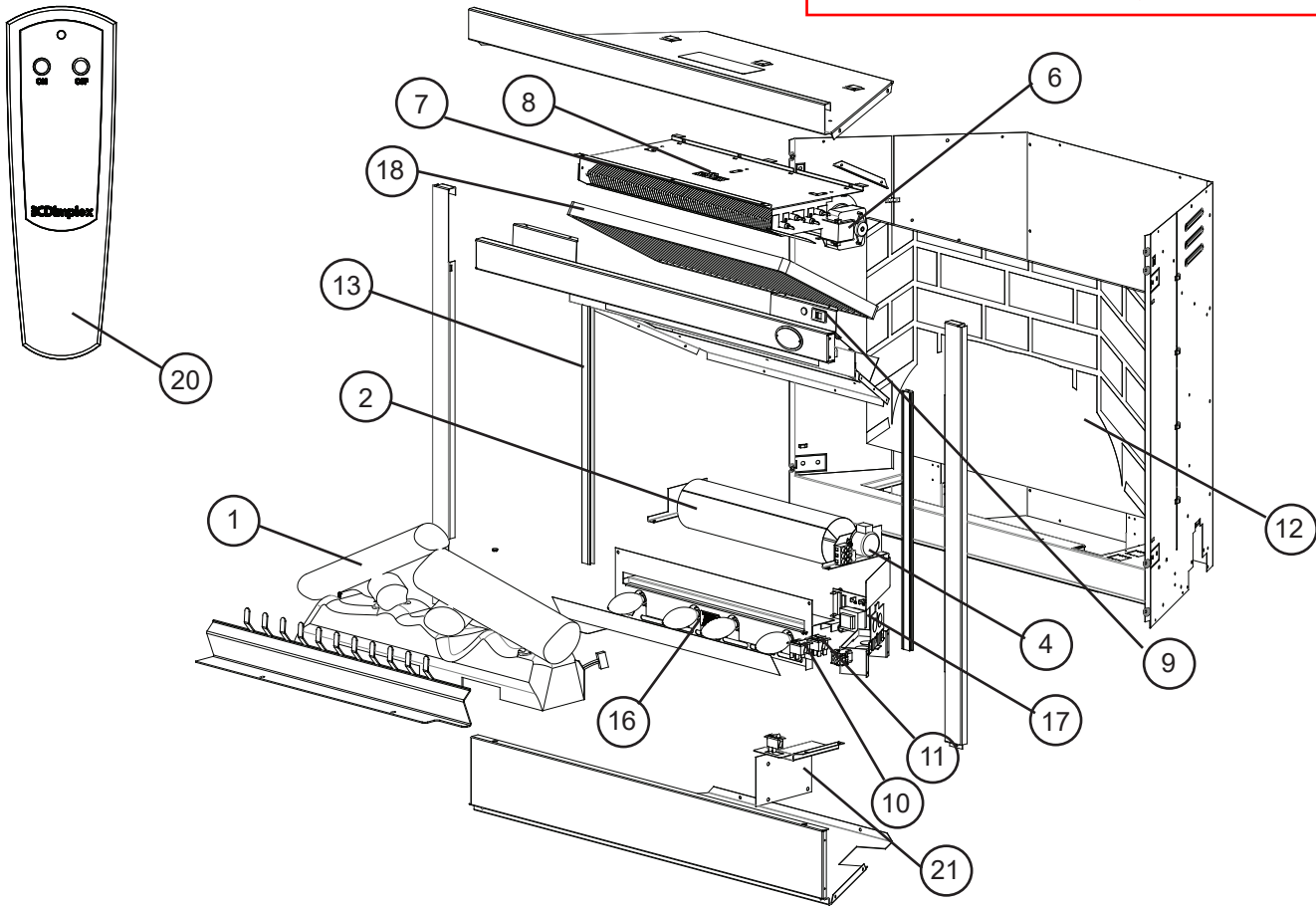

CATALOGUE NUMBER	BF33STP	BF33DXP	BF39STP	BF39DXP	BF45DXP
UL PART NUMBER	6901811400	6901811500	6901811600	6901811700	6901811900
REPLACEMENT PART					
1. LOG SET	0438200700RP	0439230100RP	0438550200RP	0439070100RP	
2. REFLECTOR ROD	5900081000RP			5900080900RP	
3. GROMMET	8500000600RP				
4. FLICKER MOTOR	2000500800RP				
5. FLICKER CONNECTOR	8500680100RP				
6. BLOWER MOTOR	5300160100RP				
7. HEATER ELEMENT	2200510100RP				
8. CUTOUT	2300200900RP		2300200800RP		
9. VOLTAGE SELECTOR (6 WIRE)	2500320100RP	----- VERIFY 6 WIRE OR 3 WIRE AT TIME OF ORDER -----			
VOLTAGE SELECTOR (3 WIRE)	2500320200RP				
10. MAIN ON/OFF SWITCH	2800070400RP				
11. HEAT SWITCH (--/O ORIGINAL)	2800070700RP				
3 POSITION PURIFIRE SWITCH	2800070800RP				
12. PARTIALLY REFLECTIVE GLASS	5900161000RP*	5900161100RP	5900160600RP	5900160700RP	5900160400RP
13. EXTRUSION	N/A		0438650100RP		
14. STEEL CURTAIN	8800240403RP		8800240103RP		8800240203RP
15. STEEL CURTAIN ROD	8800250300RP		8800250100RP		8800250200RP
16. LIGHT HARNESS ASSEMBLY	2500370200RP				
17. SMART LOG DRIVER	N/A	3000390100RP	N/A	3000390100RP	3000390100RP
18. PURIFIRE FILTER REPLACEMENT	0439060100RP				
19. SWING DOOR HARDWARE KIT	9600100100RP				
20. FULL DOOR HARDWARE KIT	9600190100RP				
21. REMOTE CONTROL KIT	BFRC-KIT				
22. WALL MOUNTED REMOTE KIT	WRCPF-KIT				
23. THERMOSTAT	TS321W (SINGLE POLE), TD322W (DOUBLE POLE)				
24. PLUG KIT FOR 120V WALL OUTLET	BFPLUGE				

* 5900161000RP no longer available, 5900161100RP with brick finish can be used as a substitute

Wiring Diagram - STP Models

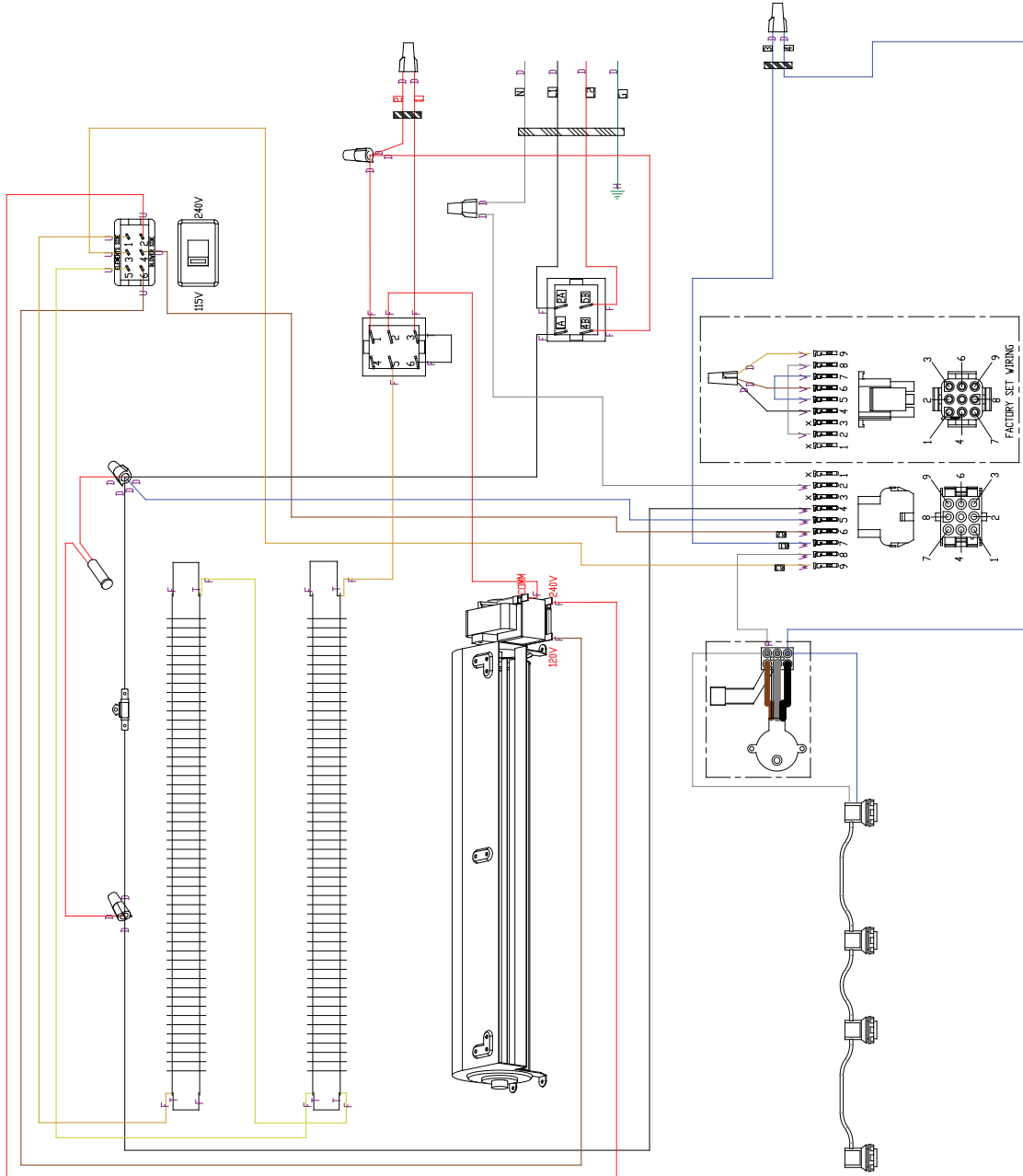
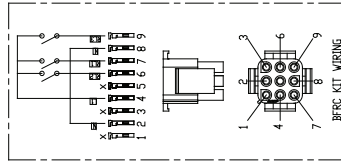
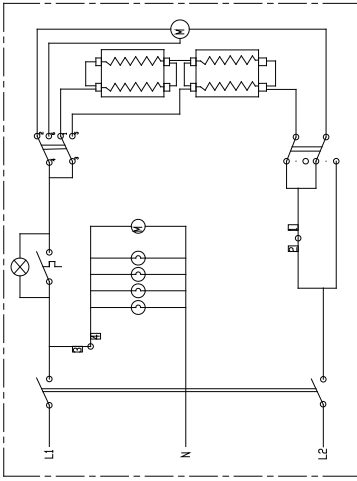

Wiring Diagram - DXP Models

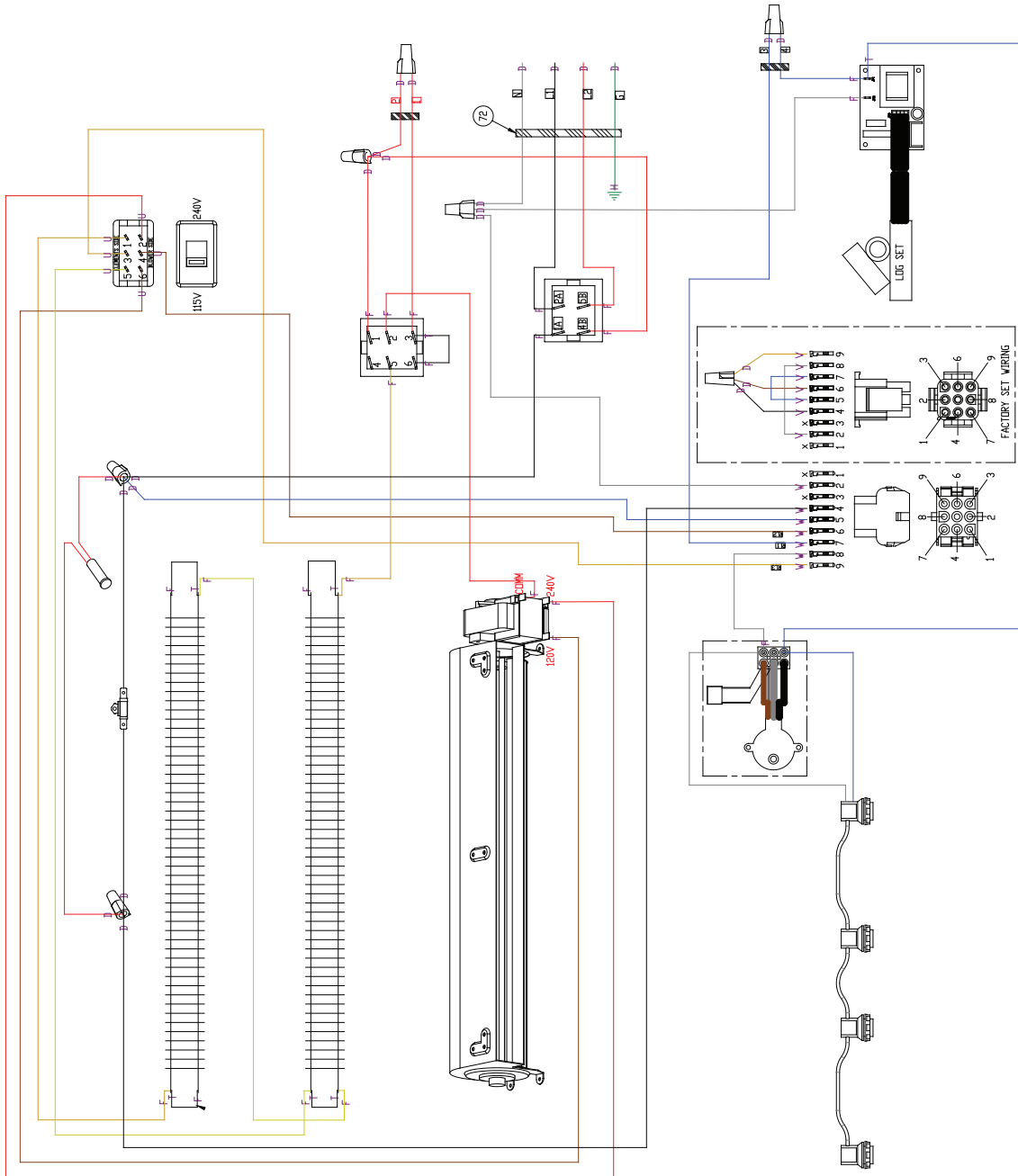
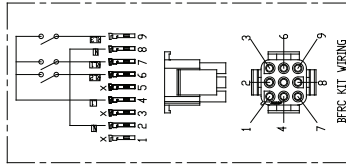
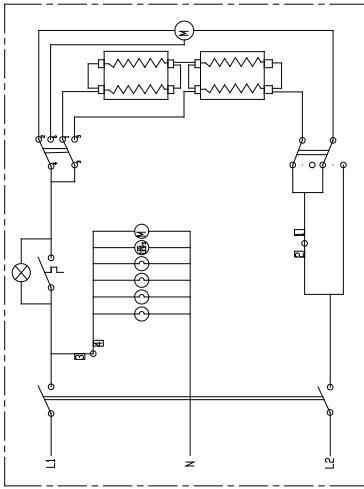

Switch Replacement - Main On/Off Power; Purifier/Heat; Mode Selector

Tools required: Phillips head screwdriver
Flat head screwdriver

! NOTE: Depending on the Modification Level (MOD.) of your fireplace you will have at least two (or a variation) of these types of switches: MAIN ON/OFF POWER; PURI-FIRE/HEAT; MODE SELECTOR, all of which are located in the same area in the firebox and can be replaced following the same instructions below.

⚠ WARNING: If the fireplace was operating prior to servicing allow at least 10 minutes for light bulbs and heating elements to cool off to avoid accidental burning of skin.

⚠ WARNING: Disconnect circuit power before attempting any maintenance or cleaning to reduce the risk of electric shock or damage to persons.

1. Open the steel curtains (remove glass doors if applicable).
2. Remove the 2 screws from the log set retaining plate along the front of the log set and remove the retaining plate..
3. Pull the rear edge of the log set forward by grasping the ember bed by the sides, pull firmly until the rear tab pops out from under the back ledge, then lift the logs out. (Figure 5)

! IMPORTANT: Only handle the log-set by the plastic ember-bed, not the logs themselves.

! NOTE: Log-set fits tightly into firebox. Some force may be necessary to remove.

4. Disconnect the log set LED wire harness from unit. (DXP MODELS ONLY)
5. Locate the removable bracket on the lower right side of the fireplace and remove the 2 mounting screws located to the left of the switches. (Figure 6)
6. Remove the bracket - turn the back edge toward the light bulb about 1/2" (12.7mm) then lift straight up.

! NOTE: For Models with Remote Control Receiver Installed the Plug Connector will have to be disconnected.

Figure 6

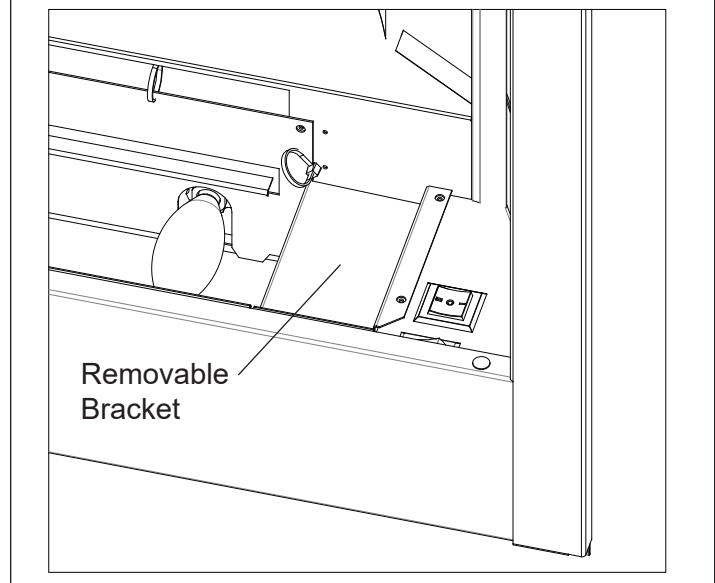

To do this, squeeze the tabs on either side.

7. Reach hand into the opening and locate the switch to be replaced.
8. Depress the retainer clips on both sides of the switch and push the switch out of the top.
9. Disconnect the wiring connections noting their original locations.

! NOTE: Using a flat head screwdriver gently pry between the end of the connector and the switch to release the wires.

10. Properly orient the new switch and reconnect all of the wiring connections.
11. Reassemble in the reverse order as above.

! NOTE: When re-inserting the log-set, insert the front edge first then push the backside of the log-set down until the rear tab snaps under the back partially reflective glass ledge and the logs are resting against the partially reflective glass.

Figure 5

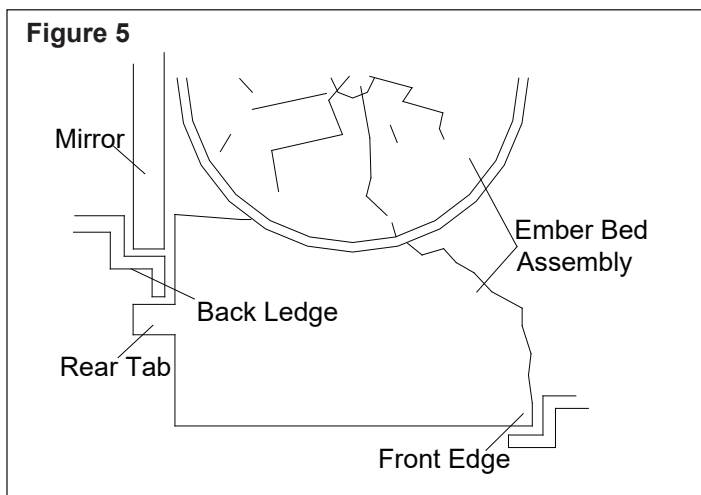

Light Harness Replacement

Tools required: Phillips head screwdriver.
Wire cutters/strippers

⚠ WARNING: If the fireplace was operating prior to servicing allow at least 10 minutes for light bulbs and heating elements to cool off to avoid accidental burning of skin.

⚠ WARNING: Disconnect circuit power before attempting any maintenance or cleaning to reduce the risk of electric shock or damage to persons.

1. Open the steel curtains (remove glass doors if applicable).
2. Remove the 2 screws from the log set retaining plate along the front of the log set and remove the retaining plate.
3. Pull the rear edge of the log set forward by grasping the ember bed by the sides, pull firmly until the rear tab pops out from under the back ledge, then lift the logs out. (Figure 5)

! IMPORTANT: Only handle the log-set by the plastic ember-bed, not the logs themselves.

! NOTE: Log-set fits tightly into firebox. Some force may be necessary to remove.

4. Disconnect the log set LED wire harness from unit. (DXP MODELS ONLY)
5. Remove all lower light bulbs.
6. Remove the 4 retaining screws on the lower light assembly retaining plate and pull it away from the lower panel.
7. Cut the blue and white light harness wires from the old harness at the first socket, which lead inside the firebox. Strip the ends leading inside the firebox by approximately a ½" (12.7 mm).
8. Remove the socket rings that hold the sockets to the light assembly retaining plate by unscrewing the rings counter clockwise.
9. Remove the old sockets and replace with the new sockets and socket rings.
10. Cut the metal ferrules off the end of the blue and white wires from the new light harness and strip them by approximately a ½" (12.7mm).
11. Using a wire-nut, connect the 2 matching wire ends from the old and new harness, matching up the colors (1-blue to 1-blue / 1-white to 1-white).

! NOTE: Connection to the terminal block can only be accessed through additional disassembly therefore an additional electrical junction is recommended in the bottom area.

12. Reassemble in the reverse order as above.

! NOTE: When re-inserting the log-set, insert the front edge first then push the backside of the log-set down until the rear tab snaps under the back partially reflective glass ledge and the logs are resting against the partially reflective glass.

LED Driver Board Replacement - DXP Models Only

Tools Required: Phillips head screwdriver
Needle nose pliers
Flat head screwdriver

⚠ WARNING: If the fireplace was operating prior to servicing allow at least 10 minutes for light bulbs and heating elements to cool off to avoid accidental burning of skin.

⚠ WARNING: Disconnect circuit power before attempting any maintenance or cleaning to reduce the risk of electric shock or damage to persons.

1. Open the steel curtains (remove glass doors if applicable).
2. Remove the 2 screws from the log set retaining plate along the front of the log set and remove the retaining plate.
3. Pull the rear edge of the log set forward by grasping the ember bed by the sides (handle the log set only by the ember bed and not the logs) and pulling firmly until the rear tab pops out from under the back ledge, then lift out. (Figure 5)

! IMPORTANT: Only handle the log-set by the plastic ember-bed, not the logs themselves.

! NOTE: Log-set fits tightly into firebox. Some force may be necessary to remove.

4. Disconnect the log set LED wire harness from unit.
5. Remove the light assembly retaining plate by removing 4 lower light bulbs and the retaining plate screws. Set the retaining plate and light bulbs aside.
6. Reach hand into the opening created by removing the light assembly retaining plate and locate the LED driver board mounted on the lower right side on the back panel.
7. Remove the wires attached to the board noting their original location.

! NOTE: Using a flat head screwdriver gently pry between the end of the connector and the switch to release the wires.

8. Remove the driver board off the 4 mounting clips (one on each corner of the board), by squeezing the tips of the mounting clips with needle nose pliers. Squeeze them just enough to pull the board off. These clips will be re-used to secure the new board.
9. Line up the mounting holes on the new board to the clips and press the new board in place.
10. Install wires on new board in the original configuration.
11. Re-assemble in reverse order as above.

! NOTE: When re-inserting the log-set, insert the front edge first then push the backside of the log-set down until the rear tab snaps under the back partially reflective glass ledge and the logs are resting against the partially reflective glass.

Flicker Motor & Rod Replacement

Tools Required: Phillips head screw driver
1/4" (5.5 mm) ratchet/socket or wrench

⚠ WARNING: If the fireplace was operating prior to servicing allow at least 10 minutes for light bulbs and heating elements to cool off to avoid accidental burning of skin.

⚠ WARNING: Disconnect circuit power before attempting any maintenance or cleaning to reduce the risk of electric shock or damage to persons.

1. Open the steel curtains (remove glass doors if applicable).
2. Remove the 2 screws from the log set retaining plate along the front of the log set and remove the retaining plate.
3. Pull the rear edge of the log set forward by grasping the ember bed by the sides (handle the log set only by the ember bed and not the logs) and pulling firmly until the rear tab pops out from under the back ledge, then lift out. (Figure 5)

! IMPORTANT: Only handle the log-set by the plastic ember-bed, not the logs themselves.

! NOTE: Log-set fits tightly into firebox. Some force may be necessary to remove.

4. Disconnect the log set LED wire harness from unit. (DXP MODELS ONLY)
5. Remove the 4 lower light bulbs and the light assembly retaining plate screws. Set the retaining plate and light bulbs aside.
6. Reach hand into the opening created by removing the light assembly retaining plate and locate the flicker assembly, the assembly runs horizontally across the middle of the unit parallel with the floor (cannot be seen from the front opening). The assembly is secured with two brackets, one on either side.
7. Remove the flicker assembly mounting bracket on the right side (the same side as the controls), using a 1/4" (5.5mm) hex head ratchet/socket or wrench.
8. Remove the flicker rod from the flicker assembly by pulling the rubber channel section of the rod (located on the left side of the bracket) away from the flicker motor.

! NOTE: Once the screw holding the flicker assembly mounting bracket has been removed you can also turn the motor and remove the left end of the flicker rod, to remove the rubber channel. When doing this be careful not to bend the flicker rod as when the unit is reassembled the flame may not function properly.

9. Rotate the flicker motor assembly down releasing the angled mounting tab on the bracket from the rear panel of the fireplace.

! NOTE: In order for the mounting tab to release from the rear panel, the flicker assembly mounting bracket needs to be rotated a complete 90° down. Cutting of the

wire tie wraps may also be required to move wires out of the way.

10. Disconnect the wiring connections from the terminal block noting their original locations.
 - a) If the new flicker motor has 3 wires: disconnect the wiring connections noting their original locations.
 - b) If the new flicker motor has 2 wires: disconnect the wiring connections and the capacitor, install the 2 wires in the two holes where the capacitor was installed.
11. Remove the two mounting screws on either side of the motor and replace with the new one.
12. Properly orient the new motor and reconnect all of the wiring connections.
13. Reassemble in the reverse order as above.

! NOTE: Be sure to secure the flicker rod to the flicker motor prior to securing flicker motor assembly bracket to flame panel. Use wire ties to ensure wires do not come in contact with moving parts.

! NOTE: When re-inserting the log-set, insert the front edge first then push the backside of the log-set down until the rear tab snaps under the back partially reflective glass ledge and the logs are resting against the partially reflective glass.

Blower Replacement SECURED IN WALL

Tools Required: Philips head screwdriver
Flat head screwdriver
Needle nose pliers

⚠ WARNING: If the fireplace was operating prior to servicing allow at least 10 minutes for light bulbs and heating elements to cool off to avoid accidental burning of skin.

⚠ WARNING: Disconnect circuit power before attempting any maintenance or cleaning to reduce the risk of electric shock or damage to persons.

1. Open the steel curtains (remove glass doors if applicable).
2. Remove the 2 screws from the log set retaining plate along the front of the log set and remove the retaining plate.
3. Pull the rear edge of the log set forward by grasping the ember bed by the sides, pull firmly until the rear tab pops out from under the back ledge, then lift the logs out. (Figure 5)

! IMPORTANT: Only handle the log-set by the plastic ember-bed, not the logs themselves.

! NOTE: Log-set fits tightly into firebox. Some force may be necessary to remove.

4. Disconnect the log set LED wire harness from unit. (DXP MODELS ONLY)
5. Release the steel curtains from the side panels by opening the retainers on the sides of the fireplace using

needle nose pliers.

6. Remove the steel curtains by lifting up on the curtain mounting rod releasing it from the side mounting tab, and pulling out.
7. Remove the 2 filter retaining screws and remove the filter and retaining plate.
8. Remove the 10 mounting screws from inside the fire-box that secures the interior top panel and remove the heater cover.
9. Remove the 3 heater assembly mounting screws from underneath the top panel along the front.
10. Lower the heater assembly so that the 3 support tabs, in the top panel, can be easily released.
11. Remove wiring connections from blower motor noting their original locations.

! NOTE: Using a flat head screwdriver gently pry between the end of the connector and the blower/motor to release the wires.

12. Remove the 6 blower motor assembly screws and set aside blower motor assembly.
13. Properly orient the replacement blower assembly and reconnect all of the wiring connections in their original locations.
14. Reassemble in the reverse order as above.

! NOTE: When re-inserting the log-set, insert the front edge first then push the backside of the log-set down until the rear tab snaps under the back partially reflective glass ledge and the logs are resting against the partially reflective glass.

REMOVABLE FROM WALL

Tools Required: Philips head screwdriver
Flat head screwdriver

⚠ WARNING: If the fireplace was operating prior to servicing allow at least 10 minutes for light bulbs and heating elements to cool off to avoid accidental burning of skin.

⚠ WARNING: Disconnect circuit power before attempting any maintenance or cleaning to reduce the risk of electric shock or damage to persons.

1. Remove unit from installed wall (remove trim surround, if applicable).
2. Remove the outer top panel mounting screws, (3 left side, 3 back, 3 right side). Lift the panel off the firebox and position heater assembly upright being careful not to damage any wires.
3. Remove the 3 heater assembly mounting screws from underneath the top panel along the front.
4. Lower the heater assembly so that the 3 support tabs, in the top panel, can be easily released.
5. Remove the 6 blower motor assembly screws and set aside blower motor assembly.
6. Remove the wires attached to the blower/motor noting their original location.

! NOTE: Using a flat head screwdriver gently pry between the end of the connector and the blower/motor to release the wires.

7. Properly orient the replacement blower assembly and reconnect all of the wiring connections in their original locations.
8. Reassemble in the reverse order as above.

High Temperature Cutout Replacement SECURED IN WALL

Tools Required: Philips head screwdriver
Needle nose pliers

⚠ WARNING: If the fireplace was operating prior to servicing allow at least 10 minutes for light bulbs and heating elements to cool off to avoid accidental burning of skin.

⚠ WARNING: Disconnect circuit power before attempting any maintenance or cleaning to reduce the risk of electric shock or damage to persons.

1. Open the steel curtains (remove glass doors if applicable).
2. Remove the 2 screws from the log set retaining plate along the front of the log set and remove the retaining plate.
3. Pull the rear edge of the log set forward by grasping the ember bed by the sides, pull firmly until the rear tab pops out from under the back ledge, then lift the logs out. (Figure 5)

! IMPORTANT: Only handle the log-set by the plastic ember-bed, not the logs themselves.

! NOTE: Log-set fits tightly into firebox. Some force may be necessary to remove.

4. Disconnect the log set LED wire harness from unit. (DXP MODELS ONLY)
5. Release the steel curtains from the side panels by opening the retainers on the sides of the fireplace using needle nose pliers.
6. Remove the steel curtains by lifting up on the curtain mounting-rod releasing it from the side mounting tab, and pulling out.
7. Remove the 2 filter retaining screws and remove the filter and retaining plate.
8. Remove the 10 mounting screws from inside the fire-box that secures the interior top panel and remove the heater cover.
9. Remove the 3 heater assembly mounting screws from underneath the top panel along the front.
10. Lower the heater assembly so that the 3 support tabs, in the top panel, can be easily released.
11. Remove temperature limit switch screw from heater bracket assembly and disconnect the temperature limit switch wire from heater element and from the wire connectors, noting their original location.

12. Properly orient the new temperature limit switch and secure it to the heater bracket assembly with the small screw from the original cutout.
13. Reconnect the wires in their original locations.
14. Reassemble in the reverse order as above.

⚠ WARNING: Ensure wires do not come in contact with moving parts by securing wires in tie wraps.

! NOTE: When re-inserting the log-set, insert the front edge first then push the backside of the log-set down until the rear tab snaps under the back partially reflective glass ledge and the logs are resting against the partially reflective glass.

REMOVABLE FROM WALL

Tools Required: Philips head screwdriver

⚠ WARNING: If the fireplace was operating prior to servicing allow at least 10 minutes for light bulbs and heating elements to cool off to avoid accidental burning of skin.

⚠ WARNING: Disconnect circuit power before attempting any maintenance or cleaning to reduce the risk of electric shock or damage to persons.

1. Remove unit from installed wall (remove trim surround, if applicable).
2. Remove the outer top panel mounting screws, (3 left side, 3 back, 3 right side). Lift the panel off the firebox and position heater assembly upright being careful not to damage any wires.
3. Remove the 3 heater assembly mounting screws from underneath the top panel along the front.
4. Lower the heater assembly so that the 3 support tabs, in the top panel, can be easily released.
5. Remove temperature limit switch screw from heater bracket assembly and disconnect the temperature limit switch wire from heater element and from the wire connectors, noting their original location.

! NOTE: To reconnect temperature limit switch, cut and strip the long end of the cutout wire, and wire connect to existing cutout wire closest to blower motor.

6. Properly orient the new temperature limit switch and secure to heater bracket assembly.
7. Reconnect the wires in their original locations.
8. Reassemble in the reverse order as above.

⚠ WARNING: Ensure wires do not come in contact with moving parts by securing wires in tie wraps.

Element Replacement SECURED IN WALL

Tools Required: Philips head screwdriver
 $\frac{3}{8}$ " Hex head socket or ratchet
 Needle nose pliers

⚠ WARNING: If the fireplace was operating prior to servicing allow at least 10 minutes for light bulbs and heating elements to cool off to avoid accidental burning of skin.

⚠ WARNING: Disconnect circuit power before attempting any maintenance or cleaning to reduce the risk of electric shock or damage to persons.

! NOTE: The fireplace is equipped with two heating elements. The same removal and installation instructions apply to both elements.

1. Open the steel curtains (remove glass doors if applicable).
2. Remove the 2 screws from the log set retaining plate along the front of the log set and remove the retaining plate.
3. Pull the rear edge of the log set forward by grasping the ember bed by the sides, pull firmly until the rear tab pops out from under the back ledge, then lift the logs out. (Figure 5)

! IMPORTANT: Only handle the log-set by the plastic ember-bed, not the logs themselves.

! NOTE: Log-set fits tightly into firebox. Some force may be necessary to remove.

4. Disconnect the log set LED wire harness from unit. (DXP MODELS ONLY)
5. Release the steel curtains from the side panels by opening the retainers on the sides of the fireplace using needle nose pliers.
6. Remove the steel curtains by lifting up on the curtain mounting rod releasing it from the side mounting tab, and pulling out.
7. Remove the 2 filter retaining screws and remove the filter and retaining plate.
8. Remove the 10 mounting screws from inside the firebox that secures the interior top panel and remove the heater cover.
9. Locate the elements mounted to the top cover, pull the sheathing back and disconnect the connections noting their original locations.
10. Remove the 2 element cover hex head screws on the right using a $\frac{3}{8}$ " Hex head socket.
11. Remove the 3 remaining element cover mounting screws on the left and remove element.
12. Properly orient the replacement element and reconnect all of the wiring connections in their original locations.
13. Reassemble in the reverse order as above.

! NOTE: When re-inserting the log-set, insert the front edge first then push the backside of the log-set down until

the rear tab snaps under the back partially reflective glass ledge and the logs are resting against the partially reflective glass.

REMOVABLE FROM WALL

Tools Required: Philips head screwdriver
3/8" Hex head socket or ratchet
Needle nose pliers

⚠ WARNING: If the fireplace was operating prior to servicing allow at least 10 minutes for light bulbs and heating elements to cool off to avoid accidental burning of skin.

⚠ WARNING: Disconnect circuit power before attempting any maintenance or cleaning to reduce the risk of electric shock or damage to persons.

! NOTE: The fireplace is equipped with two heating elements. The same removal and installation instructions apply to both elements.

1. Remove unit from installed wall. (Remove trim surround if applicable).
2. Remove the outer top panel mounting screws, (3-left side, 3-back, 3-right side). Lift the panel off the firebox and position heater assembly upright being careful not to damage any wires.
3. Locate the elements mounted to the top cover, pull back the sheathing and disconnect the connections noting their original locations.
4. Remove the 2 element cover hex head screws on the right using a 3/8" Hex head socket.
5. Remove the 3 remaining element cover mounting screws on the left and remove element.
6. Properly orient the replacement element and reconnect all of the wiring connections in their original locations.
7. Reassemble in the reverse order as above.

Voltage Selector Switch Replacement SECURED IN WALL

Tools Required: Philips head screwdriver
Flat head screwdriver
Wire cutters/strippers
Needle nose pliers

⚠ WARNING: If the fireplace was operating prior to servicing allow at least 10 minutes for light bulbs and heating elements to cool off to avoid accidental burning of skin.

⚠ WARNING: Disconnect circuit power before attempting any maintenance or cleaning to reduce the risk of electric shock or damage to persons.

1. Remove the log grate retaining screws and remove the log grate.
2. Pull the rear edge of the log set forward by grasping the ember bed by the sides (handle the log set only by the ember bed and not the logs) and pulling firmly until the rear tab pops out from under the back ledge, then

lift out. (Figure 5)

! IMPORTANT: Only handle the log-set by the plastic ember-bed, not the logs themselves.

! NOTE: Log-set fits tightly into firebox. Some force may be necessary to remove.

3. Disconnect the log set LED wire harness from unit. (DXP MODELS ONLY)
4. Release the steel curtains from the side panels by opening the retainers on the sides of the fireplace using needle nose pliers.
5. Remove the steel curtains by lifting up on the curtain mounting-rod releasing it from the side mounting tab, and pulling out.
6. Remove the 2 filter retaining screws and remove the filter and retaining plate.
7. Remove the 10 mounting screws from inside the firebox that secures the interior top panel and remove the heater cover.
8. Remove the 3 heater assembly mounting screws from underneath the top panel along the front.
9. Lower the heater assembly so that the 3 support tabs, in the top panel, can be easily released.
10. Locate the voltage selector switch inside the exhaust panel on the top right hand corner, and cut the wire tie wraps securing the voltage selector switch wires.
11. Remove the voltage selector wire connections from the switch noting their original locations.

! NOTE: Using a flat head screwdriver gently pry between the end of the connector and the switch to release the wires.

12. Depress the retainer clips on the rear of the voltage selector switch and push the switch out of the front vent panel.
13. Properly orient the new switch and reconnect all of the wiring connections.

⚠ WARNING: Ensure wires do not come in contact with moving parts by securing wires in wiring tie wraps.

14. Reassemble in the reverse order as above.

! NOTE: When re-inserting the log-set, insert the front edge first then push the backside of the log-set down until the rear tab snaps under the back partially reflective glass ledge and the logs are resting against the partially reflective glass.

REMOVABLE FROM WALL

Tools Required: Philips head screwdriver
Wire cutters/strippers
Flat head screwdriver
Needle nose pliers

⚠ WARNING: If the fireplace was operating prior to servicing allow at least 10 minutes for light bulbs and heating elements to cool off to avoid accidental burning of skin.

⚠ WARNING: Disconnect circuit power before attempt-

ing any maintenance or cleaning to reduce the risk of electric shock or damage to persons.

1. Remove unit from installed wall (remove trim surround, if applicable).
2. Remove the outer top panel mounting screws, (3-left side, 3-back, 3-right side). Lift the panel off the firebox and position heater assembly upright being careful not to damage any wires.
3. Locate the voltage selector switch inside the exhaust panel on the top right hand corner, and cut the wire tie wraps securing the voltage selector switch wires.
4. Disconnect voltage selector switch wire connections from heater elements noting their original locations.

! NOTE: Using a flat head screwdriver gently pry between the end of the connector and the switch to release the wires.

5. Depress the retainer clips on the rear of the voltage selector switch and push the switch out of the front vent panel.
6. Properly orient the new switch and reconnect all of the wiring connections.

⚠ WARNING: Ensure wires do not come in contact with moving parts by securing wires in wiring tie wraps.

7. Reassemble in the reverse order as above.

BFRC-KIT Remote Control Receiver Installation/Replacement

Tools Required: Philips head screwdriver

⚠ WARNING: If the fireplace was operating prior to servicing allow at least 10 minutes for light bulbs and heating elements to cool off to avoid accidental burning of skin.

⚠ WARNING: Disconnect circuit power before attempting any maintenance or cleaning to reduce the risk of electric shock or damage to persons.

1. Open the steel curtains (remove glass doors if applicable).
2. Remove the log retaining plate/grate located on the lower panel along the front base of the log set, by removing the screws that secure the plate to the firebox.
3. Pull the rear edge of the log set forward by grasping the ember bed by the sides (handle the log set only by the ember bed and not the logs) and pulling firmly until the rear tab pops out from under the back ledge, then lift out. (Figure 5)

! IMPORTANT: Only handle the log-set by the plastic ember-bed, not the logs themselves.

! NOTE: Log-set fits tightly into firebox. Some force may be necessary to remove.

4. Disconnect the log set LED wire harness from unit. (DXP MODELS ONLY)
5. Locate the removable bracket on the lower right side

of the fireplace and remove the 2 mounting screws located to the left of the manual switches.

6. Remove the bracket - turn the back edge toward the light bulb about 1/2" (12.7mm) then lift straight up.
7. Depressing both tabs on either side of the quick connect plug and unplug it from the unit.
8. Locate the plug connector on the new assembly.
9. Position the antenna wire so that it is under the new bracket, plug in and install the bracket into position.

! NOTE: The plug only will fit in one way so it may need to be rotated to be inserted.

10. Locate and install the two screws on the new remote control panel.
11. Replace the log by inserting front edge and pushing the back down until rear tab snaps under back ledge (Figure 5) and the logs are resting against partially reflective glass.

! NOTE: When re-inserting the log-set, insert the front edge first then push the backside of the log-set down until the rear tab snaps under the back partially reflective glass ledge and the logs are resting against the partially reflective glass.

12. Replace log grate, using two screws previously removed.
13. Initialize the remote control to the new receiver installed in the fireplace as per the instructions included in the remote packaging.

WRCPF-KIT Wall Controller Installation/Replacement

Tools Required: Philips head screwdriver

⚠ WARNING: If the fireplace was operating prior to servicing allow at least 10 minutes for light bulbs and heating elements to cool off to avoid accidental burning of skin.

⚠ WARNING: Disconnect circuit power before attempting any maintenance or cleaning to reduce the risk of electric shock or damage to persons.

1. Open the steel curtains (remove glass doors if applicable).
2. Remove the log retaining plate/grate located on the lower panel along the front base of the log set, by removing the screws that secure the plate to the firebox.
3. Pull the rear edge of the log set forward by grasping the ember bed by the sides (handle the log set only by the ember bed and not the logs) and pulling firmly until the rear tab pops out from under the back ledge, then lift out. (Figure 5)

! IMPORTANT: Only handle the log-set by the plastic ember-bed, not the logs themselves.

! NOTE: Log-set fits tightly into firebox. Some force may be necessary to remove.

4. Disconnect the log set LED wire harness from unit. (DXP MODELS ONLY)
5. Locate the removable bracket on the lower right side of the fireplace and remove the 2 mounting screws located to the left of the switches.
6. Remove the bracket - turn the back edge toward the light bulb about 1/2" (12.7mm) then lift straight up.
7. Depressing both tabs on either side of the plug connector unplug it from the unit.
8. Locate the plug connector on the new assembly.
9. Position the antenna wire so that it is under the new bracket, plug in and install the bracket into position.
10. Locate and install the two screws on the remote control panel.
11. Replace the log by inserting front edge and pushing the back down until rear tab snaps under back ledge (Figure 5) and the logs are resting against partially reflective glass.

! NOTE: When re-inserting the log-set, insert the front edge first then push the backside of the log-set down until the rear tab snaps under the back partially reflective glass ledge and the logs are resting against the partially reflective glass.
12. Replace log grate, using two screws previously removed.
13. Mount the wall controller within a standard electrical device box, located within 50ft (15m) of the firebox and install cover plate. (See included instructions for electrical installation and requirements.)
14. Initialize the remote control to the new receiver installed in the fireplace as per the instructions included in the remote packaging.

BF Plug Kit Replacement (BFPLUGE)

! NOTE: This accessory is only for 110/120V use only.

Tools Required: Philips head screwdriver

⚠ WARNING: If the fireplace was operating prior to servicing allow at least 10 minutes for light bulbs and heating elements to cool off to avoid accidental burning of skin.

⚠ WARNING: Disconnect circuit power before attempting any maintenance or cleaning to reduce the risk of electric shock or damage to persons.

1. Unplug the fireplace from the wall outlet.
2. Locate the voltage selector switch on the top corner of the fireplace and make sure the switch is set to 115 V. (The switch should already be set to 115V from the original installation of this optional accessory cord. Power cord/Plugs are only approved for operation on the BF33, BF39 or BF45 in 110 – 120 volt application. Fireplace must be removable from the wall for access when a plug kit is being used).
3. Loosen the screw securing the junction box cover on the lower right hand side panel toward the back and remove the cover.
4. Pull out the four wires marked L1, L2, N, and G.
5. Replace the black L1 wire from the unit to the non-ribbed L1 wire from the power cord, connect the red L2 and white N wires from the unit to the ribbed or neutral from the power cord. (Wide blade on the plug is the neutral side of the power cord), connect a wire connector to the green ground wire from the unit.
6. Ensure that all wire connections are tight.
7. Re-Install the junction box cover and tighten the screw.
8. Plug the fireplace back into the outlet for power.
9. If fireplace has a BFRC-KIT (remote control kit) used to operate the unit, the remote control may need to be re-synchronized to the fireplace once power has been restored to the fireplace.

ASSEMBLY COMPONENT PICTURES

Left Element Connections

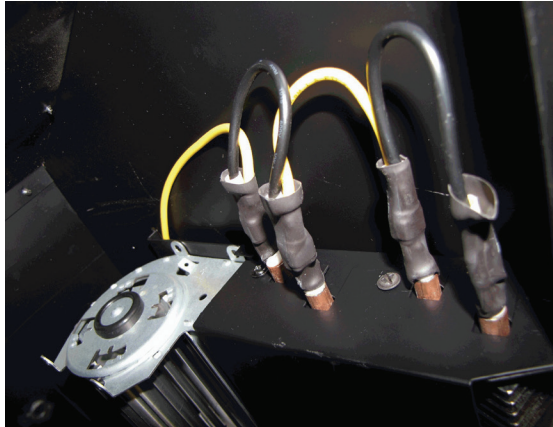

Right Element and Blower Connections

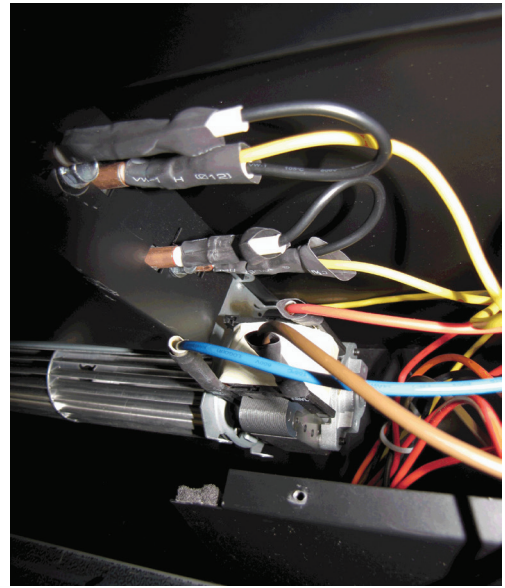

Elements, Blower and Voltage Selector Connections

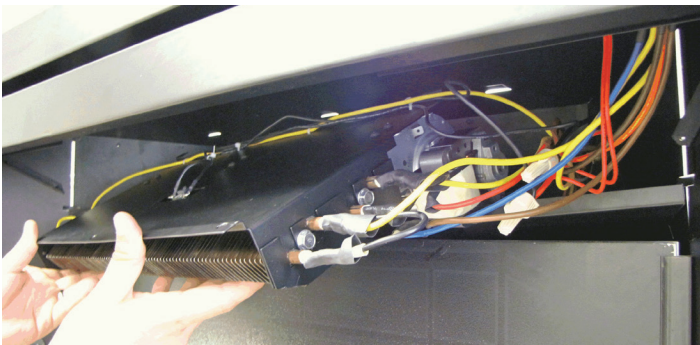

High Temperature Cutout

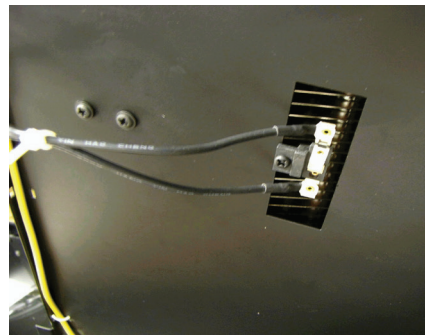

Interior Bottom View of Voltage Selector Switch and Over Temperature Light

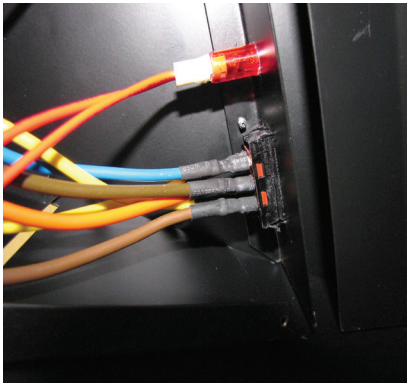

Exterior View of Voltage Selector Switch and Over Temperature Light



LED Driver Board

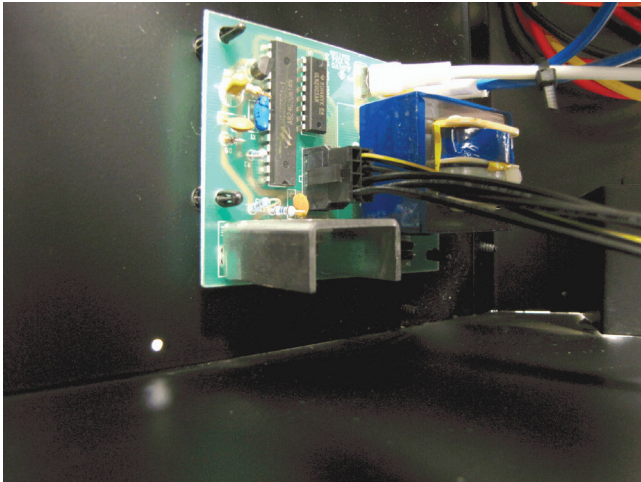

Rear View Light Panel/Harness

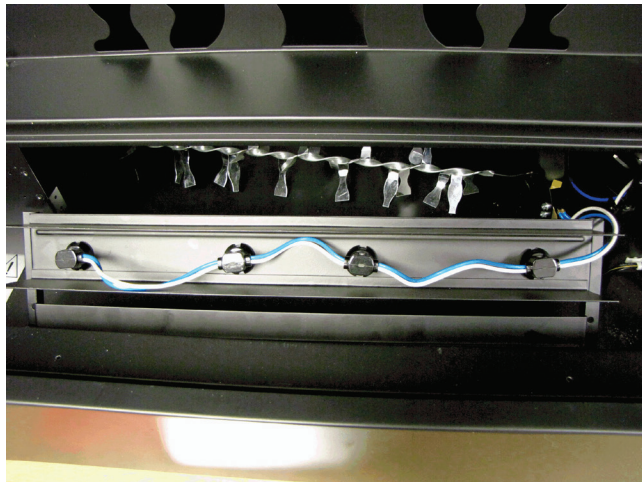

**Manual Controls
with Remote Control Bracket Removed**

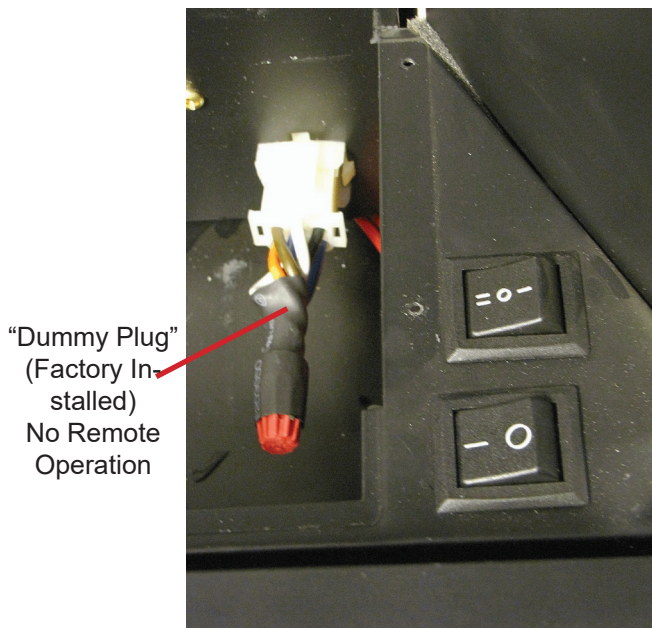

Uninstalled Flicker Motor and Terminal block

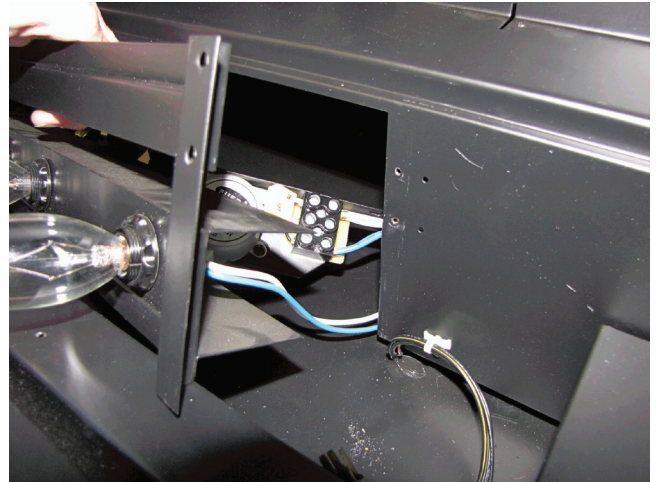

Flicker Rod and Flicker Motor Attachment

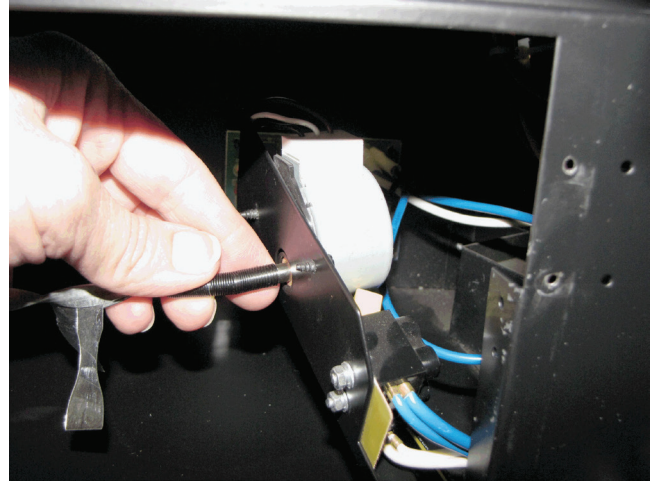

Manual Controls Interior Side View

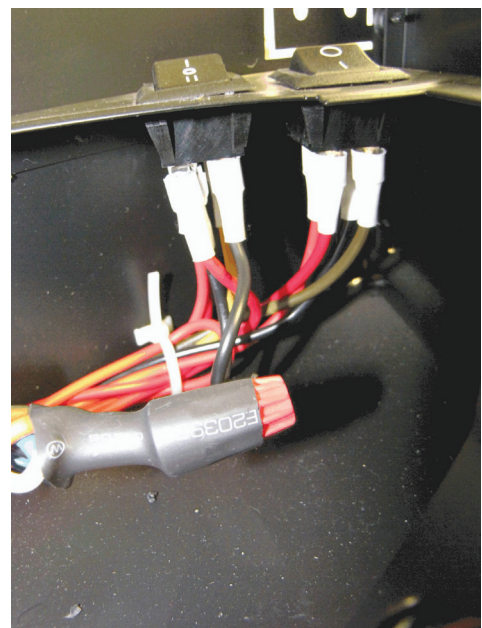

Troubleshooting Guide

PROBLEM	CAUSE	SOLUTION
General		
Circuit breaker trips or fuse blows when unit is turned on	Short in unit wiring.	Trace wiring in unit.
	Improper circuit current rating	Verify unit is installed on a dedicated 15 amp circuit.
Unit turns on or off by itself	Remote control has a similar frequency to other remotes in the area.	Replace remote control
	Wall-mounted remote control has a similar frequency to other remotes in the area.	Change the RF frequency of wall mounted remote and reinitialize. (Instructions found in Operation section)
	Defective remote control receiver kit	Replace remote control receiver kit
Power cord gets warm (if using BFPLUGE kit)	Normal operation	The power cord may get slightly warm to the touch when the heater is on
	Defective power cord	Replace power cord if cord gets hot to the touch.
Appearance		
Fireplace does not turn on Manually	Improper operation	Refer to Operation Section
	Improper installation	Refer to Installation section
	No incoming voltage from the electrical wall socket/breaker panel	Check fuse/breaker panel
	Loose wiring	Check wiring connections
	Defective On/Off Switch	Replace On/Off Switch
Fireplace does not turn on with remote control or wall-mounted remote control (if applicable)	Improper operation	Refer to Operation Section
	Remote control not initialized to fireplace	Initialize the remote control
	Batteries in remote control need to be changed	Install new battery into the remote control. Reinitialize remote where necessary
	Defective remote control	Replace remote control and reinitialize
	Defective remote control receiver kit	Replace remote control receiver kit (BFRC-KIT OR WRCPF-KIT)
Flame Frozen	Defective flicker motor	Replace flicker motor
	Loose wiring	Check wiring connections
Flame not bright or flame not visible	Burnt light bulbs	Replace light bulbs
	Loose wiring	Check wiring connections Refer to Installation section Ensure wires labeled 3 & 4 are connected
	Defective light harness	Replace light harness
	Defective LED driver board (DXP models only)	Replace LED driver board
Log set not glowing/pulsing (DXP models only)	Loose wiring harness	Check wiring connections
	Defective LED Driver Board	LED Driver Board
	Defective log set	Replace log set
Flame Shudder	Defective flicker motor	Replace flicker motor
Light leaking around the log set	Log set not positioned properly	Check log set for proper fit
Noise		
Excessive noise with the heater on	Dirty blower assembly	Ensure that exterior intake louvers and firebox cavity are free of dirt/dust.
	Defective Heater motor	Replace heater motor
Grinding or excessive noise with the heater off	Moving flicker rod hitting or rubbing against internal components	Ensure rod is straight and mounted properly in the bracket, spinning freely away from other components. Replace if necessary.
	Defective flicker motor	Replace flicker motor

PROBLEM	CAUSE	SOLUTION
Heater		
Heater is not turning On	Improper operation	Refer to Operation section
	Improper wiring connection	Refer to Installation Guide For 120v Installation, ensure L2 wire from unit is connected to neutral wires Ensure wires labeled 1 & 2 are connected
	Improper Installation of thermostat/wall controls	Refer to Installation Guide
	Loose wiring	Trace wiring in unit
	Defective 3-position switch	Replace 3-position switch
	Defective remote control receiver kit (if applicable)	Replace remote control receiver kit
	Voltage selector switch is not set on the correct position	Ensure that number visible on voltage selector switch is consistent with incoming power voltage ⚠ WARNING: Setting voltage selector switch to incorrect position may result in damage to unit
	Damage from setting voltage selector switch incorrectly	Correct position of voltage selector switch Replace blower
Heater is not turning Off	Improper operation of unit	Refer to Operation section
	Improper operation of thermostat/wall controls (if applicable)	Refer to thermostat/wall control operation guide
	Defective heater on/off switch	Replace heater on/off switch
	Defective heater assembly	Replace heater assembly
Heater is turning off after a couple of minutes of operation	Build up of dirt/dust in firebox	Ensure that exterior intake louvers and firebox cavity are free of dirt/dust. Clean blower with compressed air.
	Defective blower	Replace blower
Heater emits an odor	Normal operation	Normal operation is when the heater emits an odor for a brief period after the heater is initially turned on. The heater is burning off any dust accumulated during manufacturing or while idle.
	Defective blower	Replace blower
Blower turns on but heater lacks heat	Improper operation	Refer to Operation section. Ensure 3-position switch is set to II
	'No heat' installation	Refer to Installation section Ensure wires labeled 1 & 2 are connected
	Loose wiring	Trace wiring in unit
	Defective heating element	Replace heating element
Heating element is glowing red	Normal Operation	Small glowing sections of the element are considered normal.
	Defective blower	If larger glowing sections are causing the heater to trip the thermal cutout, unplug unit, discontinue use and replace blower.
	Damage from setting voltage selector switch incorrectly	Correct position of voltage selector switch Replace blower

REV PCN DATE

00 - 3-AUG-11
01 14621 29-JAN-16
02 02-JUL-19

1-888-346-7539 | www.dimplex.com

In keeping with our policy of continuous product improvement, we reserve the right to make changes without notice.

© 2019 Glen Dimplex Americas

GlenDimplex
AMERICAS
Enhancing the moments that matter in life