

This catalog contains part numbers for the most common replacement parts for QMARK heaters shown in the Table of Contents. Additional parts for these heaters may be available - consult factory for availability. Parts for QMARK heaters not listed in the Table of Contents may be available - consult factory for availability.

**NOTE:** Parts longer than 8' in length cannot ship UPS. Consult factory for shipping information.

## TABLE OF CONTENTS

<b>BASEBOARD</b>	<b>CEILING HEATERS</b>	<b>RADIANT</b>
Baseboard Accessories ..... 4	QCH ..... 22	ARL ..... 43
CBD ..... 5	EFF ..... 22	BRM ..... 44
HBB ..... 5	CFD ..... 22	CRN ..... 45
QMK (2500 Series) ..... 2		FFR ..... 46
QMKC ..... 2		CHRR ..... 46
	<b>UNIT HEATERS</b>	FRP & FRS ..... 47
<b>WALL HEATERS</b>	CU900 ..... 23	HRK ..... 48
SSAR ..... 6	CHPR25 ..... 25	QHRA & QVRC ..... 49
SSHO ..... 7	IUH ..... 26	RCC ..... 50
HT ..... 8	MEDH ..... 27	
MCSSAR ..... 9	MSDH ..... 28	<b>PORTABLE</b>
AWH & WHFC ..... 10	PRH ..... 29	QPH4A ..... 33
CWH3000 ..... 11	MUH ..... 30	FBE ..... 51
CWH1000 ..... 12	MWUH ..... 32	LFP ..... 51
CWH ARCHITECTURAL SERIES ..... 13	MUH35 ..... 33	FHP ..... 52
LFK ..... 14	TBX ..... 34	WPC ..... 53
GFR ..... 15	QWD ..... 35	
QFG ..... 16		<b>BUILDER PRODUCTS</b>
SED ..... 17	<b>CONVECTORS</b>	BATH VENTS ..... 54
COS-E ..... 18	KCJ ..... 37	GENERAL HOME/KITCHEN ..... 64
EFQ ..... 19	DBA ..... 38	ROOF VENTILATORS ..... 65
ECP ..... 20	SHA ..... 38	WHOLE HOUSE FANS ..... 66
	SLQDB ..... 39	
<b>SPECIALTY HEATERS</b>	ST ..... 40	<b>INDUSTRIAL PRODUCTS</b>
QTS ..... 21	CSH ..... 41	AIR CIRCULATORS ..... 67
FDI ..... 21	DSH ..... 41	DRUM BLOWERS ..... 77
WHT ..... 21	CPH ..... 41	COMMERCIAL CEILING FANS ..... 79
CFWF ..... 21	DPH ..... 41	EXHAUST FANS ..... 80
	DBSL ..... 42	AIR CURTAINS ..... 82

## OBSOLETE PRODUCTS

<b>WALL HEATERS</b>	<b>CONVECTORS</b>	<b>AIR CIRCULATORS</b>
AFA ..... 86	ADB ..... 41	LCHHD ..... 94
CRA ..... 87	APH ..... 41	LCHXN ..... 94
QVP ..... 88	ASH ..... 41	LCHIN ..... 94
A2500 ..... 88	KD/KS ..... 93	
1235 & 2435 ..... 89	QDB ..... 93	
B2400 ..... 89		
CWH2000 ..... 90	<b>RADIANT</b>	
	RDO ..... 94	
<b>UNIT HEATERS</b>	QRH ..... 94	
CU-A ..... 91		
CU-B ..... 91		
VUH ..... 92		
VUH-A ..... 92		

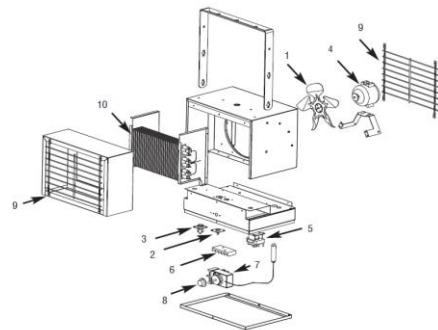

C2500 & 2500 SERIES

ELEMENTS



1802-2001-007	1802-2001-008	1802-2001-009	1802-2001-010	1802-2001-013	1802-2001-014	1802-2001-015	1802-2001-016	1802-2001-019	1802-2001-020	1802-2001-021	1802-2001-022
2573	2543	2503	2513	2574	2544	2504	2514	2575	2545	2505	2515
2573A	2543A	2503A	2513A	2574A	2544A	2504A	2514A	2575A	2545A	2505A	2515A
2573B	2543B	2503B	2513B	2574B	2544B	2504B	2514B	2575B	2545B	2505B	2515B
2573H	2543H	2503H	2513H	2574H	2544H	2504H	2514H	2575H	2545H	2505H	2515H
2573HA	2543HA	2503HA	2513HA	2574HA	2544HA	2504HA	2514HA	2575HA	2545HA	2505HA	2515HA
2573HB	2543HB	2503HB	2513HB	2574HB	2544HB	2504HB	2514HB	2575HB	2545HB	2505HB	2515HB
2573HWA	2543HWA	2503HWA	2513HWA	2574HWA	2544HWA	2504HWA	2514HWA	2575HWA	2545HWA	2505HWA	2515HWA
2573W	2543W	2503W	2513W	2574W	2544W	2504W	2514W	2575W	2545W	2505W	2515W
2573WA	2543WA	2503WA	2513WA	2574WA	2544WA	2504WA	2514WA	2575WA	2545WA	2505WA	2515WA
C2573A	C2543A	C2503A	C2513A	C2574A	C2544A	C2504A	C2514A	C2575A	C2545A	C2505A	C2515A
C2573B	C2543B	C2503B	C2513B	C2574B	C2544B	C2504B	C2514B	C2575B	C2545B	C2505B	C2515B
C2573HA	C2543HA	C2503HA	C2513HA	C2574HB	C2544HA	C2504HA	C2514HA	C2575HA	C2545HA	C2505HA	C2515HA
C2573HB	C2543HWA	C2503HWA	C2513HWA	C2574WA	C2544HWA	C2504HWA	C2514HWA	C2575HWA	C2545HWA	C2505HWA	C2515HWA
C2573HWA	C2543WA	C2503WA	C2513WA	C2574WA	C2544WA	C2504WA	C2514WA	C2575WA	C2545WA	C2505WA	C2515WA
C2573WA											

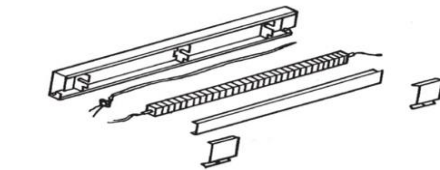









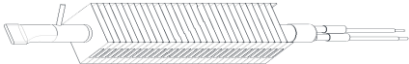

C2500 & 2500 SERIES CONTINUED

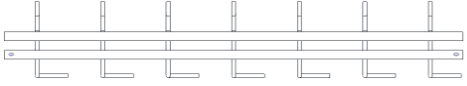
THERMAL CUTOUT





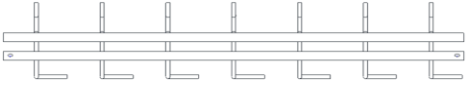





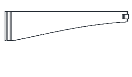
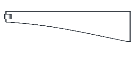

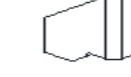
4520-2018-000		4520-2018-001		4520-2018-002		4520-2018-003		4520-2018-004	
2502	2542A	25026	25726NWC	2503	2573NWC	2504	2574NWC	2505	2575NWC
2502A	2542B	25026A	25726W	2503A	2573W	2504A	2574W	2505A	2575W
2502B	2542H	25026B	25726WB	2503B	2573WB	2504B	2574WB	2505B	2575WB
2502NWC	2542NWC	25026NWC	25726WNC	2503NWC	2573WNC	2504NWC	2574WNC	2505NWC	2575WNC
2502W	2542W	25026W	25726WCA	2503W	2573WCA	2504W	2574WCA	2505W	2575WCA
2502WA	2542WA	25026WA	C25026A	2503WA	C2503A	2504WA	C2504A	2505WA	C2505A
2502WB	2542WB	25026WB	C25026B	2503WB	C2503B	2504WB	C2504B	2505WB	C2505B
2502WC	2542WC	25026WC	C25026WC	2503WC	C2503WC	2504WC	C2504WC	2505WC	C2505WC
2502WCA	2542WCA	25026WCA	C25026WCA	2503WCA	C2503WCA	2504WCA	C2504WCA	2505WCA	C2505WCA
2512	2572	25126	C25026W	2513	C2503W	2514	C2504W	2515	C2505W
2512A	2572A	25126A	C25026WA	2513A	C2503WA	2514A	C2504WA	2515A	C2505WA
2512B	2572B	25126B	C25026WCA	2513B	C2503WCA	2514B	C2504WCA	2515B	C2505WCA
2512NWC	2572NWC	25126NWC	C25126A	2513NWC	C2513A	2514NWC	C2514A	2515NWC	C2515A
2512W	2572W	25126W	C25126B	2513W	C2513B	2514W	C2514B	2515W	C2515B
2512WA	2572WA	25126WA	C25126WCA	2513WA	C2513WCA	2514WA	C2514WCA	2515WA	C2515WCA
2512WB	2572WB	25126WB	C25126WB	2513WB	C2513WB	2514WB	C2514WB	2515WB	C2515WB
2512WC	2572WC	25126WC	C25126WC	2513WC	C2513WC	2514WC	C2514WC	2515WC	C2515WC
2512WCA	2572WCA	25126WCA	C25126WCA	2513WCA	C2513WCA	2514WCA	C2514WCA	2515WCA	C2515WCA
2542		25426	C25426A	2543	C2543A	2544	C2544A	2545	C2545A
		25426A	C25426B	2543A	C2543B	2544A	C2544B	2545A	C2545B
		25426B	C25426NWC	2543B	C2543NWC	2544B	C2544NWC	2545B	C2545NWC
		25426NWC	C25426WA	2543NWC	C2543WA	2544NWC	C2544WA	2545NWC	C2545WA
		25426WCA	C25426WB	2543WCA	C2543WB	2544WCA	C2544WB	2545WCA	C2545WB
		25426WB	C25426WC	2543WB	C2543WC	2544WB	C2544WC	2545WB	C2545WC
		25426WCA	C25426WCA	2543WCA	C2543WCA	2544WCA	C2544WCA	2545WCA	C2545WCA
		25426WB	C25426WCA	2543WB	C2543WCA	2544WB	C2544WCA	2545WB	C2545WCA
		25426WC	C25426WB	2543WC	C2543WB	2544WC	C2544WB	2545WC	C2545WB
		25426WCA	C25426WC	2543WCA	C2543WCB	2544WCA	C2544WCB	2545WCA	C2545WCB
		25726	C25726A	2573	C2573A	2574	C2574A	2575	C2575A
		25726A	C25726B	2573A	C2573B	2574A	C2574B	2575A	C2575B
		25726B	C25726NWC	2573B	C2573NWC	2574B	C2574WCA	2575B	C2575WC
		25726WCA	C25726WCA	2573NWC	C2573WCA	2574NWC	C2574WCA	2575NWC	C2575WCA

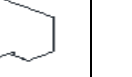

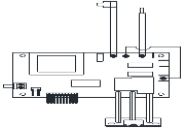

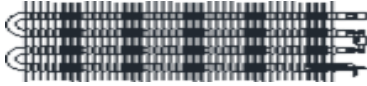
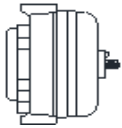

HBB SERIES BASEBOARD											
ELEMENT						LIMIT					
											
1802-2066-000 500D 500DA	1802-2066-001 7500D 7500DA	1802-2068-002 1000D 1000DA	1802-2066-003 1250D 1250DA	1802-2066-004 1500D 1500DA	1802-2068-016 2004D 2004DA	410122002 500D 500DA	410122003 7500D 7500DA	410122004 1000D 1000DA	410122005 1250D 1250DA	410122006 1500D 1500DA	410122008 2004D 2004DA
1802-2068-011 504D 504DA	1802-2068-012 7504D 7504DA	1802-2068-013 1004D 1004DA	1802-2068-014 1254D 1254DA	1802-2068-015 1504D 1504DA	1802-2066-022 2007D 2007DA	504D 504DA	7504D 7504DA	1004D 1004DA	1254D 1254DA	1504D 1504DA	2007D 2007DA
1802-2066-005 508D 508DA	1802-2066-018 7507D 7507DA	1802-2066-019 1007D 1007DA	1802-2066-020 1257D 1257DA	1802-2066-021 1507D 1507DA	1802-2066-010 2008D 2008DA	508D 508DA	7507D 7507DA	1007D 1007DA	1257D 1257DA	1507D 1507DA	2008D 2008DA
	1802-2066-006 7508D 7508DA	1802-2066-007 1008D 1008DA	1802-2066-008 1258D 1258DA	1802-2066-009 1508D 1508DA			7508D 7508DA	1008D 1008DA	1258D 1258DA	1508D 1508DA	
FRONT COVER						GRILLE					
											
1402-2066-000 500D 500DA	1402-2066-001 7500D 7500DA	1402-2066-002 1000D 1000DA	1402-2066-003 1250D 1250DA	1402-2066-004 1500D 1500DA	1402-2066-005 2004D 2004DA	2501-2012-012 500D 500DA	2501-2012-013 7500D 7500DA	2501-2012-014 1000D 1000DA	2501-2012-015 1250D 1250DA	2501-2012-010 1500D 1500DA	2501-2012-011 2004D 2004DA
504D 504DA	7504D 7504DA	1004D 1004DA	1254D 1254DA	1504D 1504DA	2008D 2008DA	504D 504DA	7504D 7504DA	1004D 1004DA	1254D 1254DA	1504D 1504DA	2008D 2008DA
508D 508DA	7507D 7507DA	1007D 1007DA	1257D 1257DA	1507D 1507DA	2007D 2007DA	508D 508DA	7507D 7507DA	1007D 1007DA	1257D 1257DA	1507D 1507DA	2007D 2007DA
	7508D 7508DA	1008D 1008DA	1258D 1258DA	1508D 1508DA			7508D 7508DA	1008D 1008DA	1258D 1258DA	1508D 1508DA	
JUNCTION BOX COVER ALL MODELS 1800-2022-000											
											
CBD SERIES BASEBOARD											
ELEMENT						LIMIT					
											
1802-2056-007 D500 D500A	1802-2056-011 D750 D750A	1802-2063-017 D1000 D1000A	1802-2063-023 D1250 D1250A	1802-2094-015 D1500 D1500A	1802-2063-033 D2004 D2004A	4520-2018-001 D500 D500A	4520-2018-002 D750 D750A	4520-2018-003 D1000 D1000A	4520-2018-004 D1250 D1250A	4520-2018-005 D1500 D1500A	4520-2018-006 D2004 D2004A
1802-2056-005 D504 D504A	1802-2056-009 D754 D754A	1802-2063-015 D1004 D1004A	1802-2063-021 D1254 D1254A	1802-2063-027 D1504 D1504A	1802-2063-032 D2007 D2007A	D504 D504A	D754 D754A	D1004 D1004A	D1254 D1254A	D1504 D1504A	D2007 D2007A
1802-2056-004 D507 D507A	1802-2056-008 D757 D757A	1802-2063-014 D1007 D1007A	1802-2063-047 D1256 D1256A	1802-2063-026 D1507 D1507A	1802-2063-034 D2008 D2008A	D507 D507A	D757 D757A	D1007 D1007A	D1256 D1256A	D1507 D1507A	D2008 D2008A
1802-2056-006 D508 D508A	1802-2056-010 D758 D758A	1802-2063-016 D1008 D1008A	1802-2063-020 D1257 D1257A	1802-2063-028 D1508 D1508A		D508 D508A	D758 D758A	D1008 D1008A	D1257 D1257A	D1508 D1508A	
			1802-2063-022 D1258 D1258A						D1258 D1258A		
FRONT COVER						GRILLE					
											
1402-2066-010 D500 D500A	1402-2066-011 D750 D750A	1402-2066-012 D1000 D1000A	1402-2066-013 D1250 D1250A	1402-2066-014 D1500 D1500A	1402-2066-015 D2004 D2004A	2501-2012-012 D500 D500A	2501-2012-013 D750 D750A	2501-2012-014 D1000 D1000A	2501-2012-015 D1250 D1250A	2501-2012-010 D1500 D1500A	2501-2012-011 D2004 D2004A
D504 D504A	D754 D754A	D1004 D1004A	D1254 D1254A	D1504 D1504A	D2007 D2007A	D504 D504A	D754 D754A	D1004 D1004A	D1254 D1254A	D1504 D1504A	D2007 D2007A
D507 D507A	D757 D757A	D1007 D1007A	D1256 D1256A	D1507 D1507A	D2008 D2008A	D507 D507A	D757 D757A	D1007 D1007A	D1256 D1256A	D1507 D1507A	D2008 D2008A
D508 D508A	D758 D758A	D1008 D1008A	D1257 D1257A	D1508 D1508A		D508 D508A	D758 D758A	D1008 D1008A	D1257 D1257A	D1508 D1508A	
			D1258 D1258A						D1258 D1258A		
JUNCTION BOX COVER ALL MODELS 1800-2022-000											
											
SEE ACCESSORIES ON 2500 SERIES PAGE FOR T1 & T2 THERMOSTAT PARTS											



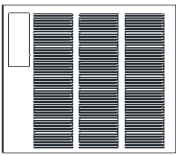
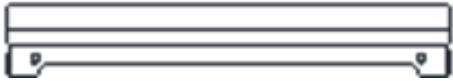

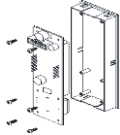
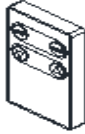
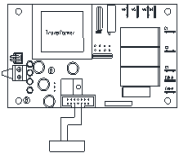
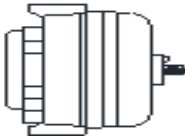

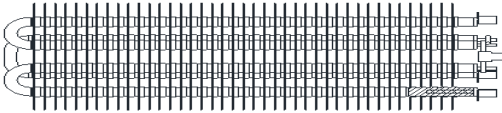
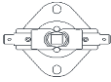
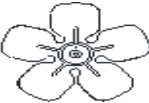
**SSAR SERIES**

RIGHT BEZEL	LEFT BEZEL	DISPLAY ASSM.	BOTTOM BRACKET LT.	BOTTOM BRACKET RT.	REMOTE	EOL LIMIT	FAN BLADE
							
1219-11009-001 ALL MODELS	1219-11009-000 ALL MODELS	1016-11188-000 ALL MODELS	1215-11070-000 ALL MODELS	1215-11070-001 ALL MODELS	1414-11037-000 ALL MODELS	1414-11046-000 ALL MODELS	490030103 ALL MODELS
<b>PWR CONTROL BOARD</b>			<b>DISCONNECT SWITCH</b>	<b>ELEMENT</b>			
							
1414-11033-002 ARWH1802 ARWH1802AL ARWH1802BZ ARWH1802W	1414-11033-001 ARWH4807 ARWH4807AL ARWH4807BZ ARWH4807W	1414-11033-000 ARWH4808 ARWH4804 ARWH4808AL ARWH4804AL ARWH4808BZ ARWH4804BZ ARWH4808W ARWH4804W	410170001 ARWH1802 ARWH1802AL ARWH1802BZ ARWH1802W ARWH4804 ARWH4804AL ARWH4804BZ ARWH4808W ARWH4804W ARWH4807 ARWH4807AL ARWH4807BZ ARWH4807W	302012828 ARWH1802 ARWH1802AL ARWH1802BZ ARWH1802W	1802-2075-801 ARWH4808 ARWH4808AL ARWH4808BZ ARWH4808W	302012810 ARWH4804 ARWH4804AL ARWH4804BZ ARWH4804W	302012811 ARWH4807 ARWH4807AL ARWH4807BZ ARWH4807W
<b>MOTOR</b>							
3900-11026-002 ARWH1802 ARWH1802AL ARWH1802BZ ARWH1802W	3900-11026-001 ARWH4807 ARWH4807AL ARWH4807BZ ARWH4807W	3900-11026-000 ARWH4808 ARWH4804 ARWH4808AL ARWH4804AL ARWH4808BZ ARWH4804BZ ARWH4808W ARWH4804W					
							

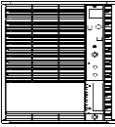
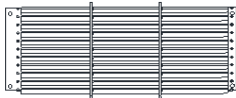
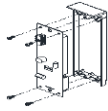
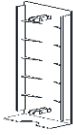
**SSHO SERIES**

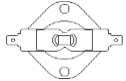
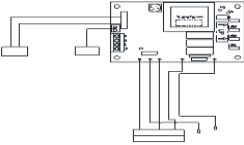
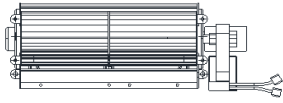



GRILLE			GRILLE TABS (2 REQ)			LIGHT
						
<b>2501-11022-000</b> HOSS4004 HOSS4007 HOSS4008	<b>2501-11022-001</b> HOSS4004SB HOSS4007SB HOSS4008SB	<b>2501-11022-002</b> HOSS4004NV HOSS4007NV HOSS408NV	<b>1402-2120-002</b> HOSS4004 HOSS4007 HOSS4008	<b>1402-2120-001</b> HOSS4004SB HOSS4007SB HOSS4008SB	<b>1402-2120-000</b> HOSS4004NV HOSS4007NV HOSS408NV	<b>3510-2017-005</b> ALL MODELS
DISPLAY ASSM.	REMOTE	CTRL PWR BOARD		MOTOR		DISCONNECT SWITCH
						
<b>1016-11199-000</b> ALL MODELS	<b>1414-11037-000</b> ALL MODELS	<b>1414-11043-000</b> HOSS4004 HOSS4004NV HOSS4004SB HOSS4008 HOSS408NV HOSS4008SB	<b>1414-11043-001</b> HOSS4007 HOSS4007NV HOSS4007SB	<b>3900-2002-522</b> HOSS4004 HOSS4004NV HOSS4004SB HOSS4008 HOSS408NV HOSS4008SB	<b>3900-2002-523</b> HOSS4007 HOSS4007NV HOSS4007SB	<b>410170001</b> ALL MODELS
ELEMENT			MANUAL LIMIT	FAN BLADE		
						
<b>1802-11005-000</b> HOSS4008 HOSS408NV HOSS4008SB	<b>1802-11005-001</b> HOSS4004 HOSS4004NV HOSS4004SB	<b>1802-11005-002</b> HOSS4007 HOSS4007NV HOSS4007SB	<b>4520-2027-000</b> ALL MODELS	<b>490030103</b> ALL MODELS		

**HT SMART SERIES**



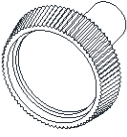
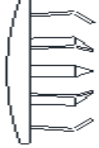
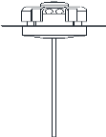
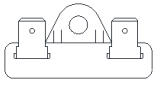
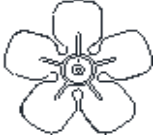

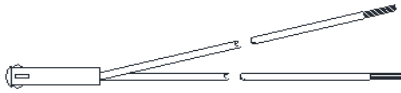
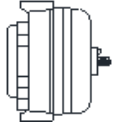
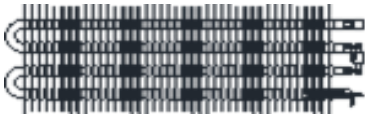







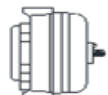

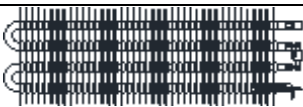
GRILLE PANEL		GRILLE ASSY INSERT		DISPLAY BEZEL	BOTTOM BEZEL	REMOTE	MANUAL LIMIT
							
2501-11003-000 HT1502SS HT2024SS	2501-11003-001 HT1502SSNW HT2024SSNW	1016-11063-000 HT1502SS HT2024SS	1016-11063-001 HT1502SSNW HT2024SSNW	1016-11035-003 HT1502SS HT2024SS HT1502SSNW HT2024SSNW	1219-11004-000 ALL MODELS	1414-11017-000 ALL MODELS	4520-11005-000 ALL MODELS
CNTRL PWR BOARD		BLOWER MOTOR		ELEMENT		LIGHT	
							
1414-11007-002 HT1502SS HT1502SSNW	1414-11007-003 HT2024SS HT2024SSNW	1225-11001-000 HT1502SS HT1502SSNW	1225-11001-001 HT2024SS HT2024SSNW	302023802 HT1502SS HT1502SSNW	302023805 HT2024SS HT2024SSNW	3510-2010-000 HT1502SS HT1502SSNW	3510-2010-001 HT2024SS HT2024SSNW
							



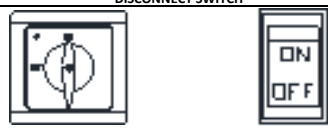







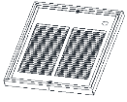
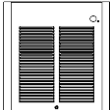

**MCSSAR SERIES**

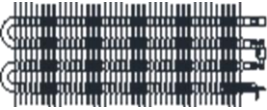
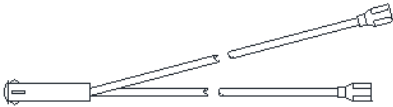
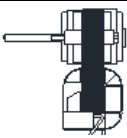
<b>KNOB</b>	<b>PLUG BUTTON</b>	<b>MANUAL RESET</b>	<b>THERMAL FUSE</b>	<b>FAN BLADE</b>	<b>THERMOSTAT</b>
					
<b>3301-11013-000</b> ALL MODELS	<b>4506-2012-009</b> ALL MODELS	<b>4520-11019-000</b> ALL MODELS	<b>4520-2030-00</b> ALL MODELS	<b>490030103</b> ALL MODELS	<b>5813-2027-001</b> ALL MODELS
<b>FAN DELAY</b>			<b>LIGHT</b>		
					
<b>1414-2039-000</b> MCARWH1802 MCARWH1802AL MCARWH1802BZ MCARWH1802W	<b>410074000</b> MCARWH4804 MCARWH4804AL MCARWH4804BZ MCARWH4804W MCARWH4807 MCARWH4807AL MCARWH4808W	MCARWH4807BZ MCARWH4807W MCARWH4808 MCARWH4808AL MCARWH4808BZ MCARWH4808W	<b>3510-2017-000</b> MCARWH1802 MCARWH1802AL MCARWH1802BZ MCARWH1802W	<b>3510-2017-001</b> MCARWH4804 MCARWH4804AL MCARWH4804BZ MCARWH4804W MCARWH4807 MCARWH4807AL	MCARWH4807BZ MCARWH4807W MCARWH4808 MCARWH4808AL MCARWH4808BZ MCARWH4808W
<b>MOTOR</b>			<b>ELEMENT</b>		<b>DISCONNECT SWITCH</b>
					
<b>3900-2010-003</b> MCARWH1802 MCARWH1802AL MCARWH1802BZ MCARWH1802W	<b>3900-2010-000</b> MCARWH4804 MCARWH4804AL MCARWH4804BZ MCARWH4804W MCARWH4808 MCARWH4808AL MCARWH4808BZ MCARWH4808W	<b>3900-2010-001</b> MCARWH4807 MCARWH4807AL MCARWH4807BZ MCARWH4807W	<b>302012828</b> MCARWH1802 MCARWH1802AL MCARWH1802BZ MCARWH1802W  <b>302012811</b> MCARWH4807 MCARWH4807AL MCARWH4807BZ MCARWH4807W	<b>302012810</b> MCARWH4804 MCARWH4804AL MCARWH4804BZ MCARWH4804W  <b>302012807</b> MCARWH4808 MCARWH4808AL MCARWH4808BZ MCARWH4808W	<b>410170001</b> ALL MODELS  

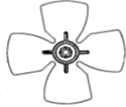

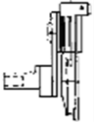

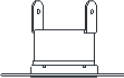







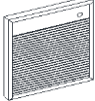

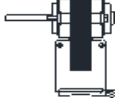
CWH3000 SERIES																			
KNOB				GRILLE				MOTOR		FAN BLADE									
																			
<b>3301-11014-001</b> WHB3150FC WHB3180C WHB3307FC WHB3404FC WHB34043FC WHB3407FC WHB3408FC WHB34083FC WHB3504FC WHB35043FC WHB3507FC WHB3508FC WHB35083FC		<b>3301-2016-000</b> CWH3157A CWH3204A CWH3207A CWH3208A CWH3307A CWH3404A CWH3407A CWH3408A CWH3504A CWH3507A CWH3157A CWH3204A CWH3207A CWH3208A CWH3307A CWH3404A CWH3407A CWH3408A CWH3504A CWH3507A		<b>1016-11226-000</b> WHB3150FC WHB3180C WHB3307FC WHB3404FC WHB34043FC WHB3407FC WHB3408FC WHB34083FC WHB3504FC WHB35043FC WHB3507FC WHB3508FC WHB35083FC		<b>2501-2019-001</b> CWH3157A CWH3204A CWH3207A CWH3208A CWH3307A CWH3404A CWH3407A CWH3408A CWH3504A CWH3507A CWH3157A CWH3204A CWH3207A CWH3208A CWH3307A CWH3404A CWH3407A CWH3408A CWH3504A CWH3507A		<b>3900-2010-001</b> CWH3157A CWH3207A CWH3307A CWH3407A CWH3507A CWH3157A CWH3207A CWH3307A CWH3407A CWH3507A CWH3157A CWH3207A CWH3307A CWH3407A CWH3507A WHB3307FC WHB3407FC WHB3507FC		<b>3900-2010-000</b> CWH3204A CWH3208A CWH3404A CWH3408A CWH3504A CWH3204A CWH3208A CWH3404A CWH3408A CWH3504A CWH3204A CWH3208A CWH3404A CWH3408A CWH3504A CWH3204A CWH3208A CWH3404A CWH3408A CWH3504A		<b>3900-2010-003</b> CWH3150 CWH3180 WHB3150FC WHB3180C <b>3900-2002-510</b> CWH3153BNW CWH3156BNW CWH3203BNW CWH3206BNW <b>3900-2002-519</b> CWH3406 CWH3503 CWH3506 CWH3204BNW CWH3208BNW CWH3404BNW CWH3408BNW WHB3404FC WHB3408FC WHB3504FC		<b>3900-2002-518</b> CWH34043 CWH34083 CWH35043 CWH35083 CWH34043BNW CWH34083BNW CWH35043BNW CWH35083BNW WHB34043FC WHB34083FC WHB35043FC WHB35083FC		<b>490030103</b> ALL MODELS			
<b>ELEMENT</b> 				<b>THERMOSTAT</b> 				<b>MANUAL LIMIT</b> 		<b>TIME DELAY RELAY</b> 									
<b>302015801</b> CWH3208A CWH3208A CWH3208BNW		<b>302015802</b> CWH3204A CWH3204A CWH3204BNW		<b>302015803</b> CWH3207A CWH3207A CWH3207BNW		<b>302015806</b> CWH3157A CWH3157A CWH3157BNW		<b>1802-2075-801</b> CWH35083 CWH3508BNW CWH35083BNW WHB3508FC WHB35083FC		<b>410168002</b> CWH3157A CWH3204A CWH3207A CWH3208A CWH3307A CWH3404A CWH3407A CWH3408A CWH3504A CWH3507A CWH3157A CWH3204A CWH3207A CWH3208A CWH3307A CWH3404A CWH3407A CWH3408A CWH3504A CWH3507A		<b>5813-2059-000</b> CWH3150 CWH3180 CWH3153BNW CWH3157BNW CWH3203BNW CWH3204BNW CWH3206BNW CWH3207BNW CWH3208BNW CWH3303BNW CWH3306BNW CWH3307BNW CWH3308BNW CWH3404BNW CWH3406BNW CWH3407BNW CWH3408BNW CWH3503BNW		<b>4520-2027-000</b> ALL MODELS		<b>410171003</b> CWH3203BNW CWH3206BNW			
<b>302012806</b> CWH3307A CWH3307A CWH3307A CWH3307BNW WHB3307FC		<b>302012807</b> CWH3408A CWH3408A CWH3408A CWH3408BNW WHB3408FC		<b>302012808</b> CWH3404A CWH3404A CWH3404A CWH3404BNW WHB3404FC		<b>302012809</b> CWH3407A CWH3407A CWH3407A CWH3407BNW WHB3407FC		<b>1802-2075-803</b> CWH35043 CWH35043BNW WHB35043FC		<b>410168002</b> CWH3157A CWH3204A CWH3207A CWH3208A CWH3307A CWH3404A CWH3407A CWH3408A CWH3504A CWH3507A CWH3157A CWH3204A CWH3207A CWH3208A CWH3307A CWH3404A CWH3407A CWH3408A CWH3504A CWH3507A		<b>5813-2059-000</b> CWH3150 CWH3180 CWH3153BNW CWH3157BNW CWH3203BNW CWH3204BNW CWH3206BNW CWH3207BNW CWH3208BNW CWH3303BNW CWH3306BNW CWH3307BNW CWH3308BNW CWH3404BNW CWH3406BNW CWH3407BNW CWH3408BNW CWH3503BNW		<b>4520-2027-000</b> ALL MODELS		<b>410171003</b> CWH3203BNW CWH3206BNW			
<b>302012810</b> CWH3504A CWH3504A CWH3504BNW WHB3504FC		<b>302012811</b> CWH3507A CWH3507A CWH3507BNW WHB3507FC		<b>302012823</b> CWH3503 CWH3503BNW <b>302012824</b> CWH3506 CWH3506BNW		<b>302012820</b> CWH3153BNW CWH3506BNW		<b>302012812</b> CWH3508BNW CWH3508BNW		<b>1802-2075-802</b> CWH34043 CWH34043BNW WHB34043FC		<b>410168002</b> CWH3157A CWH3204A CWH3207A CWH3208A CWH3307A CWH3404A CWH3407A CWH3408A CWH3504A CWH3507A CWH3157A CWH3204A CWH3207A CWH3208A CWH3307A CWH3404A CWH3407A CWH3408A CWH3504A CWH3507A		<b>5813-2059-000</b> CWH3150 CWH3180 CWH3153BNW CWH3157BNW CWH3203BNW CWH3204BNW CWH3206BNW CWH3207BNW CWH3208BNW CWH3303BNW CWH3306BNW CWH3307BNW CWH3308BNW CWH3404BNW CWH3406BNW CWH3407BNW CWH3408BNW CWH3503BNW		<b>4520-2027-000</b> ALL MODELS		<b>410171003</b> CWH3203BNW CWH3206BNW	
<b>302012818</b> CWH3206BNW CWH3206BNW		<b>302012821</b> CWH3308BNW CWH3308BNW		<b>302012827</b> CWH3150 WHB3150FC		<b>302012822</b> CWH3150 WHB3150FC		<b>302012819</b> CWH3303BNW CWH3303BNW		<b>410168002</b> CWH3157A CWH3204A CWH3207A CWH3208A CWH3307A CWH3404A CWH3407A CWH3408A CWH3504A CWH3507A CWH3157A CWH3204A CWH3207A CWH3208A CWH3307A CWH3404A CWH3407A CWH3408A CWH3504A CWH3507A		<b>5813-2059-000</b> CWH3150 CWH3180 CWH3153BNW CWH3157BNW CWH3203BNW CWH3204BNW CWH3206BNW CWH3207BNW CWH3208BNW CWH3303BNW CWH3306BNW CWH3307BNW CWH3308BNW CWH3404BNW CWH3406BNW CWH3407BNW CWH3408BNW CWH3503BNW		<b>4520-2027-000</b> ALL MODELS		<b>410171003</b> CWH3203BNW CWH3206BNW			
<b>DISCONNECT SWITCH</b> 				<b>FAN DELAY</b> 				<b>RELAY</b> 		<b>TRANSFORMER</b> 									
<b>5216-2019-000</b> CWH34043 CWH3406 CWH34083 CWH3503 CWH35043 CWH3506 CWH35083 CWH3153BNW CWH3156BNW CWH3203BNW CWH3206BNW CWH3303BNW CWH3306BNW CWH3308BNW CWH34043BNW CWH3406BNW CWH34083BNW CWH3503BNW CWH35043BNW CWH3506BNW CWH3508BNW		<b>410170001</b> CWH3157A CWH3204A CWH3207A CWH3208A CWH3307A CWH3404A CWH3407A CWH3408A CWH3504A CWH3507A CWH3157A CWH3204A CWH3207A CWH3208A CWH3307A CWH3404A CWH3407A CWH3408A CWH3504A CWH3507A		<b>4520-2024-000</b> CWH34043 CWH34083 CWH35043 CWH35083 CWH3153BNW CWH3156BNW		<b>410074000</b> CWH3157A CWH3204A CWH3207A CWH3208A CWH3307A CWH3404A CWH3407A CWH3408A CWH3504A CWH3507A CWH3157A CWH3204A CWH3207A CWH3208A CWH3307A CWH3404A CWH3407A CWH3408A CWH3504A CWH3507A		<b>5018-2017-000</b> CWH34043 CWH35043 CWH3153BNW CWH3156BNW CWH3203BNW CWH3206BNW CWH3303BNW CWH3306BNW CWH3308BNW CWH34043BNW CWH3406BNW CWH34083BNW CWH3503BNW CWH35043BNW CWH3506BNW CWH3508BNW		<b>5018-2017-004</b> CWH34083 CWH35083 CWH34083BNW CWH3508BNW CWH35083BNW WHB34083FC WHB35083FC		<b>490015017</b> CWH3156BNW CWH3206BNW CWH3306BNW CWH3406BNW CWH3506BNW		<b>490015013</b> CWH3153BNW CWH3203BNW CWH3303BNW CWH3308BNW CWH3503BNW					
<b>WHB</b> 		<b>CWH</b> 																	





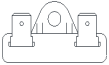
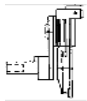





**CWH1000 SERIES**





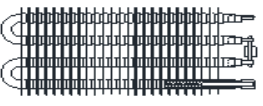
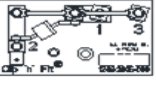

GRILLE		KNOB		ELEMENT		
						
<b>2501-2058-000</b> CWH1101DS CWH1151DS CWH1157DS CWH1201DS CWH1202DS CWH1207DS CWH1208DS CWH1101DSA CWH1151DSA CWH1157DSA CWH1201DSA CWH1202DSA CWH1207DSA CWH1208DSA	<b>1016-11228-000</b> WHB1101FC WHB1151FC WHB1157FC WHB1201FC WHB1202FC WHB1207FC WHB1208FC	<b>3301-2001-000</b> CWH1101DS CWH1151DS CWH1157DS CWH1201DS CWH1202DS CWH1207DS CWH1208DS CWH1101DSA CWH1151DSA CWH1157DSA CWH1201DSA CWH1202DSA CWH1207DSA CWH1208DSA	<b>3301-11015-001</b> WHB1101FC WHB1151FC WHB1157FC WHB1201FC WHB1202FC WHB1207FC WHB1208FC	<b>302023801</b> CWH1101DS CWH1101DSA WHB1101FC <b>302023804</b> CWH1208DS CWH1208DSA WHB1208FC <b>302023808</b> CWH1201DS CWH1201DSA WHB1201FC	<b>302023802</b> CWH1151DS CWH1151DSA WHB1151FC <b>302023805</b> CWH1202DS CWH1202DSA WHB1202FC	<b>302023803</b> CWH1157DS CWH1157DSA WHB1157FC <b>302023806</b> CWH1207DS CWH1207DSA WHB1207FC
<b>LIGHT</b>		<b>MOTOR</b>		<b>DISCONNECT SWITC</b>	<b>FAN BLADE</b>	
						
<b>3510-2008-003</b> CWH1101DS CWH1151DS CWH1157DS CWH1201DS CWH1202DS CWH1207DS CWH1208DS	<b>3510-2008-006</b> CWH1101DSA CWH1151DSA CWH1201DSA WHB1101FC WHB1151FC WHB1201FC	<b>3510-2008-007</b> CWH1157DSA CWH1202DSA CWH1207DSA CWH1208DSA WHB1157FC WHB1202FC WHB1207FC WHB1208FC	<b>490062001</b> CWH1101DS CWH1151DS CWH1201DS CWH1101DSA CWH1151DSA CWH1201DSA WHB1101FC WHB1151FC WHB1201FC <b>490062002</b> CWH1208DS CWH1208DSA CWH1208FC	<b>490062003</b> CWH1202DS CWH1202DSA WHB1202FC <b>490062004</b> CWH1157DS CWH1207DS CWH1157DSA CWH1207DSA WHB1157FC WHB1207FC	<b>410170001</b> ALL MODELS	<b>490061001</b> ALL MODELS  <div style="display: flex; justify-content: space-around;"> <div style="text-align: center;"> <b>CWH</b>   </div> <div style="text-align: center;"> <b>WHB</b>   </div> </div>
<b>THERMOSTAT</b>	<b>THERMAL FUSE</b>	<b>FAN DELAY</b>	<b>HI LIMIT</b>	<b>MANUAL LIMIT</b>		
						
<b>5813-2001-000</b> CWH1101DS CWH1151DS CWH1157DS CWH1202DS CWH1207DS CWH1208DS CWH1101DSA CWH1151DSA CWH1157DSA CWH1202DSA CWH1207DSA CWH1208DSA WHB1101FC WHB1151FC WHB1157FC WHB1202FC WHB1207FC WHB1208FC	<b>5813-2022-000</b> CWH1201DS CWH1201DSA WHB1201FC	<b>4520-2030-000</b> CWH1101DSA CWH1151DSA CWH1157DSA CWH1201DSA CWH1202DSA CWH1207DSA CWH1208DSA WHB1101FC WHB1151FC WHB1157FC WHB1201FC WHB1202FC WHB1207FC WHB1208FC	<b>410074000</b> ALL MODELS	<b>410143000</b> CWH1101DS CWH1151DS CWH1157DS CWH1201DS CWH1202DS CWH1207DS CWH1208DS	<b>4520-11016-000</b> CWH1101DSA CWH1151DSA CWH1157DSA CWH1201DSA CWH1202DSA CWH1207DSA CWH1208DSA WHB1101FC WHB1151FC WHB1157FC WHB1201FC WHB1202FC WHB1207FC WHB1208FC	

**CWH ARCHITECTURAL SERIES (SWH)**



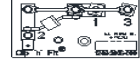

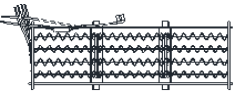
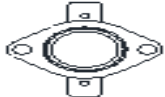
KNOB		GRILLE		ELEMENT		
						
<b>3301-11015-003</b> SWH1012FC SWH1512FC SWH1527FC SWH1812FC SWH2020FC SWH2024FC SWH2027FC	<b>3301-2052-002</b> SWH1012AG SWH1512AG SWH1527AG SWH1812AG SWH2020AG SWH2024AG SWH2027AG SWH1012AGA SWH1512AGA SWH1527AGA SWH1812AGA SWH2020AGA SWH2024AGA SWH2027AGA	<b>1016-11227-000</b> SWH1012FC SWH1512FC SWH1527FC SWH1812FC SWH2020FC SWH2024FC SWH2027FC	<b>2501-2075-000</b> SWH1012AG SWH1512AG SWH1527AG SWH1812AG SWH2020AG SWH2024AG SWH2027AG SWH1012AGA SWH1512AGA SWH1527AGA SWH1812AGA SWH2020AGA SWH2024AGA SWH2027AGA	<b>302023801</b> SWH1012AG SWH1012AGA SWH1012FC <b>302023804</b> SWH2020AG SWH2020AGA SWH2020FC <b>302023808</b> SWH1812AG SWH1812AGA SWH1812FC	<b>302023802</b> SWH1512AG SWH1512AGA SWH1512FC <b>302023805</b> SWH2024AG SWH2024AGA SWH2024FC	<b>302023803</b> SWH1527AG SWH1527AGA SWH1527FC <b>302023806</b> SWH2027AG SWH2027AGA SWH2027FC
<b>LIGHT</b>				<b>MOTOR</b>		<b>DISCONNECT SWITCH</b>
						
<b>3510-2008-002</b> SWH1527AG	<b>3510-2008-003</b> SWH1012AG SWH1512AG SWH1812AG SWH2020AG SWH2024AG SWH2027AG	<b>3510-2017-007</b> SWH1012AGA SWH1512AGA SWH1812AGA SWH1012FC SWH1512FC SWH1812FC	<b>3510-2017-006</b> SWH1527AGA SWH2020AGA SWH2024AGA SWH2027AGA SWH1527FC SWH2020FC SWH2024FC SWH2027FC	<b>490062001</b> SWH1012AG SWH1512AG SWH1812AG SWH1012AGA SWH1512AGA SWH1812AGA SWH1012FC SWH1512FC SWH1812FC <b>490062002</b> SWH2020AG SWH2020AGA SWH2020FC	<b>490062003</b> SWH2024AG SWH2024AGA SWH2024FC <b>490062004</b> SWH1527AG SWH2027AG SWH1527AGA SWH2027AGA SWH1527FC SWH2027FC	<b>410170001</b> ALL MODELS
<b>FAN DELAY</b>	<b>HI LIMIT</b>	<b>MANUAL LIMIT</b>	<b>FAN BLADE</b>	<b>THERMAL FUSE</b>	<b>THERMOSTAT</b>	
						
<b>410074000</b> ALL MODELS	<b>410143000</b> SWH1012AG SWH1512AG SWH1527AG SWH1812AG SWH2020AG SWH2024AG SWH2027AG	<b>4520-11016-000</b> SWH1012AGA SWH1512AGA SWH1527AGA SWH1812AGA SWH2020AGA SWH2024AGA SWH2027AGA SWH1012FC SWH1512FC SWH1527FC SWH1812FC SWH2020FC SWH2024FC SWH2027FC	<b>490061001</b> ALL MODELS	<b>4520-2030-000</b> SWH1012AGA SWH1512AGA SWH1527AGA SWH1812AGA SWH2020AGA SWH2024AGA SWH2027AGA SWH1012FC SWH1512FC SWH1527FC SWH1812FC SWH2020FC SWH2024FC SWH2027FC	<b>5813-2022-000</b> SWH1812AG SWH1812AGA SWH1812FC	<b>5813-2001-000</b> SWH1012AG SWH1512AG SWH1527AG SWH2020AG SWH2024AG SWH2027AG SWH1012AGA SWH1512AGA SWH1527AGA SWH2020AGA SWH2024AGA SWH2027AGA SWH1012FC SWH1512FC SWH1527FC SWH2020FC SWH2024FC SWH2027FC
<div style="display: flex; justify-content: space-around;"> <div style="text-align: center;"> <b>SWH-AG</b>   </div> <div style="text-align: center;"> <b>SWH-FC</b>   </div> </div>						



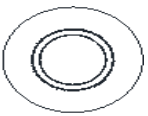

GFR SERIES								
KNOB		GRILLE			LIGHT			
								
<b>3301-2014-004</b> R1500T2 R2004T2 R2404T2 R1500T2A R2004T2A R2404T2A R1500T2B R2004T2B R2404T2B	<b>3301-11015-002</b> R1500T2FC R2004T2FC R2404T2FC	<b>2501-11031-000</b> R1500FC R1500T2FC R2004FC R2004IFFC R2004T2FC R2404FC R2404IFFC R2404T2FC	<b>2501-2026-000</b> R1500 R1500T2 R2004 R2004IF R2004IFB R2404T2 R1500A R1500T2A R2004A R2004IFA R2404T2B		<b>3510-2010-000</b> R1500 R1500T2 R1500A R1500T2A R1500B R1500T2B R1500FC R1500T2FC	<b>3510-2010-001</b> R2004 R2004IF R2004T2 R2004A R2004IFA R2004T2A R2004B R2004IFB R2004T2B R2004FC R2004IFFC R2004T2FC		R2404 R2404IF R2404T2 R2404A R2404IFA R2404T2A R2404B R2404IFB R2404T2B R2404FC R2404IFFC R2404T2FC
<b>BLOWER ASM.</b> 				<b>ELEMENT</b> 			<b>CLIP N FIT BOARD</b> 	
<b>1225-2000-000</b> R1500 R1500T2 R1500A R1500T2A R1500B R1500T2B R1500FC R1500T2FC	<b>1225-2002-001</b> R2404A R2404IFA R2404T2A R2404B R2404IFB R2404T2B R2404FC R2404IFFC R2404T2FC	<b>1225-2000-001</b> R2004 R2004IF R2004T2 R2404 R2404IF R2404T2 R2004A R2004IFA R2004T2A		<b>302023802</b> R1500 R1500T2 R1500A R1500T2A R1500B R1500T2B R1500FC R1500T2FC	<b>302023805</b> R2004 R2004IF R2004T2 R2004A R2004IFA R2004T2A R2004B R2004IFB R2004T2B R2004FC R2004IFFC R2004T2FC	<b>302023809</b> R2404 R2404IF R2404T2 R2404A R2404IFA R2404T2A R2404B R2404IFB R2404T2B R2404FC R2404IFFC R2404T2FC	<b>1249-2005-000</b> ALL MODELS	
<b>THERMOSTAT</b> 	<b>TEMPERATURE REGULATOR</b> 			<b>HI-LIMIT</b> 				
<b>410130001</b> R1500T2 R2004T2 R2404T2 R1500T2A R2004T2A R2404T2A R1500T2B R2004T2B R2404T2B R1500T2FC R2004T2FC R2404T2FC	<b>410143000</b> R1500 R1500T2 R2004 R2004IF R2004T2 R1500A R1500T2A R2004A R2004IFA R2004T2A		<b>4520-2029-000</b> R2404 R2404IF R2404T2 R2404A R2404IFA R2404T2A R2404B R2404IFB R2404T2B R2404FC R2404IFFC R2404T2FC	<b>4520-2025-000</b> R1500 R1500T2 R2004 R2004IF R2004T2 R1500A R1500T2A R2004A R2004IFA R2004T2A	<b>4520-2025-001</b> R2404 R2404IF R2404T2 R2404A R2404IFA R2404T2A	<b>4520-11010-000</b> R1500B R1500T2B R1500FC R1500T2FC	<b>4520-11010-001</b> R2004B R2004IFB R2004T2B R2004FC R2004IFFC R2004T2FC R2404B R2404IFB R2404T2B R2404FC R2404IFFC R2404T2FC	

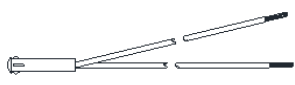
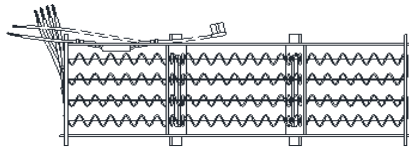
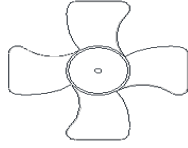
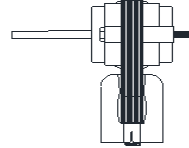

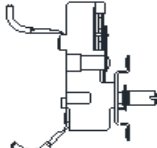
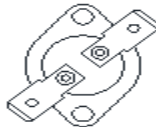



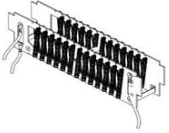
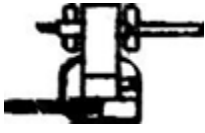
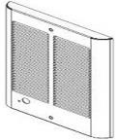

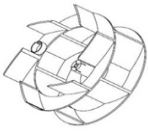

QFG-SERIES									
KNOB	GRILLE	BLOWER ASM				CLIP N FIT BOARD		THERMOSTAT	
									
<b>3301-2040-001</b> G1512T2M G2024T2M G1512T2MA G2024T2MA G2224T2MA G1512T2MB G2024T2MB G2224T2MB G1512T2MC G2024T2MC G2224T2MC	<b>2501-2046-000</b> ALL MODELS	<b>1225-2000-000</b> G1012IF G1512IF G1512M G1512T2M G1512IFMA G1512MA G1512T2MA G1512IFMB G1512MB G1512T2MB G1512IFMC G1512T2MC	<b>1225-2000-001</b> G1024IF G1524IF G2024IF G2024M G2024T2M G2028IF G2224IF G2024IFMA G2024MA G2024T2MA G2028IFA G2224IFMA G2224MA	<b>1225-2002-001</b> G2224T2MA G2024IFMB G2024MB G2024T2MB G2028IFB G2024IFMC G2024T2MC	<b>1225-2002-001</b> G2224IFMB G2224T2MB G2228IFB G2224IFC G2224T2MC G2228IFC	<b>1249-2005-000</b> G1512M G1512T2M G2024M G2024T2M G2224M G1512MA G1512T2MA G2024IFMA G2024MA G2024T2MA G2224IFMA G2224MA G2224T2MA G1512IFMB		G1512MB G1512T2MB G2024IFMB G2024MB G2024T2MB G2224IFMB G2224T2MB G1512IFMC G1512T2MC G2024IFMC G2024T2MC G2224IFC G2224T2MC G2228IFC	<b>410130001</b> G1512T2M G1512T2MA G1512T2MB G2024T2M G2024T2MA G2224T2MA G2024T2MB G2224T2MB G1512T2MC G2024T2MC G2224T2MC
<b>ELEMENT</b>		<b>HI LIMIT</b>				<b>LIGHT</b>			
									
<b>1802-2124-005</b> G1024IF G2024IF	<b>1802-2124-000</b> G1512IF G1512IFMA	<b>4520-11012-000</b> G1512IFMC G1512T2MC	<b>4520-11012-001</b> G2024IFMC G2024T2MC G2224IFC G2224T2MC	<b>4520-2059-000</b> G1012IF G1512IF G1512M G1512T2M G1512IFMA G1512MA G1512T2MA G1512IFMB G1512MB G1512T2MB G1024IF G1524IF G2024M G2024T2M G2228IFB		<b>3510-2017-000</b> G1012IF G1512IF G1512M G1512T2M G1512IFMA G1512MA G1512T2MA G1512IFMB G1512MB G1512T2MB G1512IFMC G1512T2MC	<b>3510-2017-001</b> G1024IF G1524IF G2024IF G2024M G2024T2M G2028IF G2224IF G2224M G2024IFMA G2024MA G2024T2MA G2028IFA G2224IFC G2224MA G2024T2MC G2224T2MC G2228IFC		
<b>1802-2125-000</b> G1512IFMB G1512MB G1512T2MB G1512IFMC G1512T2MC	<b>1802-2125-002</b> G2024IFMB G2024MB G2024T2MB G2024IFMC G2024T2MC	 Patented Clip-N-Fit® feature (US Patented No. 6,172,343)		G2024IFMA G2024MA G2024T2MA G2028IFA G2224IFMA G2224MA G2224T2MA G2024IFMB G2024T2MA G2024IFMC G2024T2MC		G2024IFMB G2024MB G2028IFB G2224IFB G2024IFMC G2024T2MC G2224IFC G2224MA G2224T2MA			
<b>1802-2124-001</b> G2028IFB	<b>1802-2125-001</b> G2224IFMB G2224T2MB			G2024M G2024T2M G2228IFB		G2024MB G2028IFB G2224IFB G2224T2MB		G2024IFMC G2224IFC G2224MA G2224T2MA	
<b>MODELS NOT LISTED ELEMENTS ARE OBSOLETE</b>									



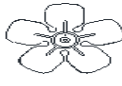

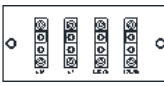
SED SERIES					
KNOB		GRILLE		LIGHT	
					
<b>3301-2044-001</b> D1012C D1024C D1012CA D1024CA	<b>3301-2039-002</b> D1012W D1512 D2024 D1012WA D1024WA D1512A D2024A	<b>2501-2054-001</b> D1012C D1024C D1512CR D1012CA D1024CA D1512CRA	<b>2501-2054-000</b> D1012W D1512 D2024 D1012WA D1024WA D1512A D2024A	<b>3510-2017-002</b> D1012C D1012W D1512 D1512CR D1012CA D1012WA D1512A D1512CRA	<b>3510-2017-003</b> D1024C D2024 D1024CA D1024WA D2024A
ELEMENT			FAN BLADE	MOTOR	
					
<b>1802-2124-003</b> D1012C D1012W D1012CA D1012WA	<b>1802-2124-005</b> D1024C D2024 D1024CA D1024WA D2024A	<b>1802-2124-000</b> D1512 D1512CR D1512A D1512CRA	<b>1210-2008-000</b> ALL MODELS	<b>3900-2037-000</b> D1012C D1012W D1512 D1512CR D1012CA D1012WA D1512A D1512CRA	<b>3900-2037-001</b> D1024C D2024 D1024CA D1024WA D2024A
THERMOSTAT		LIMIT			
					
<b>410130001</b> D1012C D1012W D1512 D1012CA D1012WA D1512A D1024C D2024		<b>4520-2055-000</b> D1012C D1012W D1512 D1512CR D1024C D2024	<b>4520-11009-000</b> D1012CA D1012WA D1512A D1512CRA	<b>4520-11009-001</b> D1024CA D1024WA D2024A	







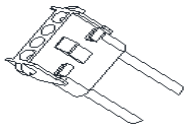
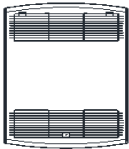
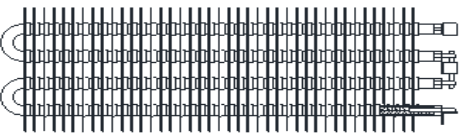
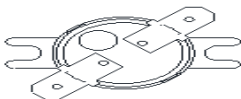



## COZ-E WALL HEATER





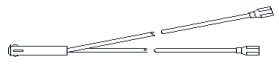
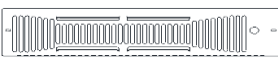
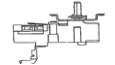

ELEMENT		MOTOR		GRILLE
				
<b>1802-11014-006</b> CZ1012IF	<b>1802-11014-000</b> CZ1512T	<b>3900-11032-000</b> CZ1012IF CZ1012T CZ1512IF CZ1512T	<b>3900-11032-001</b> CZ1048IF CZ1048T CZ1548IF CZ1548T CZ2048IF CZ2048T	<b>2501-11024-000</b> ALL MODELS
<b>1802-11014-001</b> CZ1012T	<b>1802-11014-008</b> CZ1548IF			
<b>1802-11014-009</b> CZ1048IF	<b>1802-11014-003</b> CZ1548T			
<b>1802-11014-004</b> CZ1048T	<b>1802-11014-007</b> CZ2048IF			
<b>1802-11014-005</b> CZ1512IF	<b>1802-11014-002</b> CZ2048T			
THERMOSTAT	FAN IMPELLER	PARTS KIT		
		PICTURE NOT AVAILABLE		
<b>5813-2090-000</b> CZ1012T CZ1048T CZ1512T CZ1548T CZ2048T	<b>2002-11004-000</b> ALL MODELS	<b>1205-11028-501</b> CZ1012IF CZ1048IF CZ1512IF CZ1548IF CZ2048IF	<b>1205-11028-500</b> CZ1012T CZ1048T CZ1512T CZ1548T CZ2048T	



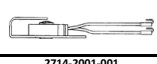

EFQ-SERIES						
GRILLE	ELEMENTS (2 REQ)			MOTOR (2 REQ)		
						
2501-2027-000 ALL MODELS	302012819 Q6003	302012821 Q8003	302012809 Q6004 Q8007	3900-2010-000 Q6003 Q6004 Q60048 Q6006 Q6008 Q8003 Q8004 Q80048 Q8006 Q8008	3900-2010-001 Q6007 Q8007	
	302012820 Q6006 Q8006	302012826 Q80048	302012806 Q6007			
	302012825 Q60048	302012808 Q6008 Q8004	302012807 Q8008			
THERMOSTAT	FAN BLADE (2 REQ)	DISCONNECT SW.	TERMINAL BOARD			
						
410168002 (2REQ.) Q6003 Q60048 Q6006 Q8003 Q80048 Q8006	5813-0023-000 Q6004 Q6007 Q6008 Q8004 Q8007 Q8008	490030103 ALL MODELS	5216-2025-000 ALL MODELS	5823-2002-000 ALL MODELS		
TRANSFORMER			FAN DELAY (2 REQ)	MANUAL LIMIT (2 REQ)		
						
490015017 Q6003 Q8003	490015022 Q60048 Q80048	490015013 Q6006 Q8006	410174000 ALL MODELS	4520-2027-000 ALL MODELS		

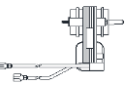









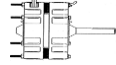

ECP SERIES				
PLUG ASSY FEMALE	GRILLE	ELEMENT		LIMIT
				
<b>1016-0114-000</b> ALL MODELS	<b>2501-2082-000</b> ALL MODELS	<b>302012808</b> ECP1024	<b>302012803</b> ECP1524	<b>4520-2025-001</b> ALL MODELS
				





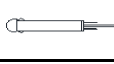





QTS SERIES									
ELEMENTS		MOTOR ASSEMBLY		HI-LIMIT	SELF HOLD LIMIT	FAN DELAY			
									
302023811 S1100 S1100A S1100B S1100C S1100CNW	302023803 S1104 S1104A S1104B S1104C S1104CNW	1225-2002-000 S1100 S1100A S1100B S1100C S1100CNW	1225-2002-001 S1104 S1104A S1104B S1104C S1104CNW	4520-2031-000 S1100 S1100A S1100B S1104 S1104A S1104B S1500 S1500A S1500B S1500C S1500T S1500TA S1500TB S1500TC S1500TCNW	4520-11011-000 S1100C S1100CNW S1500C S1500TC S1500TCNW	1414-2020-000 S1100 S1100A S1104 S1104A S1500 S1500A S1500T S1500TA S1504 S1504A S1504T	410074000 S1100B S1100C S1100CNW S1104B S1104C S1104CNW S1500B S1500C S1500TB S1500TC S1500TCNW S1504B S1504C S1504TB S1504TC S1504TCNW		
302023802 S1500 S1500A S1500B S1500C S1500T S1500TA S1500TB S1500TC S1500TCNW	302023806 S1504 S1504A S1504B S1504C S1504T S1504TA S1504TB S1504TC S1504TCNW	S1500 S1500A S1500B S1500C S1500T S1500TA S1500TB S1500TC S1500TCNW	S1504 S1504A S1504B S1504C S1504T S1504TA S1504TB S1504TC S1504TCNW	S1504 S1504A S1504B S1504C S1504T S1504TA S1504TB S1504TC S1504TCNW	4520-11011-001 S1104C S1104CNW S1504C S1504TC S1504TCNW	S1500A S1500T S1500TA S1504 S1504A S1504T	S1500B S1500C S1500TB S1500TC S1500TCNW S1504B S1504C S1504TB S1504TC S1504TCNW		
PILOT LIGHT		GRILLE		THERMOSTAT		KNOB		THERMAL CUTOFF	
									
3510-2010-000 S1100A S1100B S1100C S1100CNW S1500A S1500B S1500C S1500TA S1500TB S1500TC S1500TCNW	3510-2010-001 S1104 S1104A S1104B S1104C S1104CNW S1504 S1504A S1504B S1504C S1504T S1504TA S1504TB S1504TC S1504TCNW	2501-2039-000 S1100 S1100A S1100B S1100C S1104 S1104A S1104B S1104C S1500 S1500A S1500B S1500C S1500TA S1500TB		S1500TC S1504 S1504A S1504B S1504C S1504T S1504TA S1504TB S1504TC	2501-2039-001 S1100CNW S1104CNW S1500TCNW S1504TCNW	410129001 S1500T S1500TA S1500TB S1500TC S1500TCNW S1504T S1504TA S1504TB S1504TC S1504TCNW	3301-2020-006 S1500T S1500TA S1500TB S1500TC S1500TCNW S1504T S1504TA S1504TB S1504TC S1504TCNW	4520-2030-000 ALL MODELS 	









FDI SERIES				
BLADE	ELEMENT		GRILLE	BUZZER
				
1210-0046-000 I1500 I1504	1802-5032-000 I1500	1802-5032-004 I1504	2501-5016-001 I1500 I1504	2714-2001-001 I1500 I1504
MOTOR		ONE SHOT FUSE BLUE DOT	HI LIMIT WHITE DOT	
				
3900-2025-000 I1500	3900-2025-001 I1504	4520-2041-000 I1500 I1504	4520-5015-001 I1500 I1504	

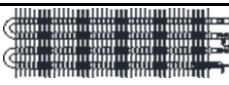

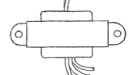





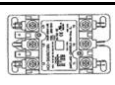

WHT SERIES PUMP HOUSE HEATER			
ELEMENT	KNOB	THERMOSTAT	
			
1802-2091-000	3301-2020-006	5813-2062-000	

CFWF					
TOP FRONT PANEL	BOTTOM FRONT PANEL	TOP TRIM PANEL	MOTOR	RELAY	TRANSFORMER
					
1402-2312-000 CFWF920 CFWF920A	1402-2313-000 CFWF920 CFWF920A	5806-2004-000 CFWF920 CFWF920A	3900-2036-000 CFWF920 CFWF920A	5018-2017-001 CFWF920 CFWF920A	5814-0003-000 CFWF920 CFWF920A
HI-LIMIT	MANUAL RESET LIMIT	ELEMENT	FAN BLADE	PILOT LIGHT	CERAMIC LIMITS
					
4520-2053-000 CFWF920	4520-2027-000 CFWF920A	1802-2117-101 CFWF920 CFWF920A	1210-2009-001 CFWF920 CFWF920A	3510-2018-000 CFWF920 CFWF920A	4520-2052-000 CFWF920 CFWF920A



QCH (U SERIES)						
GRILLE		PLASTIC COVER (2 REQ)	ELEMENTS		MOTOR	
						
1402-2121-000 U1000 U1000A U1500 U1500A U1507 U1800 U2004 U2004A U2007 U2007A U2008	1016-11228-001 U1000FA U1500FA U2004FA U2007FA	1402-2119-000 U1000 U1000A U1500 U1500A U1507 U1800 U2004 U2004A U2007 U2007A U2008	302023801 U1000 U1000A U1000FA	302023803 U1507 302023808 U1800	490062001 U1000 U1000A U1000FA U1500 U1500A U1800	490062003 U2004 U2004A U2004FA 490062004 U2007 U2007A U2007FA 490062002 U2008
LIGHT		FAND DELAY	HI-LIMIT	FAND BLADE	DISCONNECT SW	
						
3510-2008-003 U1000A U1000FA U1500A U1500FA	3510-2008-002 U2004A U2004FA U2007A U2007FA	410074000 ALL MODELS	410143000 ALL MODELS	490061001 ALL MODELS	410170001 ALL MODELS	

EFF (F SERIES)						
MOTOR	ELEMENT			DISCONNECT		
						
3900-2002-520 F1500	3900-2002-500 F2004 F2008 F3003 F3006 F4003 F4004 F4006 F4008	302012827 F1500 302015806 F1507 302015802 F2004 302015803 F2007 302015801 F2008 302012819 F3003	302012821 F4003 302012808 F4004 302012822 F4006 302012809 F4007 302012807 F4008 302012823 F4803	302012811 F4807 1802-2075-802 F40043 1802-2075-800 F40083 1802-2075-803 F48043 1802-2075-801 F4808 F48083 1802-2075-004 F48483 F48483LV	410170001 F1500 F1507 F2004 F2007 F2008 F3007 F4004 F4007 F4008 F4804 F4807	5216-2019-000 F3003 F3006 F4003 F40043 F4006 F40083 F4803 F48043 F4806 F4808 F48083 F48483 F48483LV
POWER TR.	SECONDARY TR.	RELAY	GRILLE	HI-LIMIT	FAN DELAY	FAN BLADE
						
490015017 F3003 F4003 F4803	490065002 F48483LV	5018-2017-000 F40043 F48043 F48483 5018-2017-004 F40083 F4808 F48083 5018-2017-001 F48483LV	1402-2139-001 ALL MODELS	410169001 ALL MODELS	410074000 ALL MODELS	490030103 ALL MODELS
490015013 F3006 F4006 F4806						
490015022 F48483 F48483LV						

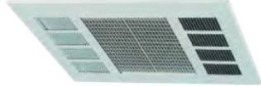
CDF (500 SERIES)				
ELEMENT	MOTOR	RELAY	OUTLET GRILLE	LOUVER GUIDES
				
302012802 542	302012813 552	3900-2011-000 542	2501-2020-001 ALL MODELS	1215-2059-000 REA (2 REQ'D) 1215-2059-001 SEA (2 REQ'D)
302012803 547	302012814 557	5018-0004-102 548 552 558		
302012801 548	302012812 558	3900-2011-001 547 557		
FAN DELAY	FAN BLADE	HI-LIMIT	POWER BLOCK	
				 
1414-2039-000 ALL MODELS	1210-2000-000 ALL MODELS	4520-0011-000 ALL MODELS	5823-0004-000 ALL MODELS	

**CJ900 SERIES**















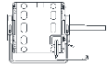
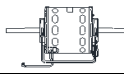









**ELEMENTS**





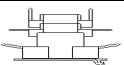
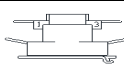
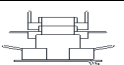
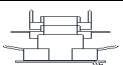
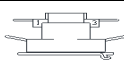
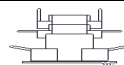

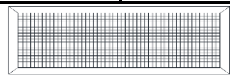
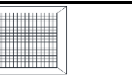

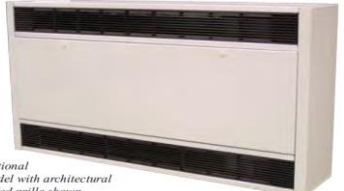

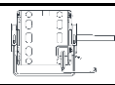
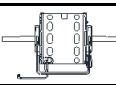
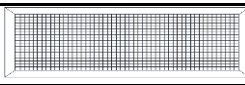
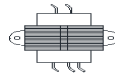

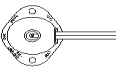



MODEL	NO. REQ.	208V	NO. REQ.	240V	NO. REQ.	277V	NO. REQ.	347V	NO. REQ.	380V	NO. REQ.	480V	NO. REQ.	600V
<b>935</b>														
2KW	1	1802-2083-100	1	1802-2083-101	1	1802-2083-114	1	1802-2083-103	1	1802-2083-101	1	1802-2083-114	1	1802-2083-103
3KW	1	1802-2083-107	1	1802-2083-108	1	1802-2083-116	1	1802-2083-105	1	1802-2083-108	1	1802-2083-116	1	1802-2083-105
4KW	1	1802-2083-106	1	1802-2083-107	1	1802-2083-108	1	1802-2083-109	1	1802-2083-107	1	1802-2083-108	1	1802-2083-109
5KW	1	1802-2083-110	1	1802-2083-111	1	1802-2083-120	1	1802-2083-113	1	1802-2083-111	1	1802-2083-120	1	1802-2083-113
6KW	2	1802-2083-107	2	1802-2083-108	2	1802-2083-116	2	1802-2083-105	2	1802-2083-108	2	1802-2083-116	2	1802-2083-113
7KW	1	1802-2083-106	1	1802-2083-107	1	1802-2083-116	1	1802-2083-105	1	1802-2083-107	1	1802-2083-116	1	1802-2083-105
	1	1802-2083-107	1	1802-2083-108	1	1802-2083-108	1	1802-2083-109	1	1802-2083-108	1	1802-2083-108	1	1802-2083-109
8KW	1	1802-2083-107	1	1802-2083-108	1	1802-2083-116	1	1802-2083-105	1	1802-2083-108	1	1802-2083-116	1	1802-2083-105
	1	1802-2083-110	1	1802-2083-111	1	1802-2083-120	1	1802-2083-113	1	1802-2083-111	1	1802-2083-114	1	1802-2083-113
<b>945</b>														
4KW	2	1802-2083-100	2	1802-2083-101	2	1802-2083-114	2	1802-2083-103	2	1802-2083-101	2	1802-2083-114	2	1802-2083-103
6KW	2	1802-2083-107	2	1802-2083-108	2	1802-2083-116	2	1802-2083-105	2	1802-2083-108	2	1802-2083-116	2	1802-2083-105
8KW	2	1802-2083-106	2	1802-2083-107	2	1802-2083-108	2	1802-2083-109	2	1802-2083-107	2	1802-2083-108	2	1802-2083-109
10KW	2	1802-2083-110	2	1802-2083-111	2	1802-2083-120	2	1802-2083-113	2	1802-2083-111	2	1802-2083-120	2	1802-2083-113
12KW	4	1802-2083-107	4	1802-2083-108	4	1802-2083-116	4	1802-2083-105	4	1802-2083-108	4	1802-2083-116	4	1802-2083-113
14KW	2	1802-2083-106	2	1802-2083-107	2	1802-2083-116	2	1802-2083-105	2	1802-2083-107	2	1802-2083-116	2	1802-2083-105
	2	1802-2083-107	2	1802-2083-108	2	1802-2083-108	2	1802-2083-109	2	1802-2083-108	2	1802-2083-108	2	1802-2083-109
16KW	2	1802-2083-107	2	1802-2083-108	2	1802-2083-116	2	1802-2083-105	2	1802-2083-108	2	1802-2083-116	2	1802-2083-105
	2	1802-2083-110	2	1802-2083-111	2	1802-2083-120	2	1802-2083-113	2	1802-2083-111	2	1802-2083-114	2	1802-2083-113

**58" AND LARGER HEATERS CONTACT FACTORY**

**LOUVERED PANELS**

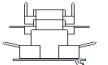
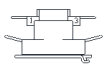
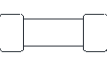





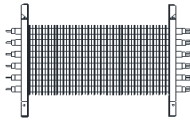
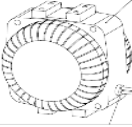

<b>DESERT TAN</b>	35"	4513-2114-T35	<b>NAVAJO WHITE</b>	35"	4513-2114-P35	<b>NORTHERN WHITE</b>	35"	4513-2114-W35	<b>STAT BRONZE</b>	35"	4513-2114-S35
	45"	4513-2114-T45		45"	4513-2114-P45		45"	4513-2114-W45		45"	4513-2114-S45
	58"	4513-2114-T58		58"	4513-2114-P58		58"	4513-2114-W58		58"	4513-2114-S58
	78"	4513-2114-T78		78"	4513-2114-P78		78"	4513-2114-W78		78"	4513-2114-S78
<b>ALUMINUM</b>	35"	4513-2114-A35	<b>BLACK</b>	35"	4513-2114-B35	<b>CHARCOL GREY</b>	35"	4513-2114-G35	<b>NEUTRAL GREY</b>	35"	4513-2114-N35
	45"	4513-2114-A45		45"	4513-2114-B45		45"	4513-2114-G45		45"	4513-2114-N45
	58"	4513-2114-A58		58"	4513-2114-B58		58"	4513-2114-G58		58"	4513-2114-N58
				78"	4513-2114-B78				78"	4513-2114-N78	

CU900 CONTINUED						
PRIMARY TRANSFORMER			SEC. TRANSFORMER	MOTORS		BLOWER WHEEL
 POWER TR 490015007 490015020 490015023 490015025 490015026			 490026910 MODELS WITH 24V CONTR.	 3900-2032-000 CU935 CU968**	 3900-2033-000 ALL MODELS CU945 CU958 CU968** CU978*	 490047001 ALL MODELS
277V 347V 400/380V 480/277V 600/347V			240V 240V 220/208V 240V 240V			
DAMPER MOTOR	DAMPER RHEOSTAT	DAMPER RHEOSTAT KNOB	THERMOSTAT SPST	THERMOSTAT 2STG	THERMOSTAT KNOB	PLUG BUTTON
 490050001 MODELS WITH AIR DAMPER	 410104001 MODELS WITH AIR DAMPER	 482084001 MODELS WITH AIR DAMPER	 410127001 SINGLE STAGE MODELS	 5813-2008-000 TWO STAGE MODELS	 3301-2020-001 ALL MODELS	 4506-2012-000 ALL MODELS
DAMPER ROCKER SW	FAN AUTO/ON SW	ON/OFF SW	HIGH/LOW SW	DOOR SAFETY SW	AUTO HIGH LIMIT	MANUAL LIMIT
 410131001 MODELS WITH AIR DAMPER	 5216-2029-001 ALL MODELS	 5216-2029-001 ALL MODELS	 5216-2029-000 SINGLE STAGE MODELS	 5216-2028-000 ALL MODELS	 4520-2048-000 ALL MODELS	 4520-2017-000 ALL MODELS
FAN AUTO RELAY (120V)	FAN DELAY RELAY(120V)	POWER RELAY (120)	FAN AUTO RELAY (24V)	FAN DELAY RELAY (24V)	POWER RELAY (24)	NIGHT SETBACK RELAY
 410101003 MODELS WITH 120V CONTROL	 410171002 MODELS WITH 120V CONTROL	 410101003 MODELS WITH 120V CONTROL	 410101001 MODELS WITH 24V CONTROL	 410171001 MODELS WITH 24V CONTROL	 410101001 MODELS WITH 24V CONTROL	 410101001 MODELS WITH 24V CONTROL
FUSE	FILTER	FILTER REUSABLE	DISCONNECT SW			
 481001017 ALL MODELS	 2010-7008-006 CU935 2010-7008-007 CU945 2010-7008-008 CU958 2010-7008-009 CU968 2010-7008-010 CU978	 2010-7009-006 CU935 2010-7009-007 CU945 2010-7009-008 CU958 2010-7009-009 CU968 2010-7009-010 CU978	 30 AMP 60 AMP 100 AMP			
NOTES: * TAKES TWO MOTORS ** TAKES ONE OF EACH TYPE MOTOR						 <i>Optional model with architectural styled grille shown</i>

CU 900 SERIES STOCK MODELS						
ELEMENT		MOTOR		FILTER		
 1802-2083-110 S93505203FFB S94510203FFB 1802-2083-111 S93505243FFB S94510243FFB		 3900-2032-000 S93505203FFB S93505243FFB S93505483FFB S93505603FFB		 3900-2033-000 S94510203FFB S94510243FFB S94510483FFB S94510603FFB		 2010-7008-006 S93505203FFB S93505243FFB S93505483FFB S93505603FFB
S94510483FFB S94510603FFB		S94510483FFB S93505603FFB				
PRI. TRANSFORMER	SEC. TR (240/24V)	MANUAL RESET	LIMIT	HIGH/LOW SW.		
 490015025 S93505483FFB S94510483FFB	 490015026 S93505603FFB S94510603FFB	 490026910 ALL MODELS	 4520-2017-000 ALL MODELS	 4520-2048-000 ALL MODELS	 5216-2029-000 ALL MODELS	
PLUG BUTTON	T'STAT KNOB	THERMOSTAT	BLOWER WHEEL	DOOR SW.	FAN AUTO/ON SW.	
 4506-2012-000 ALL MODELS	 3301-2020-001 ALL MODELS	 410127001 ALL MODELS	 490047001 ALL MODELS	 5216-2028-000 ALL MODELS	 5216-2029-001 ALL MODELS	
TIME DELAY RELAY	FAN DELAY RELAY	FUSE	CAPACITOR			
 410101001 ALL MODELS	 410171001 ALL MODELS	 481001017 ALL MODELS	 1432-0002-003 S93505203FFB S93505243FFB S93505483FFB S93505603FFB S94510243FFB S94510483FFB S94510603FFB			
			 1432-0002-001 S94510203FFB			
 <i>Optional model with architectural styled grille shown</i>						



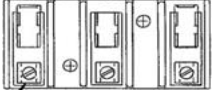



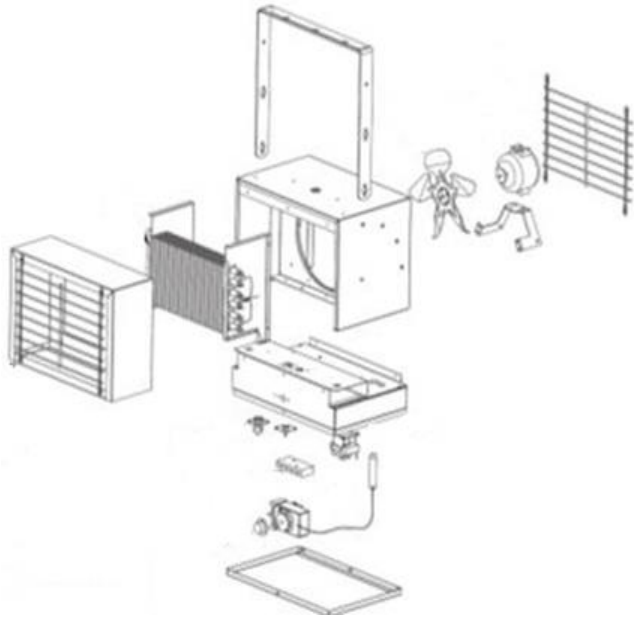





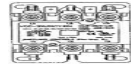





**COMPACT FREEZE PROTECTION HEATERS PHFP25**





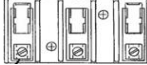







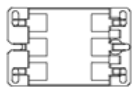
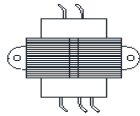
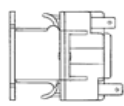

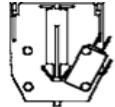

ELEMENT	MOTOR	FAN BLADE	FAN RELAY	RELAY
				
<p align="center"><b>1802-11002-000</b> CHPR25</p>	<p align="center"><b>3900-11007-000</b> CHPR25</p>	<p align="center"><b>1210-2017-000</b> CHPR25</p>	<p align="center"><b>410171003</b> CHPR25</p>	<p align="center"><b>1414-2038-000</b> CHPR25</p>
THERMOSTAT	KNOB	HI LIMIT	POWER BLOCK	MT. BRACKET
				
<p align="center"><b>5813-2091-000</b> CHPR25</p>	<p align="center"><b>3301-2053-000</b> CHPR25</p>	<p align="center"><b>1414-2037-000</b> CHPR25</p>	<p align="center"><b>5823-0004-005</b> CHPR25</p>	<p align="center"><b>310876001</b> CHPR25</p>

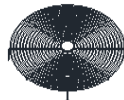
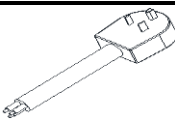

IUH SERIES

ELEMENT			FAN BLADE		MOTOR		RELAY			
										
302006804 UH520 UH520A	302006811 UH727 UH727A	302006842 UH1534 UH1560	1210-2017-000 UH520 UH520A UH524 UH524A	490011001 UH1020 UH1024 UH1027 UH1034 UH1048 UH1060 UH1520 UH1524 UH1527 UH1534 UH1548 UH1560A UH720 UH720A UH724 UH724A UH727 UH727A UH734 UH734A UH748 UH748A UH760 UH760A	3900-2008-000 UH520 UH520A UH524 UH524A UH534 UH534A UH538 UH538A UH548 UH548A UH560 UH560A UH720 UH720A UH724 UH724A	490059004 UH1020 UH1024 UH1027 UH1034 UH1048 UH1060 UH1520 UH1524 UH1527 UH1534 UH1548 UH1560 UH720 UH2034 UH2048 UH2060 UH724A	5018-0004-102 UH520A UH524A UH538 UH538A UH548 UH548A UH560 UH560A UH720 UH724 UH748 UH748A UH760 UH760A UH1034	5018-0003-002 UH534 UH534A UH734 UH734A UH1534	5018-0005-006 UH1020 UH1024 UH1027 UH1048 UH1060 UH1520 UH1524 UH1527 UH1548 UH1560 UH2034 UH2048 UH2060 UH2548 UH2560 UH3048 UH3060	
302006807 UH524 UH524A UH548 UH548A	302006840 UH734 UH734A UH760 UH760A	302006829 UH2548 302006843 UH2560 302006822 UH3048 302006844 UH3060	UH534 UH534A UH538 UH538A UH548 UH548A UH560 UH560A UH720 UH720A UH724 UH724A UH727 UH727A UH734 UH734A UH748 UH748A UH760 UH760A	UH1020 UH1024 UH1027 UH1034 UH1048 UH1060 UH1520 UH1524 UH1527 UH1534 UH1548 UH1560 UH720 UH2034 UH2048 UH2060 UH724A UH727 UH727A UH734 UH734A UH748 UH748A UH760 UH760A	UH520 UH520A UH524 UH524A UH534 UH534A UH538 UH538A UH548 UH548A UH560 UH560A UH720 UH720A UH724 UH724A	UH1020 UH1024 UH1027 UH1034 UH1048 UH1060 UH1520 UH1524 UH1527 UH1534 UH1548 UH1560 UH720 UH2034 UH2048 UH2060 UH724A UH2548 UH2560 UH3048 UH3060	UH520A UH524A UH538 UH538A UH548 UH548A UH560 UH560A UH720 UH724 UH748 UH748A UH760 UH760A UH1034	UH534 UH534A UH734 UH734A UH1534	UH1020 UH1024 UH1027 UH1048 UH1060 UH1520 UH1524 UH1527 UH1548 UH1560 UH2034 UH2048 UH2060 UH2548 UH2560 UH3048 UH3060	
302006839 UH534 UH534A UH560 UH560A	302006812 UH1020 UH1527 302006813 UH1024 UH1048 UH1520 UH2048	UH1020 UH1524 UH1527 UH1534 UH1548 UH1560 UH720 UH720A UH724 UH724A UH727 UH727A UH734 UH734A UH748 UH748A UH760 UH760A	UH538 UH538A UH548 UH548A UH560 UH560A UH720 UH720A UH724 UH724A UH727 UH727A UH734 UH734A UH748 UH748A UH760 UH760A	UH1020 UH1024 UH1027 UH1034 UH1048 UH1060 UH1520 UH1524 UH1527 UH1534 UH1548 UH1560 UH720 UH2034 UH2048 UH2060 UH724A UH727 UH727A UH734 UH734A UH748 UH748A UH760 UH760A	UH520 UH520A UH524 UH524A UH534 UH534A UH538 UH538A UH548 UH548A UH560 UH560A UH720 UH720A UH724 UH724A	UH1020 UH1024 UH1027 UH1034 UH1048 UH1060 UH1520 UH1524 UH1527 UH1534 UH1548 UH1560 UH720 UH2034 UH2048 UH2060 UH724A UH2548 UH2560 UH3048 UH3060	UH520A UH524A UH538 UH538A UH548 UH548A UH560 UH560A UH720 UH724 UH748 UH748A UH760 UH760A UH1034	UH534 UH534A UH734 UH734A UH1534	UH1020 UH1024 UH1027 UH1048 UH1060 UH1520 UH1524 UH1527 UH1548 UH1560 UH2034 UH2048 UH2060 UH2548 UH2560 UH3048 UH3060	
302006848 UH538 UH538A	UH1024 UH1048 UH1520 UH2048	UH1020 UH1524 UH1527 UH1534 UH1548 UH1560 UH720 UH720A UH724 UH724A UH727 UH727A UH734 UH734A UH748 UH748A UH760 UH760A	UH538 UH538A UH548 UH548A UH560 UH560A UH720 UH720A UH724 UH724A UH727 UH727A UH734 UH734A UH748 UH748A UH760 UH760A	UH1020 UH1024 UH1027 UH1034 UH1048 UH1060 UH1520 UH1524 UH1527 UH1534 UH1548 UH1560 UH720 UH2034 UH2048 UH2060 UH724A UH727 UH727A UH734 UH734A UH748 UH748A UH760 UH760A	UH520 UH520A UH524 UH524A UH534 UH534A UH538 UH538A UH548 UH548A UH560 UH560A UH720 UH720A UH724 UH724A	UH1020 UH1024 UH1027 UH1034 UH1048 UH1060 UH1520 UH1524 UH1527 UH1534 UH1548 UH1560 UH720 UH2034 UH2048 UH2060 UH724A UH2548 UH2560 UH3048 UH3060	UH520A UH524A UH538 UH538A UH548 UH548A UH560 UH560A UH720 UH724 UH748 UH748A UH760 UH760A UH1034	UH534 UH534A UH734 UH734A UH1534	UH1020 UH1024 UH1027 UH1048 UH1060 UH1520 UH1524 UH1527 UH1548 UH1560 UH2034 UH2048 UH2060 UH2548 UH2560 UH3048 UH3060	
302006809 UH720 UH720A	302006814 UH1027 UH1524 UH1548	UH1020 UH1524 UH1527 UH1534 UH1548 UH1560 UH720 UH720A UH724 UH724A UH727 UH727A UH734 UH734A UH748 UH748A UH760 UH760A	UH538 UH538A UH548 UH548A UH560 UH560A UH720 UH720A UH724 UH724A UH727 UH727A UH734 UH734A UH748 UH748A UH760 UH760A	UH1020 UH1024 UH1027 UH1034 UH1048 UH1060 UH1520 UH1524 UH1527 UH1534 UH1548 UH1560 UH720 UH2034 UH2048 UH2060 UH724A UH727 UH727A UH734 UH734A UH748 UH748A UH760 UH760A	UH520 UH520A UH524 UH524A UH534 UH534A UH538 UH538A UH548 UH548A UH560 UH560A UH720 UH720A UH724 UH724A	UH1020 UH1024 UH1027 UH1034 UH1048 UH1060 UH1520 UH1524 UH1527 UH1534 UH1548 UH1560 UH720 UH2034 UH2048 UH2060 UH724A UH2548 UH2560 UH3048 UH3060	UH520A UH524A UH538 UH538A UH548 UH548A UH560 UH560A UH720 UH724 UH748 UH748A UH760 UH760A UH1034	UH534 UH534A UH734 UH734A UH1534	UH1020 UH1024 UH1027 UH1048 UH1060 UH1520 UH1524 UH1527 UH1548 UH1560 UH2034 UH2048 UH2060 UH2548 UH2560 UH3048 UH3060	
302006810 UH724 UH724A UH748 UH748A	302006841 UH1034 UH1060 UH2034 UH2060	UH1020 UH1524 UH1527 UH1534 UH1548 UH1560 UH720 UH720A UH724 UH724A UH727 UH727A UH734 UH734A UH748 UH748A UH760 UH760A	UH538 UH538A UH548 UH548A UH560 UH560A UH720 UH720A UH724 UH724A UH727 UH727A UH734 UH734A UH748 UH748A UH760 UH760A	UH1020 UH1024 UH1027 UH1034 UH1048 UH1060 UH1520 UH1524 UH1527 UH1534 UH1548 UH1560 UH720 UH2034 UH2048 UH2060 UH724A UH727 UH727A UH734 UH734A UH748 UH748A UH760 UH760A	UH520 UH520A UH524 UH524A UH534 UH534A UH538 UH538A UH548 UH548A UH560 UH560A UH720 UH720A UH724 UH724A	UH1020 UH1024 UH1027 UH1034 UH1048 UH1060 UH1520 UH1524 UH1527 UH1534 UH1548 UH1560 UH720 UH2034 UH2048 UH2060 UH724A UH2548 UH2560 UH3048 UH3060	UH520A UH524A UH538 UH538A UH548 UH548A UH560 UH560A UH720 UH724 UH748 UH748A UH760 UH760A UH1034	UH534 UH534A UH734 UH734A UH1534	UH1020 UH1024 UH1027 UH1048 UH1060 UH1520 UH1524 UH1527 UH1548 UH1560 UH2034 UH2048 UH2060 UH2548 UH2560 UH3048 UH3060	
LIGHT	FUSE BLOCK	FUSE	CAPACITOR	HI LIMIT	FAN DELAY	TRANSFORMER				
										
3510-2017-003 UH524A UH724A	480099002 UH1020 UH1024 UH1520 480099003 UH1520 UH1524 480096000 UH1527 480099001 UH1534 UH2034 2025-0001-000 UH2034	481001003 UH1020 UH1024 UH1520 UH1534 UH2034 481001006 UH1520 UH1524 481001023 UH1527 2019-7002-007 UH2034	1432-0002-003 UH2548 UH2560 UH3048 UH3060	410027000 ALL MODELS	410148000 ALL MODELS	490015017 UH534 UH534A UH734 UH734A 490015014 UH538 UH538A 490056001 UH548 UH548A UH748 UH748A	490015013 UH560 UH560A UH760 UH760A 490015009 UH1027 UH1527 490015019 UH1034 UH1534 UH2034	490015010 UH1048 UH1548 UH2048 490015012 UH1060 UH1560 UH2060 490015008 UH2548 UH3048 490015015 UH2560 UH3060		
QUANTITY 5 & 7.5KW (4) 10 THRU 20KW (6) 25 & 30KW (9)	LOUVER 		LOUVER SPRING 	HOLE PLUG 	MT. BRACKET 	POWER BLOCK 				
3503-2004-010 UH520 UH520A UH524 UH524A UH534 UH534A UH538 UH538A UH548 UH548A UH560 UH560A UH720 UH720A UH724 UH724A UH727 UH727A UH734 UH734A UH748 UH748A UH760 UH760A	3503-2004-011 UH1020 UH1024 UH1027 UH1034 UH1048 UH1060 UH1520 UH1524 UH1527 UH1534 UH1548 UH1560 UH2034 UH2048 UH2060	3503-2004-012 UH2548 UH2560 UH3048 UH3060	5208-7005-001 ALL MODELS	29214-11621 UH520 UH520A UH524 UH524A UH534 UH534A UH538 UH538A UH548 UH548A UH560 UH560A UH720 UH720A UH724 UH724A UH727 UH727A UH734 UH734A UH748 UH748A UH760 UH760A	310876001 UH520 UH520A UH524 UH524A UH534 UH534A UH538 UH538A UH548 UH548A UH560 UH560A UH720 UH720A UH724 UH724A UH727 UH727A UH734 UH734A UH748 UH748A UH760 UH760A	5823-0004-000 UH520 UH520A UH524 UH524A UH534 UH534A UH538 UH538A UH548 UH548A UH560 UH560A UH720 UH720A UH724 UH724A UH727 UH727A UH734 UH734A UH748 UH748A UH760 UH760A 5823-0004-005 UH734 UH734A	480100001 UH1020 UH1024 UH1027 UH1034 UH1048 UH1060 UH1520 UH1524 UH1527 UH1534 UH1548 UH1560 UH2034 UH2048 UH2060 480034002 UH2548 UH2560 UH3048 UH3060			

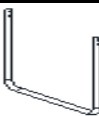
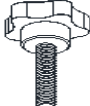
### MEDH SERIES

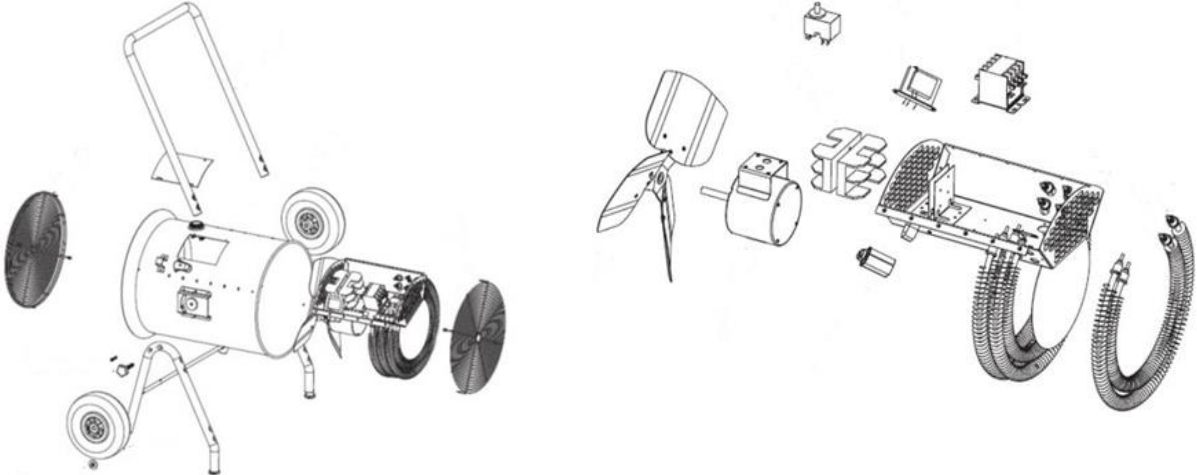
ELEMENT SMALL	ELEMENT LARGE	MOTOR	CONTACTOR	TRANSFORMER	FAN RELAY
					
<b>1802-11001-000</b> DH1583A DH1583B	<b>1802-11001-001</b> DH1583A DH1583B	<b>3900-11002-000</b> DH1021A DH1021CKA DH1021CKB DH1521A DH1521B DH1523A DH1523B DH1583A DH1583B	<b>5018-0006-000</b> DH1543A DH1543B DH3043A DH3043B	<b>5814-0003-002</b> DH1543A DH1543B DH3043A DH3043B	<b>5018-0007-000</b> DH1543A DH1543B DH3043A DH3043B
<b>1802-11001-002</b> DH1021A DH1021CKA DH1021CKB DH1521A DH1521B DH1523A DH1523B DH1543A DH1543B DH3043A DH3043B	<b>1802-11001-003</b> DH1021A DH1021CKA DH1021CKB DH1521A DH1521B DH1523A DH1523B DH1543A DH1543B DH3043A DH3043B	<b>3900-11002-001</b> DH1543A DH1543B DH3043A DH3043B	<b>5018-0006-002</b> DH1021A DH1021CKA DH1021CKB DH1523A DH1523B DH1583A DH1583B		
			<b>5018-0006-004</b> DH1521A DH1521B		
FAN BLADE	AUXILIARY SWITCH	THERMOSTAT	CAPACITOR	GUARD REAR	GUARD FRONT
					
<b>1210-0098-001</b> ALL MODELS	<b>5216-10564-000</b> ALL MODELS	<b>5813-2059-000</b> ALL MODELS	<b>1432-0002-003</b> ALL MODELS	<b>2504-11004-000</b> ALL MODELS	<b>2504-11005-000</b> ALL MODELS
CORD	FUSE	FUSE BLOCK	HI LIMIT	SHAFT CAP	WHEEL
					
<b>1016-10593-000</b> DH1021CKA DH1021CKB	<b>2019-7008-077</b> DH1521A DH1521B	<b>480030007</b> DH1521A DH1521B	<b>410029000</b> ALL MODELS	<b>1408-11002-000</b> ALL MODELS	<b>6406-11001-000</b> ALL MODELS
HANDLE	CART KNOB	THERMOSTAT KNOB			
					
<b>2710-11001-000</b> ALL MODELS	<b>3301-11003-000</b> ALL MODELS	<b>3301-11018-002</b> ALL MODELS			
					

MSDH

MODEL	ELEMENT (11)	ELEMENT (12)	MOTOR (16)	CONTACTOR (20)
SDH3043	118-304793-011 (3)	118-304793-013 (3)	193-121843-232	072-304551-008
SDH3093	118-304793-012 (3)	118-304793-014 (3)	193-121843-233	072-304551-008
SDH4843	118-304793-011 (3)	118-304793-013 (6)	193-121843-232	072-304551-008 (2)
SDH4893	118-304793-012 (3)	118-304793-014 (6)	193-121843-233	072-304551-008 (2)
SDH6043	118-304793-011 (6)	118-304793-013 (6)	193-121843-232	072-304551-008 (2)
SDH6093	118-304793-012 (6)	118-304793-014 (6)	193-121843-233	072-304551-008 (2)
MODEL	TRANSFORMER (21)	FUSE BLOCK (80)	FUSE (81)	TERM. BLOCK (84)
SDH3043	315-304252-001	NA	NA	NA*
SDH3093	315-304252-003	NA	NA	NA*
SDH4843	315-304252-001	129-025643-001	128-026510-005 (3)	303-047468-004
SDH4893	315-304252-003	129-025643-001	128-026510-005 (3)	303-047468-004
SDH6043	315-304252-001	129-025643-001 (2)	128-026510-006 (6)	303-047468-004
SDH6093	315-304252-003	129-025643-001 (2)	128-026510-006 (6)	303-047468-004

PARTS COMMON TO ALL UNITS

TEMPERATURE CONTROL (18)	300-019560-002
HI-LIMIT (19)	300-049200-004
TOGGLE SWITCH (23)	292-046123-001
BLOWER ASSEMBLY (32)	021-304823-009
INLET & OUTLET GRILLE (33)	134-304780-002 (2)
CASTER/LOCKING (36)	375-122535-007
HANDLE-RIGHT SIDE (37)	139-304779-003
HANDLE-LEFT SIDE (38)	139-304479-004
SEMPNEUMATIC WHEEL (45)	333-557518-004 (2)
PULLEY VAR. PITCH 7/8" (77)	225-305091-004
PULLEY VAR. PITCH 5/8" (78)	225-305091-003
PULLEY BELT (79)	017-049702-009
PILOT LIGHT-GREEN (86)	213-122066-043
PILOT LIGHT-AMBER (87)	213-122066-042
THERMOSTAT KNOB (94)	169-017949-004

NOTES:

(#) QUANTITY REQ.

\* WIRED DIRECTLY TO CONTACTOR

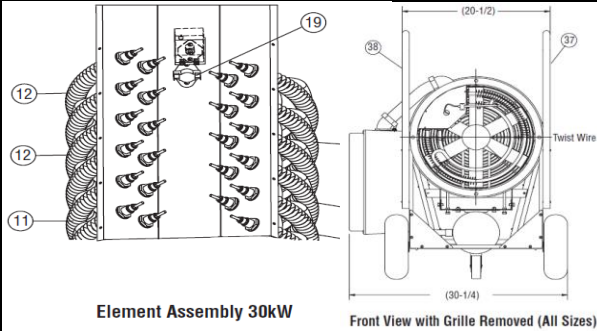

Element Assembly 30kW

Front View with Grille Removed (All Sizes)

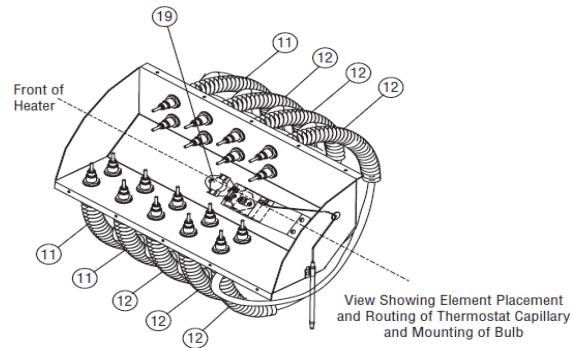



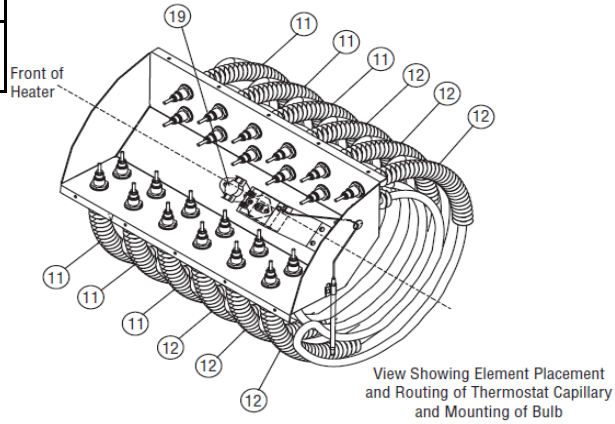

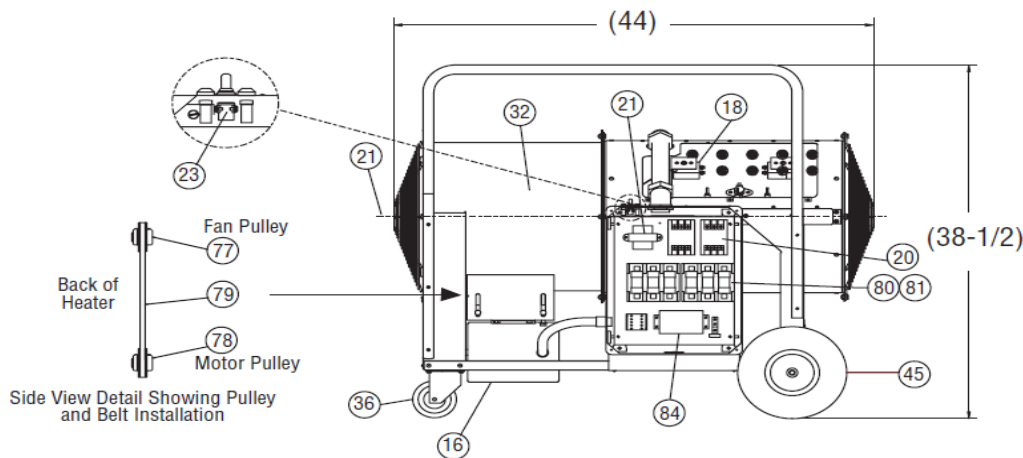

Element Assembly 48kW



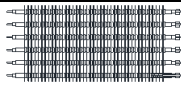
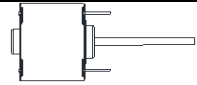
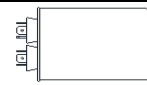



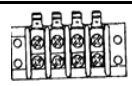
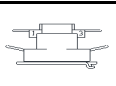
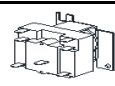

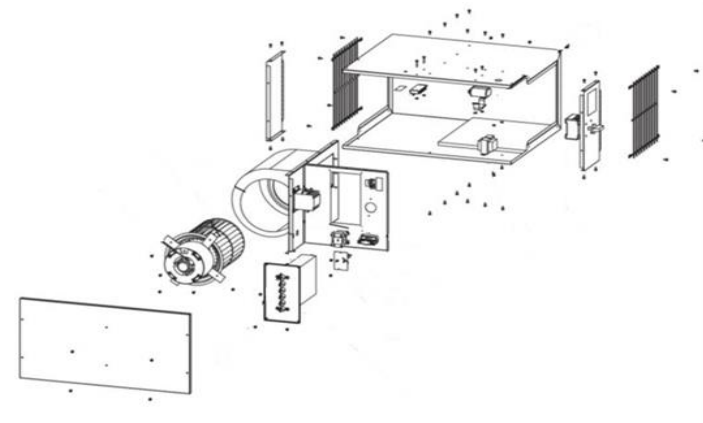
Element Assembly 60kW









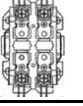
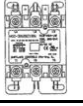
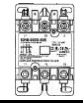
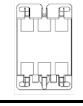
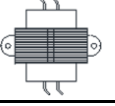
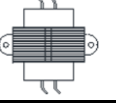

Side View shown with Heater and Control Terminal Box Covers Removed  
All Sizes

MSPH PLENUM RATED UNIT HEATER								
ELEMENT			MOTOR			CAPACITOR		
								
1802-10498-000 PRH1381240000 PRH1383240000	1802-10498-004 PRH11021240000 PRH11023240000	1802-10498-007 PRH1343240000	3900-10160-003 PRH11021240000 PRH11023240000	3900-10160-001 PRH11083240000 PRH11523240000	3900-2094-001 PRH1321240000 PRH1323240000	1432-0002-001 PRH11043240000 PRH11071240000 PRH11083240000 PRH11523240000 PRH11543240000 PRH11583240000 PRH1321240000 PRH1323240000 PRH1343240000 PRH1371240000 PRH1381240000 PRH1383240000 PRH1521240000 PRH1523240000 PRH1543240000 PRH1583240000		1432-0002-002 PRH1571240000 PRH1571240000 PRH1581240000 PRH1583240000 PRH17521240000 PRH17523240000 PRH17543240000 PRH17571240000 PRH17581240000 PRH17583240000 PRH21021240000 PRH2102240000 PRH21023240000 PRH21043240000 PRH21071240000 PRH21083240000 PRH21523240000 PRH21543240000
1802-10498-001 PRH1321240000 PRH1323240000	PRH11521240000 PRH11521240000 PRH1523240000	1802-10498-008 PRH11583240000 PRH17581240000 PRH17583240000	3900-10164-001 PRH11043240000 PRH11543240000 PRH1343240000	PRH11583240000 PRH1521240000 PRH1523240000 PRH1583240000	PRH1381240000 PRH1383240000 PRH1521240000 PRH1523240000	PRH11071240000 PRH11083240000 PRH11523240000 PRH11543240000 PRH11583240000 PRH1321240000 PRH1323240000 PRH1343240000 PRH1371240000 PRH1381240000 PRH1383240000 PRH1521240000 PRH1523240000 PRH1543240000 PRH1583240000	PRH1571240000 PRH1581240000 PRH1583240000 PRH21083240000	
1802-10498-002 PRH1371240000	PRH11523240000 PRH21021240000 PRH21023240000	1802-10498-009 PRH11523240000 PRH17521240000 PRH17523240000 PRH17543240000	PRH11523240000 PRH1543240000 PRH17543240000 PRH21043240000 PRH21543240000	PRH1583240000 PRH17521240000 PRH17523240000 PRH17581240000 PRH17583240000	PRH1581240000 PRH1583240000 PRH2095-001 PRH1371240000 PRH1571240000	PRH11043240000 PRH11071240000 PRH11083240000 PRH11523240000 PRH11543240000 PRH11583240000 PRH1321240000 PRH1323240000 PRH1343240000 PRH1371240000 PRH1381240000 PRH1383240000 PRH1521240000 PRH1523240000 PRH1543240000 PRH1583240000	PRH17521240000 PRH17523240000 PRH17543240000 PRH17571240000 PRH17581240000 PRH17583240000 PRH21021240000 PRH2102240000 PRH21023240000 PRH21043240000 PRH21071240000 PRH21083240000 PRH21523240000 PRH21543240000	
1802-10498-003 PRH11083240000 PRH1581240000 PRH1581240000 PRH1583240000 PRH1583240000 PRH21083240000	1802-10498-005 PRH11071240000 PRH1571240000 PRH1571240000 PRH21071240000	1802-10498-010 PRH17571240000	3900-10162-001 PRH11071240000 PRH1571240000 PRH17571240000 PRH21071240000	PRH1583240000 PRH21021240000 PRH21023240000 PRH21523240000		PRH11043240000 PRH11071240000 PRH11083240000 PRH11523240000 PRH11543240000 PRH11583240000 PRH1321240000 PRH1323240000 PRH1343240000 PRH1371240000 PRH1381240000 PRH1383240000 PRH1521240000 PRH1523240000 PRH1543240000 PRH1583240000	PRH1571240000 PRH1581240000 PRH1583240000 PRH21043240000 PRH21071240000 PRH21083240000 PRH21523240000 PRH21543240000	1802-10498-006 PRH11043240000 PRH1543240000 PRH1543240000 PRH21043240000
BLOWER ASSEMBLY			LIMIT			GRILLE		
								
1225-10158-000 PRH11021240000 PRH11023240000 PRH11043240000 PRH11071240000 PRH11083240000 PRH11523240000 PRH11543240000 PRH11583240000 PRH1521240000 PRH1523240000 PRH1543240000 PRH1571240000 PRH1581240000 PRH1571240000 PRH1581240000 PRH1583240000	1225-2022-000 PRH1321240000 PRH1323240000 PRH1343240000 PRH1371240000 PRH1381240000 PRH1383240000 PRH1521240000 PRH1523240000 PRH1543240000 PRH1571240000 PRH1581240000 PRH1583240000	1414-2040-001 PRH11021240000 PRH11023240000 PRH11043240000 PRH11071240000 PRH11083240000 PRH11523240000 PRH11543240000 PRH11583240000 PRH1521240000 PRH1523240000 PRH1543240000 PRH1571240000 PRH1581240000 PRH1571240000 PRH1581240000 PRH1583240000	1414-2040-000 PRH1321240000 PRH1323240000 PRH1343240000 PRH1371240000 PRH1381240000 PRH1383240000 PRH1521240000 PRH1523240000 PRH1543240000 PRH1571240000 PRH1581240000 PRH1583240000	2501-10156-800 PRH11021240000 PRH11023240000 PRH11043240000 PRH11071240000 PRH11083240000 PRH11523240000 PRH11543240000 PRH11583240000 PRH1521240000 PRH1523240000 PRH1543240000 PRH1571240000 PRH1581240000 PRH1571240000 PRH1581240000 PRH1583240000	312056803 PRH1321240000 PRH1323240000 PRH1343240000 PRH1371240000 PRH1381240000 PRH1383240000 PRH1521240000 PRH1523240000 PRH1543240000 PRH1571240000 PRH1581240000 PRH1583240000			
TRANSFORMER			TERMINAL BLOCK			TIME DELAY RELAY	FAN RELAY	DISCONNECT SW.
								
5814-0003-000 PRH11021240000 PRH11023240000 PRH11083240000 PRH11523240000 PRH11583240000 PRH1321240000 PRH1323240000 PRH1381240000 PRH1383240000 PRH1521240000 PRH1521240000 PRH1523240000 PRH1523240000	5814-0003-001 PRH11071240000 PRH11571240000 PRH1571240000 PRH17571240000 PRH21071240000	480106001 PRH11021240000 PRH11023240000 PRH11043240000 PRH11071240000 PRH11083240000 PRH11523240000 PRH11543240000 PRH11583240000 PRH1321240000 PRH1323240000 PRH1343240000 PRH1371240000 PRH1381240000 PRH1383240000 PRH1521240000 PRH1521240000	480106002 PRH21021240000 PRH21023240000 PRH21043240000 PRH21071240000 PRH21083240000 PRH21543240000	410171001 ALL MODELS	5018-2024-000 ALL MODELS	5216-2039-000 ALL MODELS		
PRH11021240000 PRH11023240000 PRH11083240000 PRH11523240000 PRH11583240000 PRH1321240000 PRH1323240000 PRH1381240000 PRH1383240000 PRH1521240000 PRH1521240000 PRH1523240000 PRH1523240000	PRH11581240000 PRH1583240000 PRH17521240000 PRH17523240000 PRH17571240000 PRH21071240000	PRH11523240000 PRH11543240000 PRH11581240000 PRH1521240000 PRH1523240000 PRH1543240000 PRH1571240000 PRH1581240000 PRH1583240000	PRH1523240000 PRH1543240000 PRH1571240000 PRH1581240000 PRH1583240000	PRH21021240000 PRH21023240000 PRH21043240000 PRH21071240000 PRH21083240000 PRH21543240000	5018-0005-004 ALL MODELS			
								

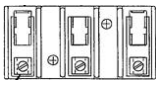
**MUH SERIES**











ELEMENT				MOTOR			CAPACITOR
QUANTITY OF ELEMENTS 3 THRU 10KW (3) 15 THRU 30KW (6) 40 & 50KW (9)							
<b>1802-0087-000</b> MUH0321	<b>1802-0087-004</b> MUH0571	<b>1802-0087-011</b> MUH104	<b>1802-0087-046</b> MUH256	<b>3900-2002-506</b> MUH0321	<b>3900-2014-004</b> MUH072	<b>3900-0364-000</b> MUH252	<b>1432-0002-003</b> MUH202
<b>1802-0087-040</b> MUH0331	<b>1802-0087-034</b> MUH0581	<b>1802-0087-010</b> MUH107	<b>1802-0087-018</b> MUH302	MUH0381	MUH073	MUH256	MUH204
<b>1802-0087-002</b> MUH0341	<b>1802-0087-025</b> MUH0581MG	<b>1802-0087-036</b> MUH108	<b>1802-0087-019</b> MUH304	MUH0521	MUH076	MUH302	MUH206
<b>1802-2073-000</b> MUH0361	<b>1802-0087-006</b> MUH072	<b>1802-0087-012</b> MUH152	<b>1802-0087-047</b> MUH306	MUH0521MG	MUH077	MUH306	MUH208
<b>1802-0087-001</b> MUH0371	<b>1802-0087-042</b> MUH073	<b>1802-0087-008</b> MUH154	<b>1802-0087-028</b> MUH308	MUH0581	MUH078	MUH308	MUH252
<b>1802-0087-024</b> MUH0381	<b>1802-0087-008</b> MUH074	<b>1802-2073-002</b> MUH156	<b>1802-0087-020</b> MUH402	MUH0581MG	MUH102	<b>3900-0363-500</b> MUH254	MUH254
<b>1802-0087-035</b> MUH0521	<b>1802-2073-002</b> MUH076	<b>1802-0087-037</b> MUH158	<b>1802-0087-021</b> MUH404	<b>3900-2002-516</b> MUH0331	MUH103	MUH304	<b>1432-0002-001</b> MUH254A
<b>1802-0087-003</b> MUH0521MG	<b>1802-0087-007</b> MUH077	MUH202	<b>1802-0087-048</b> MUH406	MUH0361	MUH106	<b>3900-2065-000</b> MUH254A	MUH304A
<b>1802-0087-041</b> MUH0531	<b>1802-0087-031</b> MUH078	<b>1802-0087-026</b> MUH208	<b>1802-0087-022</b> MUH502	MUH0531	MUH107	MUH304A	MUH308
<b>1802-0087-005</b> MUH0541	MUH102	<b>1802-0087-016</b> MUH252	<b>1802-0087-023</b> MUH504	MUH0561	MUH108	MUH304A	<b>1432-0002-004</b> MUH402
<b>1802-2073-001</b> MUH0561	<b>1802-0087-044</b> MUH103	<b>1802-0087-017</b> MUH254	<b>1802-0087-049</b> MUH506	<b>3900-2005-000</b> MUH0341	<b>3900-0361-501</b> MUH154	<b>3900-0350-000</b> MUH402	MUH404
	MUH106	MUH254A	<b>1802-0087-030</b> MUH508	MUH0541	<b>3900-0361-003</b> MUH156	MUH502	MUH406
	MUH206			<b>3900-2002-507</b> MUH0371	<b>3900-0362-000</b> MUH202	MUH506	MUH502
				MUH0571	MUH206	<b>3900-0350-001</b> MUH404	MUH504
				<b>3900-0347-005</b> MUH074	<b>3900-0362-001</b> MUH204	MUH406	MUH508
				MUH104	<b>3900-0362-002</b> MUH208	<b>3900-0350-002</b> MUH508	
				<b>3900-0361-500</b> MUH152			
				MUH158			
PROTECTOR LIMIT				FAN DELAY	FAN BLADE		HI/LOW SP. SWITCH
							
<b>4520-0011-000</b> MUH0321	<b>4520-0011-001</b> MUH072	<b>4520-0011-002</b> MUH252	<b>4520-0010-000</b> ALL MODELS	<b>1210-2000-000</b> MUH0321	<b>1210-0090-000</b> MUH072	<b>1210-0098-000</b> MUH252	<b>5216-2053-000</b> MUH252
MUH0331	MUH073	MUH254		MUH0331	MUH073	MUH254	MUH254
MUH0341	MUH074	MUH254A		MUH0341	MUH074	MUH254A	MUH254A
MUH0361	MUH076	MUH256		MUH0361	MUH076	MUH256	MUH256
MUH0371	MUH077	MUH302		MUH0371	MUH077	MUH302	MUH302
MUH0381	MUH078	MUH304		MUH0381	MUH078	MUH304	MUH304
MUH0521	MUH102	MUH304A		MUH0521	MUH102	MUH304A	MUH304A
MUH0521MG	MUH103	MUH306		MUH0521MG	MUH103	MUH306	MUH306
MUH0531	MUH104	MUH308		MUH0531	MUH104	MUH308	MUH308
MUH0541	MUH106	MUH402		MUH0541	MUH106	MUH402	MUH402
MUH0561	MUH107	MUH404		MUH0561	MUH107	MUH404	MUH404
MUH0571	MUH108	MUH406		MUH0571	MUH108	MUH406	MUH406
MUH0581	MUH152	MUH502		MUH0581	MUH152	MUH502	MUH502
MUH0581MG	MUH154	MUH504		MUH0581MG	MUH154	MUH504	MUH504
	MUH156	MUH506			<b>1210-0090-001</b> MUH152	MUH506	MUH506
	MUH158	MUH508			MUH154	MUH508	MUH508
	MUH202				MUH156		
	MUH204				MUH158		
	MUH206				<b>1210-0096-000</b> MUH202		
	MUH208				MUH204		
					MUH206		
					MUH208		
RELAY				POWER TR			SECONDARY TR
							
<b>5018-0003-000</b> MUH0331	<b>5018-0004-100</b> MUH0341	<b>5018-0005-004</b> MUH152	<b>5018-0006-000</b> MUH202	<b>5814-0003-000</b> MUH072	<b>5814-0003-002</b> MUH0341	<b>490015017</b> MUH0331	<b>5814-0003-000</b> MUH0331
MUH0531	MUH0361	MUH158	MUH308	MUH102	MUH0541	MUH0531	MUH0361
MUH072	MUH0541	MUH208	MUH504	MUH108	MUH074	<b>490015018</b> MUH073	MUH0531
MUH073	MUH0561	MUH252	MUH508	MUH152	MUH104	MUH103	MUH0561
MUH077	MUH074	MUH254		MUH158	MUH154	MUH106	MUH073
MUH078	MUH076	MUH254A		MUH202	MUH204	<b>490015021</b> MUH076	MUH076
MUH102	MUH104	MUH302		MUH208	MUH254	MUH106	MUH103
MUH103	MUH106	MUH304		MUH252	MUH254A	<b>490026007</b> MUH402	MUH206
MUH107	MUH108	MUH304A		MUH302	MUH304	MUH406	MUH256
<b>5018-0003-002</b> MUH0521MG	MUH154	MUH402		MUH308	MUH304A	MUH502	MUH306
MUH0581MG	MUH156	MUH404		<b>5814-0003-001</b> MUH077	MUH404	MUH508	MUH406
	MUH204	MUH406		MUH078	MUH504		MUH506
	MUH206	MUH502		MUH107	<b>490015013</b> MUH0361		<b>5814-2009-000</b> MUH106
	MUH256	MUH506		<b>490015012</b> MUH156	MUH0561		MUH156
	MUH306			MUH158	<b>490015015</b> MUH406		
	MUH404			MUH206	MUH506		
	MUH406			MUH256			
	MUH504			MUH306			
	MUH506						

MUH CONTINUED

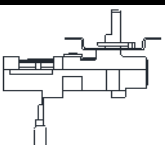
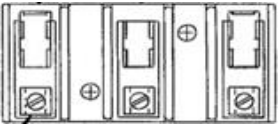
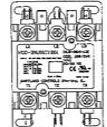

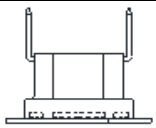

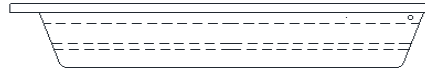





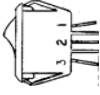

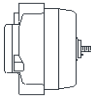

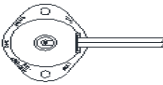
CONTROL BOARD		POWER BLOCK				
						
<b>5823-0001-000</b> MUH0321 MUH0371 MUH0381 MUH0521 MUH0571 MUH0581	<b>5823-0002-000</b> MUH0331 MUH0341 MUH0361 MUH0521MG MUH0531 MUH0541 MUH0561 MUH0581MG MUH072 MUH073 MUH074 MUH076 MUH077 MUH078 MUH102 MUH103 MUH104 MUH106 MUH107 MUH108 MUH152 MUH154 MUH156 MUH158	MUH202 MUH204 MUH206 MUH208 MUH252 MUH254 MUH254A MUH256 MUH302 MUH304 MUH304A MUH306 MUH308 MUH402 MUH404 MUH406 MUH502 MUH504 MUH506 MUH508	<b>5823-0004-000</b> MUH0321 MUH0331 MUH0341 MUH0361 MUH0371 MUH0381 MUH0521 MUH0521MG MUH0531 MUH0541 MUH0561 MUH0571 MUH0581 MUH0581MG MUH072 MUH073	MUH074 MUH076 MUH077 MUH078 MUH102 MUH103 MUH104 MUH106 MUH107 MUH108 MUH154 MUH156 MUH204 MUH206 MUH256 MUH306	<b>5823-0004-001</b> MUH152 MUH254 MUH254A MUH304 MUH304A	
				<b>5823-0004-002</b> MUH202 MUH208 MUH252 MUH404 MUH406 MUH504 MUH506		
				<b>5823-0004-003</b> MUH158 MUH302		
				<b>5823-0005-000</b> MUH308 MUH402 MUH502 MUH508		
<b>QUANTITY</b> 3&5KW (5) 7 THRU 20KW (6) 25 THRU 50KW (9)						
<b>3503-2004-006</b> MUH0321 MUH0331 MUH0341 MUH0361 MUH0371 MUH0381 MUH0521 MUH0521MG MUH0531 MUH0541 MUH0561 MUH0571 MUH0581 MUH0581MG	<b>3503-2004-001</b> MUH072 MUH073 MUH074 MUH076 MUH077 MUH078 MUH102 MUH103 MUH104 MUH106 MUH107 MUH108 MUH152 MUH154 MUH156 MUH158 MUH202 MUH204 MUH206 MUH208	<b>3503-2004-008</b> MUH252 MUH254 MUH254A MUH256 MUH302 MUH304 MUH304A MUH306 MUH308 MUH402 MUH404 MUH406 MUH502 MUH504 MUH506 MUH508	<b>5208-7005-001</b> ALL MODELS	<b>2025-0002-000</b> MUH158 MUH208	<b>2019-0007-010</b> MUH158	
				<b>480030004</b> MUH252 MUH302 MUH308 MUH402 MUH502 MUH508	<b>2019-0007-008</b> MUH208	
				<b>2025-0001-000</b> MUH504 MUH506	<b>2019-7008-077</b> MUH252	
				<b>2025-7004-000</b> MUH504 MUH506	<b>2019-7008-079</b> MUH302 MUH502	
					<b>2019-7008-080</b> MUH308 MUH508	
					<b>2019-7008-078</b> MUH402	
					<b>2019-7002-008</b> MUH504	
					<b>2019-7002-007</b> MUH506	
					<b>2019-7002-012</b> MUH504	
					<b>2019-7002-011</b> MUH506	



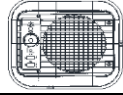





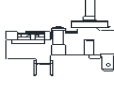
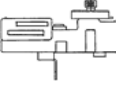



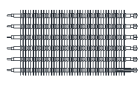

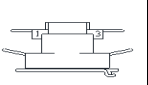
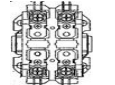
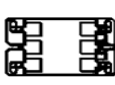
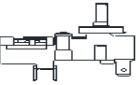
## MWUH SERIES

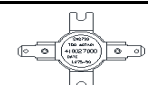
ELEMENT		MOTOR	FAN BLADE	KNOB	THERMOSTAT
					
<b>302006807</b> MWUH5004 MWUH5004A  <b>302006810</b> UH724ST UH724STA	<b>302006847</b> MWUH5008 MWUH5008A	<b>3900-2008-000</b> MWUH5004 MWUH5004A MWUH5008 MWUH5008A UH724ST UH724STA	<b>1210-2017-000</b> MWUH5004 MWUH5004A MWUH5008 MWUH5008A UH724ST UH724STA	<b>3301-2014-006</b> MWUH5004 MWUH5004A MWUH5008 MWUH5008A UH724ST UH724STA	<b>5813-2050-000</b> MWUH5004 MWUH5004A MWUH5008 MWUH5008A UH724ST UH724STA
POWER BLOCK		RELAY	HI LIMIT	FAN DELAY	LIGHT
					
<b>5823-0004-005</b> MWUH5004 MWUH5004A MWUH5008 MWUH5008A	<b>5823-0004-000</b> UH724ST UH724STA	<b>5018-0004-102</b> UH724ST UH724STA	<b>410027000</b> MWUH5004 MWUH5004A MWUH5008 MWUH5008A UH724ST UH724STA	<b>410148000</b> MWUH5004 MWUH5004A MWUH5008 MWUH5008A UH724ST UH724STA	<b>3510-2017-003</b> MWUH5004A UH724STA
LOUVERS		LOUVER SPRING	MT. BRACKET		
					
<b>3503-2004-009</b> MWUH5004 MWUH5004A MWUH5008 MWUH5008A	<b>3503-2004-010</b> UH724ST UH724STA	<b>5208-7005-001</b> MWUH5004 MWUH5004A MWUH5008 MWUH5008A UH724ST UH724STA	<b>310876001</b> MWUH5004 MWUH5004A MWUH5008 MWUH5008A UH724ST UH724STA		

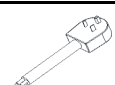

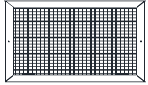





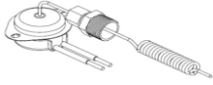

QPH4A & MUH35 SERIES					
ROCKER SWITCH**	FAN BLADE		ELEMENT***		MOTOR
					
S99814893A000 MUH35 MUH35B MUH35C MUH35D PH4A PH4AB NPH4AB NPH4ABA	1210-2000-000 MUH35 MUH35B MUH35C MUH35D PH4 PH4A	1210-2000-001 PH4AB NPH4AB NPH4ABA	1802-0087-032 MUH35 MUH35B MUH35C MUH35D	1802-0087-038 PH4 PH4A PH4AB NPH4AB NPH4ABA	3900-2002-506 MUH35 MUH35B MUH35C MUH35D PH4 PH4A PH4AB NPH4AB NPH4ABA
FAN DELAY	MANUAL RESET		LIMIT		BUZZER
					
4520-0010-000 MUH35C MUH35D	4520-2017-000 MUH35B MUH35C PH4A	4520-11004-000 PH4AB NPH4AB	4520-11004-002 MUH35D NPH4ABA	4520-0011-000 MUH35 PH4	2714-11001-000 MUH35D
STAND	CONTROL COVER	GRILLE	GUARD	T'STAT KNOB	STAND KNOB**
					
5210-2000-002 MUH35B MUH35C MUH35D PH4A PH4AB NPH4AB NPH4ABA	1402-0336-000 MUH35 MUH35B MUH35C MUH35D PH4 PH4AB NPH4AB NPH4ABA	1402-2154-001 MUH35B MUH35C MUH35D PH4AB NPH4AB NPH4ABA	2504-0011-001 MUH35B MUH35C MUH35D PH4 PH4AB NPH4AB NPH4ABA	3301-2012-001 MUH35B MUH35C MUH35D PH4AB NPH4AB NPH4ABA	3301-2018-000 MUH35 MUH35B MUH35C MUH35D PH4AB NPH4AB NPH4ABA
LIGHT	CORD	THERMOSTAT			
					
3510-2007-000 MUH35B MUH35C MUH35D	1420-2028-000 PH4AB 1420-11012-000 NPH4AB NPH4ABA	5813-2018-000 MUH35 MUH35B MUH35C MUH35D PH4A PH4AB NPH4AB NPH4ABA	5813-0047-000 PH4		
NOTE * INDICATES QUANTITY					

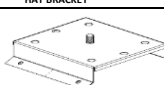

**TBX SERIES**

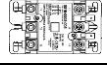

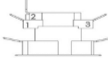
ELEMENT	MOTOR	TIME DELAY RELAY	CONTACTOR 30AMP	CONTACTOR 50AMP	THERMOSTAT
					
302006814 TBX754	490059004 ALL MODELS	410171003 ALL MODELS	5018-0003-002 ALL MODELS	5018-0006-002 ALL MODELS	5813-2059-000 ALL MODELS
302006813 TBX104					
					
490011001 ALL MODELS	410169001 ALL MODELS	480100001 ALL MODELS	1016-0193-800 ALL MODELS	1016-10593-000 ALL MODELS	3301-2053-000 ALL MODELS
					
1017-0004-000 ALL MODELS	2501-10513-800 ALL MODELS	2710-10586-000 ALL MODELS	2710-2012-800 ALL MODELS	6406-0002-000 ALL MODELS	1408-10584-000 ALL MODELS



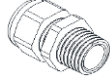

QWD SERIES WASHDOWN UNIT HEATER																										
MOTOR						BLADE																				
<b>3900-11029-000</b> WD02212A WD07212A WD02812A WD07232A WD03212A WD07412A WD03232A WD07432A WD03432A WD07632A WD03812A WD07812A WD03832A WD07831A WD05212A WD07832A WD05232A WD10212A WD05412A WD10232A WD05431A WD10412A WD05432A WD10432A WD05632A WD10632A WD05812A WD10832A WD05832A			<b>3900-11029-001</b> WD05712A WD12212A WD07712A WD12432A WD10712A WD12632A <b>3900-11029-002</b> WD02112A WD12832A WD03112A WD15212A WD15232A WD30431A WD15412A WD30432A WD15432A WD30631A WD15632A WD30632A WD15812A WD30832A WD15832A WD39432A WD2032A WD394632A WD20412A			<b>3900-11031-000</b> WD20432A WD12232A WD20632A WD12432A WD25232A WD12632A WD25432A WD12812A WD25632A WD12812A WD25832A WD12832A WD30232A WD15212A WD30431A WD15232A WD30432A WD15412A WD30631A WD15432A WD30632A WD15632A WD30832A WD15812A WD39432A WD15832A WD394632A			<b>1210-11007-002</b> WD10232A WD10412A WD10422A WD10432A WD10632A WD10712A WD10832A WD10712A WD12212A WD12232A WD12322A WD12432A WD12632A WD12652A WD12812A WD12832A		<b>1210-11007-003</b> WD02112A WD05712A WD02812A WD05812A WD03212A WD05832A WD03222A WD07212A WD03232A WD07232A WD03432A WD07412A WD03712A WD07432A WD03812A WD07632A WD03832A WD07712A WD05212A WD07812A WD05232A WD07831A WD05412A WD07832A WD05431A WD10212A WD05432A		<b>1210-11008-003</b> WD15212A WD25432A WD15412A WD25432A WD15432A WD30232A WD15632A WD30232A WD15812A WD30232A WD15832A WD30232A WD20232A WD20432A WD20632A WD20632A WD25232A WD25432A WD25432A WD394632A													
ELEMENT						LIMIT																				
<b>QUANTITY REQ</b> 2KW (2) 3 THRU 15KW (3) 20 THRU 39KW (6)																										
<b>1802-11012-001</b> WD02112A WD05212A WD03112A WD05232A			<b>1802-11012-006</b> WD07812A WD07831A WD07832A WD0832A WD08312A WD0832A WD08322A WD05712A			<b>1802-11012-011</b> WD07812A WD07831A WD07832A WD10212A WD10232A WD10232A <b>1802-11012-012</b> WD07212A WD07232A WD07412A WD07432A <b>1802-11012-013</b> WD10412A WD10432A			<b>1802-11013-001</b> WD12812A WD12832A <b>1802-11013-002</b> WD12212A WD12232A WD25232A WD25232A <b>1802-11013-003</b> WD12432A WD12432A WD25432A WD25432A <b>1802-11013-004</b> WD15812A WD15832A WD30832A WD30832A <b>1802-11013-007</b> WD20232A WD20232A			<b>1802-11013-005</b> WD15212A WD15232A WD15412A WD15432A <b>1802-11013-006</b> WD15412A WD15432A WD39431A WD394632A			<b>1802-11013-021</b> WD12632A WD12632A <b>1802-11013-022</b> WD15632A WD30631A WD30632A WD30632A <b>1802-11013-023</b> WD394632A WD394632A			<b>4520-11013-000</b> WD02112A WD05832A WD02212A WD07212A WD02812A WD07232A WD03112A WD07412A WD03212A WD07432A WD03232A WD07632A WD03432A WD07712A WD03712A WD07812A WD03812A WD07831A WD03832A WD07832A WD05212A WD10212A WD05232A WD10232A WD05412A WD10412A WD05431A WD10432A WD05432A WD10632A WD05632A WD10712A WD05712A WD10832A			<b>4520-11013-001</b> WD12212A WD12232A WD12432A WD12432A WD12632A WD12632A WD12812A WD12812A WD12832A WD12832A WD15212A WD15232A WD15412A WD15432A WD15432A WD15432A WD15632A WD15632A WD15812A WD15812A WD15832A WD15832A WD20232A WD20232A WD20412A WD20412A			WD20432A WD20632A WD25232A WD25232A WD25432A WD25432A WD25632A WD25632A WD25832A WD25832A WD30232A WD30232A WD30431A WD30431A WD30432A WD30432A WD30631A WD30631A WD30632A WD30632A WD30832A WD30832A WD39432A WD39432A WD394632A WD394632A		
WALL/CEILING BRK				HAT BRACKET				FUSE BLOCK (2 REQ)		FUSE																
																										
<b>1215-11082-000</b> WD02112A WD05832A WD02212A WD07212A WD02812A WD07232A WD03212A WD07412A WD03232A WD07432A WD03432A WD07632A WD03812A WD07812A WD03832A WD07831A WD05212A WD07832A WD05232A WD10212A WD05412A WD10232A WD05431A WD10412A WD05432A WD10432A WD05632A WD10712A WD05812A WD10832A		<b>1215-11082-001</b> WD12212A WD20432A WD12232A WD20632A WD12432A WD25232A WD12632A WD25432A WD12812A WD25632A WD12832A WD25832A WD15212A WD30232A WD15232A WD30431A WD15412A WD30432A WD15432A WD30631A WD15632A WD30632A WD15812A WD30832A WD15832A WD39432A WD10432A WD394632A WD20412A		<b>1016-11218-000</b> WD02112A WD05832A WD02212A WD07212A WD02812A WD07232A WD03212A WD07412A WD03232A WD07432A WD03432A WD07632A WD03812A WD07712A WD03832A WD07812A WD15412A WD07831A WD15432A WD07832A WD15632A WD10212A WD15812A WD10232A WD15832A WD10412A WD10432A WD10432A WD10632A WD10632A WD10712A WD10712A WD10832A WD10832A WD05812A		<b>1016-11218-001</b> WD12212A WD20432A WD12232A WD20632A WD12432A WD25232A WD12632A WD25432A WD12812A WD25632A WD12832A WD25832A WD15212A WD30232A WD15232A WD30431A WD15412A WD30432A WD15432A WD30631A WD15632A WD30632A WD15812A WD30832A WD15832A WD39432A WD20232A WD394632A WD20412A		<b>480030004</b> WD12212A WD12232A WD12812A WD12812A WD15212A WD15212A WD15812A WD15812A WD20232A WD20232A WD25232A WD25232A WD25832A WD25832A WD30232A WD30232A WD30431A WD30431A WD30432A WD30432A WD30631A WD30631A WD30632A WD30632A WD30832A WD30832A		<b>FUSE 35A</b> 2019-11003-072 WD12212A WD12812A WD15212A WD15812A WD15832A WD15832A WD20232A WD20232A <b>FUSE 45A</b> 2019-11003-078 WD12212A WD25232A WD25832A <b>FUSE 50A</b> 2019-11003-079 WD12812A WD30232A <b>FUSE 60A</b> 2019-11003-080 WD15212A WD15812A WD30832A																
CONTACTOR 50A				CONTACTOR				TRANSFORMER		TRANSFORMER 600V																
																										
<b>5018-0006-000</b> WD05712A WD05632A WD02212A WD05812A WD02812A WD05832A WD03112A WD07212A WD03212A WD07232A WD03232A WD07412A WD03432A WD07432A WD03712A WD07632A WD03812A WD07712A WD03832A WD07812A WD05212A WD07832A WD05232A WD07831A WD05412A WD10232A WD05432A WD10412A WD05632A WD10432A		WD10632A WD15832A WD10712A WD20232A WD10832A WD20412A WD12212A WD20432A WD12232A WD20632A WD12432A WD25232A WD12632A WD25432A WD12812A WD25632A WD15212A WD30232A WD15232A WD30432A WD15412A WD30632A WD15432A WD30832A WD15632A WD39432A WD15812A WD394632A		<b>5018-0006-001</b> WD05431A WD07831A WD30431A WD30631A		<b>5018-0005-004</b> WD05632A WD07632A WD10632A WD10632A WD12632A WD15632A WD20632A WD25632A WD25632A WD30631A WD30632A WD394632A		<b>5814-0003-000</b> WD02212A WD02812A WD03212A WD03232A WD03812A WD03832A WD07412A WD07432A WD07812A WD07831A WD07832A WD07832A WD10412A WD10432A WD10632A WD10632A WD10712A WD10712A WD10832A		<b>5814-0003-002</b> WD03432A WD05412A WD05431A WD05432A WD07412A WD07432A WD10412A WD10432A WD10432A WD15412A WD15432A WD15432A WD20412A WD20432A WD20432A WD25432A WD30432A WD30432A WD39432A WD39432A WD10212A		<b>490015027</b> WD05632A WD07632A WD10632A WD12632A WD15632A WD15632A WD20632A WD20632A WD25632A WD30631A WD30632A WD394632A														
FAN RELAY																										
																										
<b>5018-11005-000</b> WD05712A WD05632A WD02212A WD05812A WD02812A WD05832A WD03112A WD07212A WD03212A WD07232A WD03232A WD07412A WD03432A WD07432A WD03712A WD07632A WD03812A WD07712A WD03832A WD07812A WD05212A WD07832A WD05232A WD07831A WD05412A WD10232A WD05432A WD10412A WD05632A WD10432A		WD10632A WD15832A WD10712A WD20232A WD10832A WD20412A WD12212A WD20432A WD12232A WD20632A WD12432A WD25232A WD12632A WD25432A WD12812A WD25632A WD15212A WD30232A WD15232A WD30432A WD15412A WD30632A WD15432A WD30832A WD15632A WD39432A WD15812A WD394632A		<b>5018-11005-001</b> WD05431A WD07831A WD30431A WD30631A		<b>5814-0003-001</b> WD12232A WD12632A WD12812A WD12812A WD12832A WD12832A WD15212A WD15212A WD15232A WD15232A WD15632A WD15632A WD15812A WD15812A WD15832A WD15832A WD20232A WD20232A WD20632A WD20632A WD25232A WD25232A WD25632A WD25832A WD30232A WD30232A WD30632A WD30632A WD30832A WD30832A WD394632A																				

**QWD WASHDOWN CONTINUED**

CAPACITOR			STRAIGHT FITTING	SILICONE SEAL	TERMINAL BLOCK
				PICTURE NOT AVAILABLE 	
<b>1432-0002-001</b> WD02112A WD02212A WD02812A WD03112A WD03212A WD03232A WD03432A WD03812A WD03832A WD05212A WD05232A WD05412A WD05431A WD05432A WD05632A WD05812A	<b>1432-0002-003</b> WD03712A WD05712A WD07712A WD10712A	<b>1432-0002-004</b> WD12212A WD12232A WD12432A WD12632A WD12812A WD12832A WD15212A WD15232A WD15412A WD15432A WD15632A WD15812A WD15832A WD20232A WD20412A	<b>1213-2009-000</b> ALL MODELS	<b>5250-2001-000</b> ALL MODELS	<b>5823-2006-000</b> ALL MODELS

GRILLE INLET	GRILLE OUTLET
	

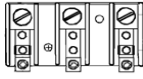
2504-11018-000		2504-11020-000		2504-11019-001		2504-11021-001	
WD02112A	WD05832A	WD12212A	WD20432A	WD02112A	WD05832A	WD12212A	WD20432A
WD02212A	WD07212A	WD12232A	WD20632A	WD02212A	WD07212A	WD12232A	WD20632A
WD02812A	WD07232A	WD12432A	WD25232A	WD02812A	WD07232A	WD12432A	WD25232A
WD03112A	WD07412A	WD12632A	WD25432A	WD03112A	WD07412A	WD12632A	WD25432A
WD03212A	WD07432A	WD12812A	WD25632A	WD03212A	WD07432A	WD12812A	WD25632A
WD03232A	WD07632A	WD12832A	WD25832A	WD03232A	WD07632A	WD12832A	WD25832A
WD03432A	WD07712A	WD15212A	WD30232A	WD03432A	WD07712A	WD15212A	WD30232A
WD03712A	WD07812A	WD15232A	WD30431A	WD03712A	WD07812A	WD15232A	WD30431A
WD03812A	WD07831A	WD15412A	WD30432A	WD03812A	WD07831A	WD15412A	WD30432A
WD03832A	WD07832A	WD15432A	WD30631A	WD03832A	WD07832A	WD15432A	WD30631A
WD05212A	WD10212A	WD15632A	WD30632A	WD05212A	WD10212A	WD15632A	WD30632A
WD05232A	WD10232A	WD15812A	WD30832A	WD05232A	WD10232A	WD15812A	WD30832A
WD05412A	WD10412A	WD15832A	WD39432A	WD05412A	WD10412A	WD15832A	WD39432A
WD05431A	WD10432A	WD20232A	WD394632A	WD05431A	WD10432A	WD20232A	WD394632A
WD05432A	WD10632A	WD20412A		WD05432A	WD10632A	WD20412A	
WD05632A	WD10712A			WD05632A	WD10712A		
WD05712A	WD10832A			WD05712A	WD10832A		
WD05812A				WD05812A			

POWER BLOCK		
		
<b>5823-0004-002</b> WD02112A WD02212A WD02812A WD03112A WD03212A WD03232A WD03432A WD03712A WD03812A WD03832A WD05212A WD05232A WD05412A WD05431A WD05432A WD05712A	WD05812A WD05832A WD07212A WD07232A WD07412A WD07432A WD07712A WD07812A WD07831A WD07832A WD10212A WD10232A WD10412A WD10432A WD10712A WD10832A	WD12232A WD12432A WD12832A WD15232A WD15412A WD15432A WD15832A WD20412A WD20432A WD25432A WD30431A WD30432A WD39432A
<b>480034002</b> WD12212A WD12632A WD12812A WD15212A WD15632A WD15812A WD20232A WD20632A WD25232A WD25632A WD25832A WD30232A WD30631A WD30632A WD30832A WD394632A		

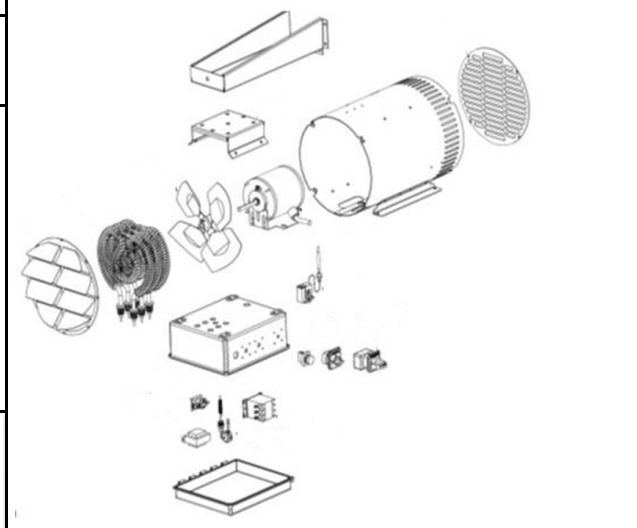









**Factory Installed Accessories**

CATALOG NUMBER	DESCRIPTION
T	Thermostat
L	Pilot Light
S	Mode/Selector Switch
D	Disconnect Switch
E	Monel Element*
M	Manual Reset
P	Epoxy Coating

PART	PART NUMBER
THERMOSTAT	SM/MD UNITS 4529-11010-000 LRG UNITS 4529-11010-001
PILOT LIGHT	120V CONTROL 4529-11009-002 24V CONTROL 4529-11009-001
MODE SWITCH	SM/MD UNITS 4529-11011-000 LRG UNITS 4529-11011-001
DISCONNECT SWITCH	40AMP 4529-11012-000 60AMP 4529-11012-001 100AMP 4529-11012-002 125AMP 4529-11012-003
MONEL ELEMENT	CONTACT FACTORY
MANUAL RESET	SM/MD UNITS 4529-11013-000 LRG UNITS 4529-11013-001
EPOXY COATING	CONTACT FACTORY



KCJ														
ELEMENT				LINEAR LIMIT			TR. RELAY							
														
1802-2056-003 J400B	1802-2044-001 J750B	1802-2044-014 J1007B	1802-2044-228 J1503B	4520-2018-000 J400B	4520-2018-003 J1000B	4520-2018-005 J1500B	5018-11003-003 J503B	410043007 J1006B						
1802-2056-001 J404B	1802-2044-210 J753B	1802-2044-016 J1008B	1802-2044-027 J1504B	J404B	J1003B	J1503B	J753B	J1256B						
1802-2056-000 J407B	1802-2044-009 J754B	1802-2044-023 J1250B	1802-2044-229 J1506B	J407B	J1004B	J1504B	J1003B	J1506B						
1802-2056-002 J408B	1802-2044-008 J757B	1802-2044-222 J1253B	1802-2044-026 J1507B	J408B	J1006B	J1506B	J1253B	J2006B						
1802-2044-043 J500B	1802-2044-010 J758B	1802-2044-021 J1254B	1802-2044-028 J1508B	4520-2018-001 J500B	J1007B	J1507B	J1503B							
1802-2044-202 J503B	1802-2044-017 J1000B	1802-2044-223 J1256B	1802-2044-234 J2003B	J503B	4520-2018-004 J1250B	4520-2018-006 J2003B	J2003B							
1802-2044-041 J504B	1802-2044-216 J1003B	1802-2044-020 J1257B	1802-2044-033 J2004B	J504B	J1253B	J2004B	J2004B							
1802-2044-040 J507B	1802-2044-015 J1004B	1802-2044-022 J1258B	1802-2044-235 J2006B	J507B	J1254B	J2006B	J2006B							
1802-2044-042 J508B	1802-2044-217 J1006B	1802-2044-029 J1500B	1802-2044-032 J2007B	J508B	J1256B	J2007B	J2007B							
			1802-2044-034 J2008B	4520-2018-002 J750B	J1257B	J2008B	J2008B							
				J753B	J1258B									
				J754B										
				J757B										
				J758B										
SWITCH		FRONT COVER			CONTROL COVER	THERMOSTAT								
														
5216-11007-000 J400B J404B J407B J408B J500B J504B J507B J508B J750B J754B J757B J758B J1000B J1004B		5216-2053-000 J503B J753B J1003B J1257B J1258B J1500B J1504B J1507B J1508B J2003B J2006B			1402-2192-006 J400B J404B J407B J408B 1402-2192-001 J500B J503B J504B J507B J508B 1402-2192-002 J750B J753B J754B J757B J758B		1402-2192-003 J1000B J1003B J1004B J1006B J1007B J1008B 1402-2192-004 J1250B J1253B J1254B J1256B J1257B J1258B		1402-2192-005 J1500B J1503B J1504B J1506B J1507B J1508B 1402-2192-007 J2003B J2004B J2006B J2007B J2008B		1402-11020-000 ALL MODELS		5813-0024-000 ALL MODELS	
														

**SHA & DBA SERIES**

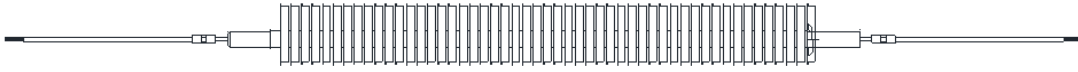

DISCRIPTION	PART NUMBERS					
	120V	208V	240V	277V	347V	600V
<b>*ELEMENT (100 WATTS/FT)</b>						
<b>28" HEATER</b>	1802-2001-047	1802-2001-048	1802-2001-049	NA	NA	NA
3'	1802-2001-053	1802-2001-054	1802-2001-055	1802-2001-056	NA	NA
4'	1802-2001-059	1802-2001-060	1802-2001-061	1802-2001-062	1802-2001-232	NA
5'	1802-2001-065	1802-2001-066	1802-2001-067	1802-2001-068	1802-2001-242	NA
6'	1802-2001-071	1802-2001-072	1802-2001-073	1802-2001-074	1802-2001-252	1802-2001-253
8'	NA	1802-2001-077	1802-2001-078	1802-2001-079	1802-2001-262	1802-2001-263
10'	NA	1802-2001-081	1802-2001-082	1802-2001-083	1802-2001-272	1802-2001-273
<b>*ELEMENT (125 WATTS/FT)</b>						
<b>28" HEATER</b>	1802-2001-085	1802-2001-086	1802-2001-048	1802-2001-049	NA	NA
3'	1802-2001-087	1802-2001-088	1802-2001-054	1802-2001-055	1802-2001-220	NA
4'	1802-2001-089	1802-2001-090	1802-2001-060	1802-2001-061	1802-2001-230	NA
5'	1802-2001-091	1802-2001-092	1802-2001-066	1802-2001-067	1802-2001-240	1802-2001-241
6'	1802-2001-093	1802-2001-094	1802-2001-072	1802-2001-073	1802-2001-250	1802-2001-251
8'	NA	1802-2001-095	1802-2001-077	1802-2001-078	1802-2001-260	1802-2001-261
10'	NA	1802-2001-096	1802-2001-081	1802-2001-082	1802-2001-270	1802-2001-271
<b>*ELEMENT (150 WATTS/FT)</b>						
<b>28" HEATER</b>	1802-2001-051	1802-2001-001	1802-2001-000	1802-2001-052	NA	NA
3'	1802-2001-057	1802-2001-007	1802-2001-006	1802-2001-058	1802-2001-218	NA
4'	1802-2001-063	1802-2001-013	1802-2001-012	1802-2001-064	1802-2001-228	NA
5'	1802-2001-069	1802-2001-019	1802-2001-018	1802-2001-070	1802-2001-238	1802-2001-239
6'	1802-2001-075	1802-2001-025	1802-2001-024	1802-2001-076	1802-2001-248	1802-2001-249
8'	NA	1802-2001-031	1802-2001-030	1802-2001-080	1802-2001-258	1802-2001-259
10'	NA	1802-2001-035	1802-2001-034	1802-2001-084	1802-2001-268	1802-2001-269
<b>*ELEMENT (188 WATTS/FT)</b>						
<b>28" HEATER</b>	1802-2001-005	1802-2001-002	1802-2001-001	1802-2001-000	NA	NA
3'	1802-2001-011	1802-2001-008	1802-2001-007	1802-2001-006	1802-2001-216	NA
4'	1802-2001-017	1802-2001-014	1802-2001-013	1802-2001-012	1802-2001-226	1802-2001-227
5'	1802-2001-023	1802-2001-020	1802-2001-019	1802-2001-018	1802-2001-236	1802-2001-237
6'	1802-2001-029	1802-2001-026	1802-2001-025	1802-2001-024	1802-2001-246	1802-2001-247
8'	NA	1802-2001-032	1802-2001-031	1802-2001-030	1802-2001-256	1802-2001-257
10'	NA	1802-2001-036	1802-2001-035	1802-2001-034	1802-2001-266	1802-2001-267
<b>*ELEMENT (250 WATTS/FT)</b>						
<b>28" HEATER</b>	1802-2001-004	1802-2001-003	1802-2001-002	1802-2001-001	1802-2001-202	NA
3'	1802-2001-010	1802-2001-009	1802-2001-008	1802-2001-007	1802-2001-214	NA
4'	1802-2001-016	1802-2001-015	1802-2001-014	1802-2001-013	1802-2001-224	1802-2001-225
5'	1802-2001-022	1802-2001-021	1802-2001-020	1802-2001-019	1802-2001-234	1802-2001-235
6'	1802-2001-028	1802-2001-027	1802-2001-026	1802-2001-025	1802-2001-244	1802-2001-245
8'	NA	1802-2001-033	1802-2001-032	1802-2001-031	1802-2001-254	1802-2001-255
10'	NA	1802-2001-037	1802-2001-036	1802-2001-035	1802-2001-264	1802-2001-265
* 1, 2 OR 3 ELEMENTS MAY BE REQUIRED. VOLTAGE AND WATTAGE ARE STAMPED ON END OF ELEMENTS. DIVIDE THE WATTAGE BY THE HEATER LENGTH (FEET) TO DETERMINE WATTS/FOOT OF ELEMENT. THEN USE THIS DATA TO DETERMINE PART NUMBER OF HEATING ELEMENT.						

DISCRIPTION	PART NUMBERS					
	120V	208V	240V	277V	347V	600V
<b>LINEAR LIMIT</b>						
<b>28" HEATER</b>	4520-0007-007	4520-0007-007	4520-0007-007	4520-0007-007	4520-0007-007	4520-0007-007
3'	4520-0007-008	4520-0007-008	4520-0007-008	4520-0007-008	4520-0007-008	4520-0007-008
4'	4520-0007-009	4520-0007-009	4520-0007-009	4520-0007-009	4520-0007-009	4520-0007-009
5'	4520-0007-010	4520-0007-010	4520-0007-010	4520-0007-010	4520-0007-010	4520-0007-010
6'	4520-0007-011	4520-0007-011	4520-0007-011	4520-0007-011	4520-0007-011	4520-0007-011
8'	NA	4520-0007-012	4520-0007-012	4520-0007-012	4520-0007-012	4520-0007-012
10'	NA	4520-0007-013	4520-0007-013	4520-0007-013	4520-0007-013	4520-0007-013
<b>DISCONNECT SW.</b>	<b>THERMOSTAT</b>	<b>TRANSFORMER</b>		<b>POWER RELAY</b>		
410170001	<b>2-STAGE</b> 5813-0023-000 <b>SINGLE POLE</b> 5813-0024-000	<b>120V</b> 5018-11003-000 <b>208/240V</b> 5018-11003-001	<b>277V</b> 5018-11003-002 <b>347V</b> 5018-11003-003	<b>24V</b> 5018-2006-000 <b>120V</b> 5018-2021-001	<b>208/240V</b> 5018-2006-002 <b>277V</b> 5018-2006-003	

**SLQDB SERIES**

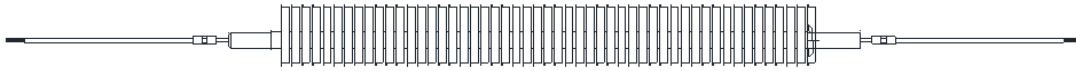



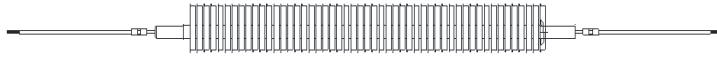

DISCRPTION	PART NUMBERS					
	120V	208V	240V	277V	347V	600V
<b>*ELEMENT (100 WATTS/FT)</b>						
<b>28" HEATER</b>	1802-2001-047	1802-2001-048	1802-2001-049	NA	NA	NA
3'	1802-2001-053	1802-2001-054	1802-2001-055	1802-2001-056	NA	NA
4'	1802-2001-059	1802-2001-060	1802-2001-061	1802-2001-062	1802-2001-232	NA
5'	1802-2001-065	1802-2001-066	1802-2001-067	1802-2001-068	1802-2001-242	NA
6'	1802-2001-071	1802-2001-072	1802-2001-073	1802-2001-074	1802-2001-252	1802-2001-253
8'	NA	1802-2001-077	1802-2001-078	1802-2001-079	1802-2001-262	1802-2001-263
10'	NA	1802-2001-081	1802-2001-082	1802-2001-083	1802-2001-272	1802-2001-273
<b>*ELEMENT (125 WATTS/FT)</b>						
<b>28" HEATER</b>	1802-2001-085	1802-2001-086	1802-2001-048	1802-2001-049	NA	NA
3'	1802-2001-087	1802-2001-088	1802-2001-054	1802-2001-055	1802-2001-220	NA
4'	1802-2001-089	1802-2001-090	1802-2001-060	1802-2001-061	1802-2001-230	NA
5'	1802-2001-091	1802-2001-092	1802-2001-066	1802-2001-067	1802-2001-240	1802-2001-241
6'	1802-2001-093	1802-2001-094	1802-2001-072	1802-2001-073	1802-2001-250	1802-2001-251
8'	NA	1802-2001-095	1802-2001-077	1802-2001-078	1802-2001-260	1802-2001-261
10'	NA	1802-2001-096	1802-2001-081	1802-2001-082	1802-2001-270	1802-2001-271
<b>*ELEMENT (150 WATTS/FT)</b>						
<b>28" HEATER</b>	1802-2001-051	1802-2001-001	1802-2001-000	1802-2001-052	NA	NA
3'	1802-2001-057	1802-2001-007	1802-2001-006	1802-2001-058	1802-2001-218	NA
4'	1802-2001-063	1802-2001-013	1802-2001-012	1802-2001-064	1802-2001-228	NA
5'	1802-2001-069	1802-2001-019	1802-2001-018	1802-2001-070	1802-2001-238	1802-2001-239
6'	1802-2001-075	1802-2001-025	1802-2001-024	1802-2001-076	1802-2001-248	1802-2001-249
8'	NA	1802-2001-031	1802-2001-030	1802-2001-080	1802-2001-258	1802-2001-259
10'	NA	1802-2001-035	1802-2001-034	1802-2001-084	1802-2001-268	1802-2001-269
<b>*ELEMENT (188 WATTS/FT)</b>						
<b>24" HEATER</b>	1802-2001-038	1802-2001-039	1802-2001-040	1802-2001-041	1802-2001-200	NA
<b>28"</b>	1802-2001-005	1802-2001-002	1802-2001-001	1802-2001-000	NA	NA
3'	1802-2001-011	1802-2001-008	1802-2001-007	1802-2001-006	1802-2001-216	NA
4'	1802-2001-017	1802-2001-014	1802-2001-013	1802-2001-012	1802-2001-226	1802-2001-227
5'	1802-2001-023	1802-2001-020	1802-2001-019	1802-2001-018	1802-2001-236	1802-2001-237
6'	1802-2001-029	1802-2001-026	1802-2001-025	1802-2001-024	1802-2001-246	1802-2001-247
8'	NA	1802-2001-032	1802-2001-031	1802-2001-030	1802-2001-256	1802-2001-257
10'	NA	1802-2001-036	1802-2001-035	1802-2001-034	1802-2001-266	1802-2001-267
<b>LINEAR LIMIT</b>		<b>DISCONNECT SW.</b>	<b>THERMOSTAT</b>			
<b>28" HEATER</b>	4520-0007-007	410170001	<b>2-STAGE</b>	<b>SINGLE POLE</b>		
3'	4520-0007-008		5813-0023-000	410129002		
4'	4520-0007-009					
5'	4520-0007-010					
6'	4520-0007-011					
8'	4520-0007-012					
10'	4520-0007-013					

ST SERIES



DISCRIPTION	PART NUMBERS					
	120V	208V	240V	277V	347V	600V
<b>*ELEMENT (125 WATTS/FT)</b>						
<b>28" HEATER</b>	1802-2001-085	1802-2001-086	1802-2001-048	1802-2001-049	NA	NA
3'	1802-2001-087	1802-2001-088	1802-2001-054	1802-2001-055	1802-2001-220	NA
4'	1802-2001-089	1802-2001-090	1802-2001-060	1802-2001-061	1802-2001-230	NA
5'	1802-2001-091	1802-2001-092	1802-2001-066	1802-2001-067	1802-2001-240	1802-2001-241
6'	1802-2001-093	1802-2001-094	1802-2001-072	1802-2001-073	1802-2001-250	1802-2001-251
8'	NA	1802-2001-095	1802-2001-077	1802-2001-078	1802-2001-260	1802-2001-261
10'	NA	1802-2001-096	1802-2001-081	1802-2001-082	1802-2001-270	1802-2001-271
<b>*ELEMENT (188 WATTS/FT)</b>						
<b>28" HEATER</b>	1802-2001-005	1802-2001-002	1802-2001-001	1802-2001-000	NA	NA
3'	1802-2001-011	1802-2001-008	1802-2001-007	1802-2001-006	1802-2001-216	NA
4'	1802-2001-017	1802-2001-014	1802-2001-013	1802-2001-012	1802-2001-226	1802-2001-227
5'	1802-2001-023	1802-2001-020	1802-2001-019	1802-2001-018	1802-2001-236	1802-2001-237
6'	1802-2001-029	1802-2001-026	1802-2001-025	1802-2001-024	1802-2001-246	1802-2001-247
8'	NA	1802-2001-032	1802-2001-031	1802-2001-030	1802-2001-256	1802-2001-257
10'	NA	1802-2001-036	1802-2001-035	1802-2001-034	1802-2001-266	1802-2001-267
<b>*ELEMENT (250 WATTS/FT)</b>						
<b>28" HEATER</b>	1802-2001-004	1802-2001-003	1802-2001-002	1802-2001-001	1802-2001-202	NA
3'	1802-2001-010	1802-2001-009	1802-2001-008	1802-2001-007	1802-2001-214	NA
4'	1802-2001-016	1802-2001-015	1802-2001-014	1802-2001-013	1802-2001-224	1802-2001-225
5'	1802-2001-022	1802-2001-021	1802-2001-020	1802-2001-019	1802-2001-234	1802-2001-235
6'	1802-2001-028	1802-2001-027	1802-2001-026	1802-2001-025	1802-2001-244	1802-2001-245
8'	NA	1802-2001-033	1802-2001-032	1802-2001-031	1802-2001-254	1802-2001-255
10'	NA	1802-2001-037	1802-2001-036	1802-2001-035	1802-2001-264	1802-2001-265

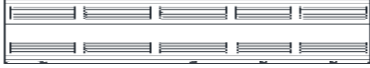

DISCRIPTION	PART NUMBERS					
	120V	208V	240V	277V	347V	600V
<b>LINEAR LIMIT</b>						
<b>28" HEATER</b>	4520-2018-001	4520-2018-001	4520-2018-001	4520-2018-001	4520-2018-001	4520-2018-001
3'	4520-2018-002	4520-2018-002	4520-2018-002	4520-2018-002	4520-2018-002	4520-2018-002
4'	4520-2018-003	4520-2018-003	4520-2018-003	4520-2018-003	4520-2018-003	4520-2018-003
5'	4520-2018-004	4520-2018-004	4520-2018-004	4520-2018-004	4520-2018-004	4520-2018-004
6'	4520-2018-005	4520-2018-005	4520-2018-005	4520-2018-005	4520-2018-005	4520-2018-005
8'	NA	4520-2018-006	4520-2018-006	4520-2018-006	4520-2018-006	4520-2018-006
10'	NA	4520-2018-007	4520-2018-007	4520-2018-007	4520-2018-007	4520-2018-007
<b>DISCONNECT SW.</b>	<b>THERMOSTAT</b>	<b>TRANSFORMER RELAY</b>		<b>J-BOX COVER</b>	<b>FRONT COVER</b>	
						
DS	<b>2-STAGE</b> 5813-0023-000 <b>SINGLE POLE</b> 5813-0024-000	<b>120V</b> 5018-11003-000 <b>208/240V</b> 5018-11003-001	<b>277V</b> 5018-11003-002 <b>347V</b> 5018-11003-003	<b>ALL MODELS</b> 1402-2250-000	1402-2251-000 1402-2251-001 1402-2251-002 1402-2251-003 1402-2251-004 1402-2251-005 1402-2251-006	28" 3' 4' 5' 6' 8' 10'

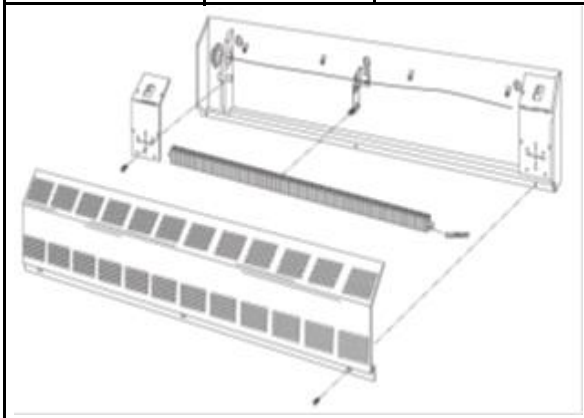



CSH, DSH, CPH, DPH, ADB, APH, & ASH SERIES







DISCRIPTION	PART NUMBERS					
	120V	208V	240V	277V	347V	600V
<b>*ELEMENT (125 WATTS/FT)</b>						
<b>28" HEATER</b>	1802-2001-085	1802-2001-086	1802-2001-048	1802-2001-049	NA	NA
3'	1802-2001-087	1802-2001-088	1802-2001-054	1802-2001-055	1802-2001-220	NA
4'	1802-2001-089	1802-2001-090	1802-2001-060	1802-2001-061	1802-2001-230	NA
5'	1802-2001-091	1802-2001-092	1802-2001-066	1802-2001-067	1802-2001-240	1802-2001-241
6'	1802-2001-093	1802-2001-094	1802-2001-072	1802-2001-073	1802-2001-250	1802-2001-251
8'	NA	1802-2001-095	1802-2001-077	1802-2001-078	1802-2001-260	1802-2001-261
10'	NA	1802-2001-096	1802-2001-081	1802-2001-082	1802-2001-270	1802-2001-271
<b>*ELEMENT (188 WATTS/FT)</b>						
<b>28" HEATER</b>	1802-2001-005	1802-2001-002	1802-2001-001	1802-2001-000	NA	NA
3'	1802-2001-011	1802-2001-008	1802-2001-007	1802-2001-006	1802-2001-216	NA
4'	1802-2001-017	1802-2001-014	1802-2001-013	1802-2001-012	1802-2001-226	1802-2001-227
5'	1802-2001-023	1802-2001-020	1802-2001-019	1802-2001-018	1802-2001-236	1802-2001-237
6'	1802-2001-029	1802-2001-026	1802-2001-025	1802-2001-024	1802-2001-246	1802-2001-247
8'	NA	1802-2001-032	1802-2001-031	1802-2001-030	1802-2001-256	1802-2001-257
10'	NA	1802-2001-036	1802-2001-035	1802-2001-034	1802-2001-266	1802-2001-267
<b>*ELEMENT (250 WATTS/FT)</b>						
<b>28" HEATER</b>	1802-2001-004	1802-2001-003	1802-2001-002	1802-2001-001	1802-2001-202	NA
3'	1802-2001-010	1802-2001-009	1802-2001-008	1802-2001-007	1802-2001-214	NA
4'	1802-2001-016	1802-2001-015	1802-2001-014	1802-2001-013	1802-2001-224	1802-2001-225
5'	1802-2001-022	1802-2001-021	1802-2001-020	1802-2001-019	1802-2001-234	1802-2001-235
6'	1802-2001-028	1802-2001-027	1802-2001-026	1802-2001-025	1802-2001-244	1802-2001-245
8'	NA	1802-2001-033	1802-2001-032	1802-2001-031	1802-2001-254	1802-2001-255
10'	NA	1802-2001-037	1802-2001-036	1802-2001-035	1802-2001-264	1802-2001-265

\* 1, 2 OR 3 ELEMENTS MAY BE REQUIRED. VOLTAGE AND WATTAGE ARE STAMPED ON END OF ELEMENTS. DIVIDE THE WATTAGE BY THE HEATER LENGTH (FEET) TO DETERMINE WATTS/FOOT OF ELEMENT. THEN USE THIS DATA TO DETERMINE PART NUMBER OF HEATING ELEMENT.

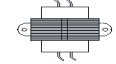

DISCRIPTION	PART NUMBERS					
	120V	208V	240V	277V	347V	600V
<b>LINEAR LIMIT</b>						
<b>28" HEATER</b>	4520-0007-007	4520-0007-007	4520-0007-007	4520-0007-007	4520-0007-007	4520-0007-007
3'	4520-0007-008	4520-0007-008	4520-0007-008	4520-0007-008	4520-0007-008	4520-0007-008
4'	4520-0007-009	4520-0007-009	4520-0007-009	4520-0007-009	4520-0007-009	4520-0007-009
5'	4520-0007-010	4520-0007-010	4520-0007-010	4520-0007-010	4520-0007-010	4520-0007-010
6'	4520-0007-011	4520-0007-011	4520-0007-011	4520-0007-011	4520-0007-011	4520-0007-011
8'	NA	4520-0007-012	4520-0007-012	4520-0007-012	4520-0007-012	4520-0007-012
10'	NA	4520-0007-013	4520-0007-013	4520-0007-013	4520-0007-013	4520-0007-013





DISCONNECT SW.	THERMOSTAT	TRANSFORMER RELAY		24V TRANSFORMER	PNEUMATIC CONTROL
					
410170001	2-STAGE 5813-0023-000 SINGLE POLE 5813-0024-000	120V 5018-11003-000 208/240V 5018-11003-001	277V 5018-11003-002 347V 5018-11003-003	208/240V PRIMARY 490026001 277V PRIMARY 490026002	ALL MODELS 5216-7027-005

CIRCUIT BREAKER	POWER RELAY	
		
2-POLE, 30A 1226-7009-013 2-POLE, 60A 1226-7009-010 3-POLE, 30A 1226-7009-005 3-POLE, 60A 1226-7009-002	24V 5018-2017-001 120V 5018-2021-001 208/240V 5018-2021-002	277V 410171003

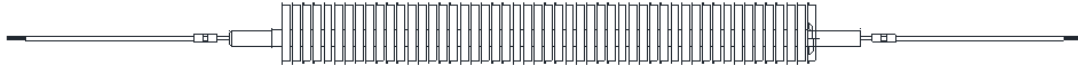

**DBSL SERIES**

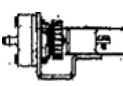

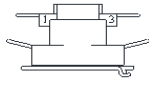
DISCRPTION	PART NUMBERS					
	120V	208V	240V	277V	347V	600V
<b>*ELEMENT (100 WATTS/FT)</b>						
<b>28" HEATER</b>	1802-2001-047	1802-2001-048	1802-2001-049	NA	NA	NA
3'	1802-2001-053	1802-2001-054	1802-2001-055	1802-2001-056	NA	NA
4'	1802-2001-059	1802-2001-060	1802-2001-061	1802-2001-062	1802-2001-232	NA
5'	1802-2001-065	1802-2001-066	1802-2001-067	1802-2001-068	1802-2001-242	NA
6'	1802-2001-071	1802-2001-072	1802-2001-073	1802-2001-074	1802-2001-252	1802-2001-253
8'	NA	1802-2001-077	1802-2001-078	1802-2001-079	1802-2001-262	1802-2001-263
10'	NA	1802-2001-081	1802-2001-082	1802-2001-083	1802-2001-272	1802-2001-273
<b>*ELEMENT (125 WATTS/FT)</b>						
<b>28" HEATER</b>	1802-2001-085	1802-2001-086	1802-2001-048	1802-2001-049	NA	NA
3'	1802-2001-087	1802-2001-088	1802-2001-054	1802-2001-055	1802-2001-220	NA
4'	1802-2001-089	1802-2001-090	1802-2001-060	1802-2001-061	1802-2001-230	NA
5'	1802-2001-091	1802-2001-092	1802-2001-066	1802-2001-067	1802-2001-240	1802-2001-241
6'	1802-2001-093	1802-2001-094	1802-2001-072	1802-2001-073	1802-2001-250	1802-2001-251
8'	NA	1802-2001-095	1802-2001-077	1802-2001-078	1802-2001-260	1802-2001-261
10'	NA	1802-2001-096	1802-2001-081	1802-2001-082	1802-2001-270	1802-2001-271
<b>*ELEMENT (150 WATTS/FT)</b>						
<b>28" HEATER</b>	1802-2001-051	1802-2001-001	1802-2001-000	1802-2001-052	NA	NA
3'	1802-2001-057	1802-2001-007	1802-2001-006	1802-2001-058	1802-2001-218	NA
4'	1802-2001-063	1802-2001-013	1802-2001-012	1802-2001-064	1802-2001-228	NA
5'	1802-2001-069	1802-2001-019	1802-2001-018	1802-2001-070	1802-2001-238	1802-2001-239
6'	1802-2001-075	1802-2001-025	1802-2001-024	1802-2001-076	1802-2001-248	1802-2001-249
8'	NA	1802-2001-031	1802-2001-030	1802-2001-080	1802-2001-258	1802-2001-259
10'	NA	1802-2001-035	1802-2001-034	1802-2001-084	1802-2001-268	1802-2001-269
<b>*ELEMENT (188 WATTS/FT)</b>						
<b>24" HEATER</b>	1802-2001-038	1802-2001-039	1802-2001-040	1802-2001-041	1802-2001-200	NA
<b>28"</b>	1802-2001-005	1802-2001-002	1802-2001-001	1802-2001-000	NA	NA
3'	1802-2001-011	1802-2001-008	1802-2001-007	1802-2001-006	1802-2001-216	NA
4'	1802-2001-017	1802-2001-014	1802-2001-013	1802-2001-012	1802-2001-226	1802-2001-227
5'	1802-2001-023	1802-2001-020	1802-2001-019	1802-2001-018	1802-2001-236	1802-2001-237
6'	1802-2001-029	1802-2001-026	1802-2001-025	1802-2001-024	1802-2001-246	1802-2001-247
8'	NA	1802-2001-032	1802-2001-031	1802-2001-030	1802-2001-256	1802-2001-257
10'	NA	1802-2001-036	1802-2001-035	1802-2001-034	1802-2001-266	1802-2001-267
<b>*ELEMENT (250 WATTS/FT)</b>						
<b>28" HEATER</b>	1802-2001-004	1802-2001-003	1802-2001-002	1802-2001-001	1802-2001-202	NA
3'	1802-2001-010	1802-2001-009	1802-2001-008	1802-2001-007	1802-2001-214	NA
4'	1802-2001-016	1802-2001-015	1802-2001-014	1802-2001-013	1802-2001-224	1802-2001-225
5'	1802-2001-022	1802-2001-021	1802-2001-020	1802-2001-019	1802-2001-234	1802-2001-235
6'	1802-2001-028	1802-2001-027	1802-2001-026	1802-2001-025	1802-2001-244	1802-2001-245
8'	NA	1802-2001-033	1802-2001-032	1802-2001-031	1802-2001-254	1802-2001-255
10'	NA	1802-2001-037	1802-2001-036	1802-2001-035	1802-2001-264	1802-2001-265
						
<b>LINEAR LIMIT</b>	<b>DISCONNECT SW.</b>		<b>THERMOSTAT</b>	<b>P.E. SWITCH</b>		
<b>28" HEATER</b>	4520-0007-007	410170001	<b>2-STAGE</b>	410172001		
3'	4520-0007-008		5813-0023-000			
4'	4520-0007-009		<b>SINGLE POLE</b>			
5'	4520-0007-010		5813-0024-000			
6'	4520-0007-011					
8'	4520-0007-012					
10'	4520-0007-013					
						
<b>TRANSFORMER</b>	<b>POWER RELAY</b>					
<b>120V</b>	<b>277V</b>	<b>24V</b>	<b>208/240V</b>			
5018-11003-000	5018-11003-002	410171001	410171003			
<b>208/240V</b>	<b>347V</b>	<b>120V</b>				
5018-11003-001	5018-11003-003	410171002				



## ARL SERIES

### ELEMENT

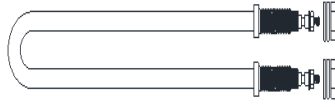
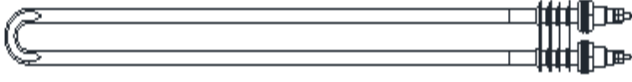

**1802-7076-001**

L1511B

**1802-7076-008**

L4521B

**HE45240**

L4521

**1802-7076-003**

L2021B

**1802-7076-010**

L4541B

**HE45480**

L4541

**1802-7076-005**

L2041B

**1802-7076-011**

L4561B

**HE20240**

L6023

**1802-7076-006**

L2061B

**1802-7076-009**

L4571B

**HE20480**

L6043

**1802-7076-004**

L2071B

**1802-7076-007**

L4581B

**HE45480**

L13543

**1802-7076-002**

L2081B

### RELECTOR

**891755004**

L1511B

**891755002**

L4581B

L4541B

L4521B



**1.5KW Portable**



**4.5KW Portable**

**BRM SERIES**

**ELEMENT**



<b>1802-7076-002</b> M2081B M6083B	<b>1802-7076-007</b> M4581B M13583B	<b>1802-2110-007</b> M6043A	<b>HE45208</b> M4581 M13583	<b>HE20208</b> M6083
<b>1802-7076-003</b> M2021B M6023B	<b>1802-7076-008</b> M4521B M13523B	<b>1802-2110-009</b> M4581A M13583A	<b>HE45240</b> M4521 M13523	<b>HE20240</b> M6023
<b>1802-7076-004</b> M6071B	<b>1802-7076-009</b> M13571B	<b>1802-2110-011</b> M4521A M13523A	<b>HE45480</b> M4541 M13543	<b>HE20480</b> M6043
<b>1802-7076-005</b> M2041B M6043B	<b>1802-7076-010</b> M4541B M13543B	<b>1802-2110-015</b> M4541A M13543A	<b>HE45600</b> M13563	<b>HE20600</b> M6063
<b>1802-7076-006</b> M2061B M6063B	<b>1802-7076-011</b> M4561B M13563B	<b>1802-2110-016</b> M13563A		

**NOTES**

6KW AND 13.5KW UNITS TAKE THREE ELEMENTS



**REFLECTOR**

<b>891755004</b> M6023B M6043B	<b>891755002</b> M13523B M13543B M4521B M4541B
--------------------------------------	--

## CRN SERIES

### ELEMENT





<b>1802-2115-001</b> N1011A	<b>1802-2115-013</b> N2001A	<b>1802-7077-001</b> N1011B	<b>1802-7077-009</b> N2001B
<b>1802-2115-004</b> N1021A	<b>1802-2115-015</b> N2021A	<b>1802-7077-003</b> N1021B	<b>1802-7077-010</b> N2021B
<b>1802-2115-006</b> N1031A	<b>1802-2115-017</b> N2031A	<b>1802-7077-002</b> N1081B	<b>1802-7077-012</b> N2031B
<b>1802-2115-005</b> N1071A	<b>1802-2115-016</b> N2071A	<b>1802-7077-004</b> N1511B	<b>1802-7077-011</b> N2071B
<b>1802-2115-008</b> N1501A	<b>1802-2115-018</b> N2501A	<b>1802-7077-006</b> N1521B	<b>1802-7077-013</b> N2501B
<b>1802-2115-007</b> N1511A	<b>1802-2115-020</b> N2521A	<b>1802-7077-008</b> N1531B	<b>1802-7077-014</b> N2521B
<b>1802-2115-010</b> N1521A	<b>1802-2115-022</b> N2531A	<b>1802-7077-007</b> N1571B	<b>1802-7077-016</b> N2531B
<b>1802-2115-012</b> N1531A	<b>1802-2115-021</b> N2571A	<b>1802-7077-005</b> N1581B	<b>1802-7077-015</b> N2571B
<b>1802-2115-011</b> N1571A			





**FRR & CMRR SERIES**

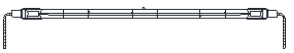

**ELEMENT**

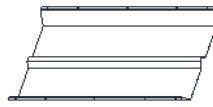
			
1802-0070-509 RR22012A	1802-2113-501 RR41512A	1802-2119-500 RR10512A	1802-2151-001 RR26164
1802-0070-550 RR35724A	1802-2113-516 RR53024A	RR11012A	1802-2151-000 RR26168

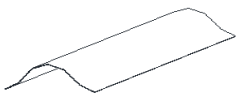
**REFLECTOR**



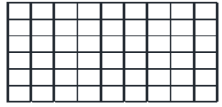
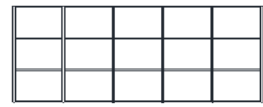

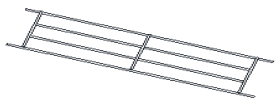
			
5007-2013-000 RR41512A	5007-2020-000 RR22012A	5007-2021-000 RR10512A	5007-2027-000 RR26164
5007-2013-001 RR53024A	5007-2020-001 RR35724A	RR11012A	RR26168

**WIRE GUARD**

			
2504-2014-000 RR35724A	2504-2015-000 RR22012A	2504-2016-000 RR41512A	2504-2017-000 RR10512A
		2504-2016-001 RR53024A	RR11012A
		2504-2016-002 RR26164	
		RR26168	

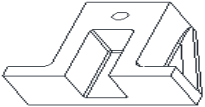
**CERAMIC BLOCK**

**SWITCH**





			
1224-0049-000 RR22012A	1224-2006-000 RR10512A	410024000 RR11012A	5216-11009-000 RR22012A
RR26164	RR11012A		RR35724A
RR26168			
RR35724A			

**ELEMENT BUSHING**

**CORD**

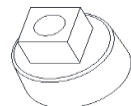



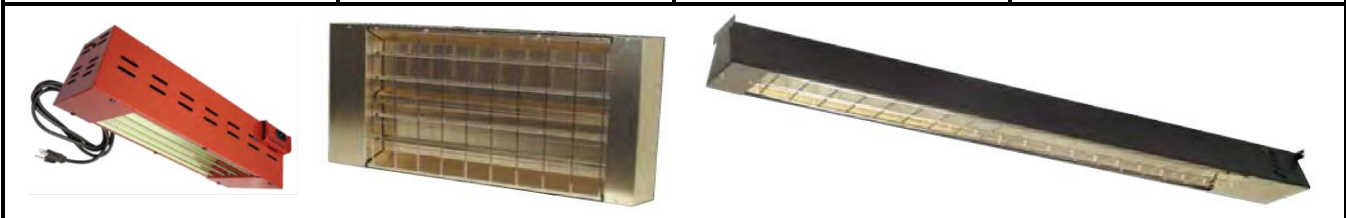

**CHAIN 4'**



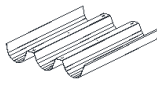

**"S" HOOKS**

			
1213-0070-000 RR22012A	1420-2016-000 RR10512A	1404-2000-001 RR10512A	2706-2000-000 RR10512A
RR26164	RR41512A	RR11012A	RR11012A
RR26168	1420-2016-008 RR11012A	RR22012A	RR22012A
RR35724A	1420-2016-002 RR22012A	RR35724A	RR35724A
	1420-2031-000 RR35724A	RR41512A	RR41512A
	1420-2016-001 RR53024A	RR53024A	RR53024A

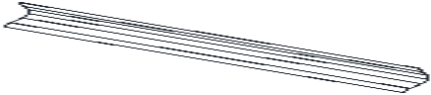

**FRP/FRS SERIES RADIANT HEATERS**

ELEMENTS					REFLECTOR			
								
PART NUMBER	TYPE	VOLTS	WATTS	USED WITH FIXTURE	5007-2003-000	5007-2003-001	5007-2003-002	
1802-0069-010 1802-2140-004 1802-0069-016 1802-0069-017 1802-2140-001 1802-0069-020	METAL SHEATH	208 240 277 347 480 600	850	RP22 RS22 RP32 RS32	RP223ASA RS223ASA	RP233ASA RS233ASA	RP243ASA RS243ASA	
1802-0070-001 1802-0070-002 1802-0070-003 NA	QUARTS TUBE	208 240 277 NA	1000		5007-2010-000 RP2235A RS2235A	5007-2010-001 RP2335A RS2335A	5007-2010-002 RP2435A RS2435A	
1802-2114-001 1802-2114-003 1802-2114-004 1802-2114-005 1802-2114-007 1802-2114-008	QUARTS LAMP	208 240 277 347 480 600	1600		5007-2011-000 RP226ASA RS226ASA	5007-2011-001 RP236ASA RS236ASA	5007-2011-002 RP246ASA RS246ASA	
1802-0069-006 1802-0069-005 1802-0069-004 1802-0069-023 1802-2140-002 1802-0069-026	METAL SHEATH	208 240 277 347 480 600	1500		5007-2009-000 RP2265A RP2295A RS2265A RS2295A	5007-2009-001 RP2365A RP2395A RS2365A RS2395A	5007-2009-002 RP2465A RP2495A RS2465A RS2495A	
1802-0070-008 1802-0070-005 1802-0070-006 1802-0070-017 1802-0070-019 1802-0070-020	QUARTS TUBE	208 240 277 347 480 600	1500					
1802-2114-009 1802-2114-011 1802-2114-012 1802-2114-013 1802-2114-015 1802-2114-016	QUARTS LAMP	208 240 277 347 480 600	2500		5007-2008-000 RP323ASA RS323ASA	5007-2008-001 RP333ASA RS333ASA	5007-2008-002 RP343ASA RS343ASA	
1802-0069-009 1802-0069-008 1802-0069-007 1802-0069-029 1802-2140-003 1802-0069-032	METAL SHEATH	208 240 277 347 480 600	2000	5007-2017-000 RP3235A RS3235A	5007-2017-001 RP3335A RS3335A	5007-2017-002 RP3435A RS3435A		
1802-0070-030 1802-0070-032 1802-0070-033 1802-0070-034 1802-0070-036 1802-0070-037	QUARTS TUBE	208 240 277 347 480 600	2000	5007-2018-000 RP326ASA RP3295A RS326ASA RS3295A	5007-2018-001 RP336ASA RP3395A RS336ASA RS3395A	5007-2018-002 RP346ASA RP3495A RS346ASA RS3495A		
1802-2114-021 1802-2114-023 1802-2114-024	QUARTS LAMP	347 480 600	3650	5007-2016-000 RP3265A RP3295A RS3265A RS3295A	5007-2016-001 RP3365A RP3395A RS3365A RS3395A	5007-2016-002 RP3465A RP3495A RS3465A RS3495A		
								
					ELEMENT TERM BUSH*		TERMINAL BLOCK*	
					ALL MODELS 1213-0070-000		ALL MODELS 1224-0049-000	
					NOTES			
					* FOUR REQUIRED ON 2 ELEMENT AND SIX FOR 3 ELEMENT FIXTURES			
								

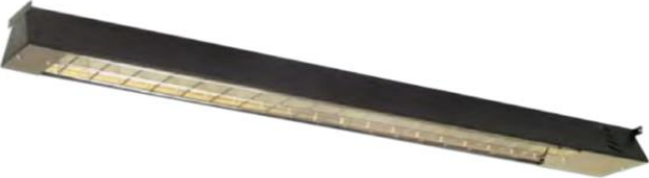
HRK SERIES			
ELEMENT		REFLECTOR	
			
1802-2113-501 RK41512A	1802-2113-515 RK53020A	5007-2013-000 RK41512A RK42020A RK42024A RK42027A RK42034A RK42048A RK42060A	5007-2013-001 RK53020A RK53024A RK53027A RK53034A RK53048A RK53060A
1802-2113-509 RK42020A	1802-2113-516 RK53024A		
1802-2113-510 RK42024A	1802-2113-517 RK53027A		
1802-2113-511 RK42027A	1802-2113-518 RK53034A		
1802-2113-512 RK42034A	1802-2113-519 RK53048A		
1802-2113-513 RK42048A	1802-2113-520 RK53060A		
1802-2113-514 RK42060A			
CHAIN 2 REQ.	"S" HOOK 4 REQ.		
			
1404-2000-001 ALL MODELS	2706-2000-000 ALL MODELS	1402-2275-000 ALL MODELS	1402-2275-001 ALL MODELS
			





QHRA & QVRC SERIES		
ELEMENT	QHRA66	QHRA11
PICTURE NOT AVAILABLE		
<b>IFCQL115A</b> HRA11115W HRARC11115W	<b>IFCQL420A</b> HRA66420BA VRC4420SG VRC4440DWG VRC4440DTG	
2 ELEMENTS REQ ON 4000 WATT MODELS		
QVRC4440DWG	QVRC4440DTG	QVRC4420SG
		

## RCC COVE HEATERS (C & D SERIES)

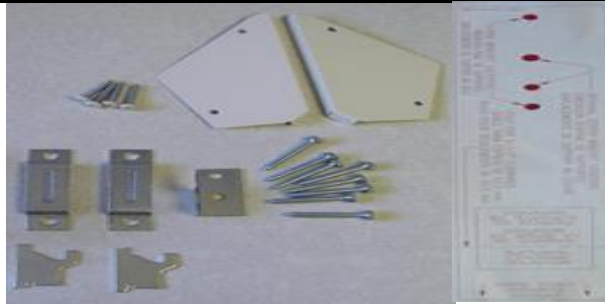
### PARTS KIT\*

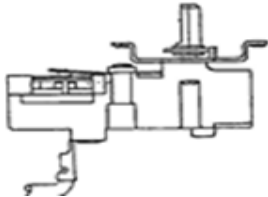

<b>WHITE</b> 3303-2032-000	<b>DOVE GRAY</b> 3303-2032-001	<b>DESERT TAN</b> 3303-2032-002
<b>CENTER SUP BRACKET**</b>	<b>THERMOSTAT</b>	<b>THERMOSTAT KNOB</b>
		
<b>ALL MODELS</b> 1215-2309-000	<b>ALL MODELS</b> 410129001	<b>ALL MODELS</b> 3301-2020-006













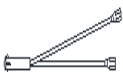

**NOTES**

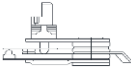

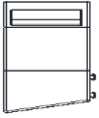

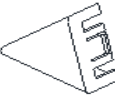





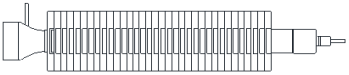
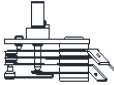

**REPLACE HEATER IF FRONT COVER OR ELEMENT IS NEEDED**

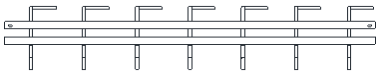
**\* PARTS KIT INCLUDES MOUNTING BRACKETS, MOUNTING TEMPLATE, AND END CAPS**



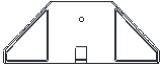

**\*\* 1500 & 1800 WATT MODELS TAKE TWO CENTER SUPPORT BRACKETS**



FBE SERIES					
ELEMENT		SWITCH			LIGHT
					
1802-2087-000 FBE15002C FBE15002CA		5216-2007-000 FBE1000A FBE1200 FBE1250A	5216-2010-000 FBE15002 FBE15002A	5216-2027-000 FBE15002B FBE15002C FBE15002CA	3510-2008-001 FBE1504C
LIMIT	THERMOSTAT	KNOB		FACE PLATE	
					
4520-2011-004 FBE1500C FBE15002A FBE15002B FBE15002C FBE15002CA	5813-2058-001 FBE1200 FBE1200C FBE1500C FBE15002B FBE15002C FBE15002CA FBE1504C	3301-2017-000 FBE1000A FBE1250A FBE15002 FBE15002A	3301-2011-003 FBE1200 FBE1200C FBE1500C FBE15002B FBE15002C FBE15002CA FBE1504C	1402-2122-139 FBE1000A	1402-2122-136 FBE15002
				1402-2122-141 FBE1200	1402-2122-138 FBE15002A
				1402-2122-125 FBE1200C	1402-2122-142 FBE15002B
				1402-2122-140 FBE1250A	1402-2122-626 FBE15002CA
END CAP RIGHT	END CAP LEFT	LEG RIGHT	LEG LEFT	CORD	CONTROL COVER
					
1800-2047-001 FBE1200C FBE1500C FBE15002C FBE15002CA FBE1504C	1800-2048-001 FBE1200C FBE1500C FBE15002C FBE15002CA FBE1504C	3507-2004-001 FBE1200C FBE1500C FBE15002C FBE15002CA FBE1504C	3507-2005-001 FBE1200C FBE1500C FBE15002C FBE15002CA FBE1504C	1420-2027-001 FBE15002C 1420-11013-000 FBE15002CA	1402-2243-001 FBE15002B FBE15002C FBE15002CA
					

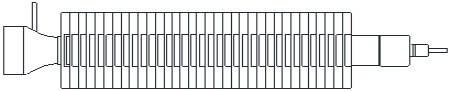
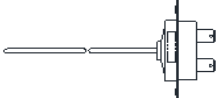
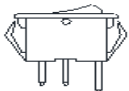
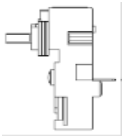
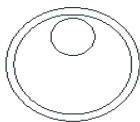

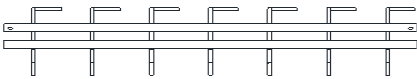



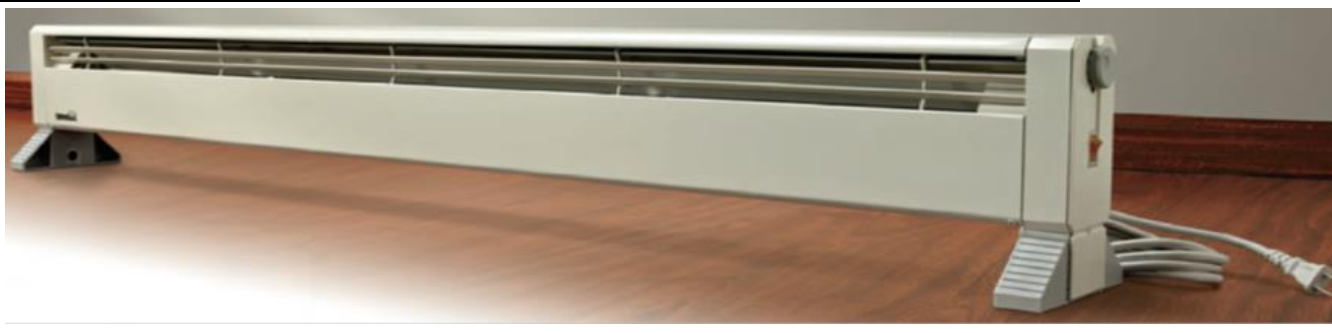

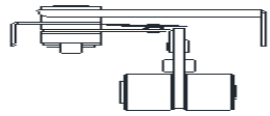

LFP SERIES					
ELEMENT		THERMOSTAT		LIMIT	
					
1802-2067-023 LFP6152D LFP6152E LFP6152EA	1802-2067-001 LFP675D	5813-2019-000 LFP6152 LFP6152D LFP6152E LFP6152EA	5813-2001-000 LFP675 LFP675D	410163004 LFP6152 LFP6152D LFP6152E LFP6152EA	4520-2010-001 LFP675 LFP675D
GRILLE	LIGHT	DIODE BRIDGE	FRONT COVER	CORD	
					
2501-2012-015 LFP6152 LFP6152D LFP6152E LFP6152EA	2501-2012-013 LFP675 LFP675D	3510-2006-000 LFP6152 LFP6152D LFP6152E LFP6152EA	DBKIT LFP6152 LFP6152D LFP6152E LFP6152EA	1402-2066-609 LFP6152EA	1420-11013-000 LFP6152D LFP6152E LFP6152EA
KNOB	LEG	SWITCH	END CAP		
					
3301-2011-001 LFP6152 LFP6152D LFP6152E LFP6152EA LFP675 LFP675D	3507-2003-000 LFP6152 LFP6152D LFP6152E LFP6152EA LFP675 LFP675D	5216-2007-000 LFP6152 LFP6152D LFP6152E LFP6152EA LFP675 LFP675D	1800-2027-000 LFP6152 LFP6152D LFP6152E LFP6152EA LFP675 LFP675D		

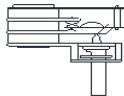
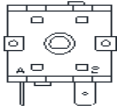
## FHP SERIES



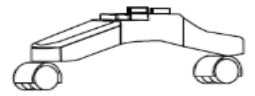

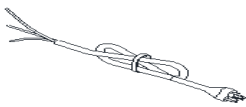

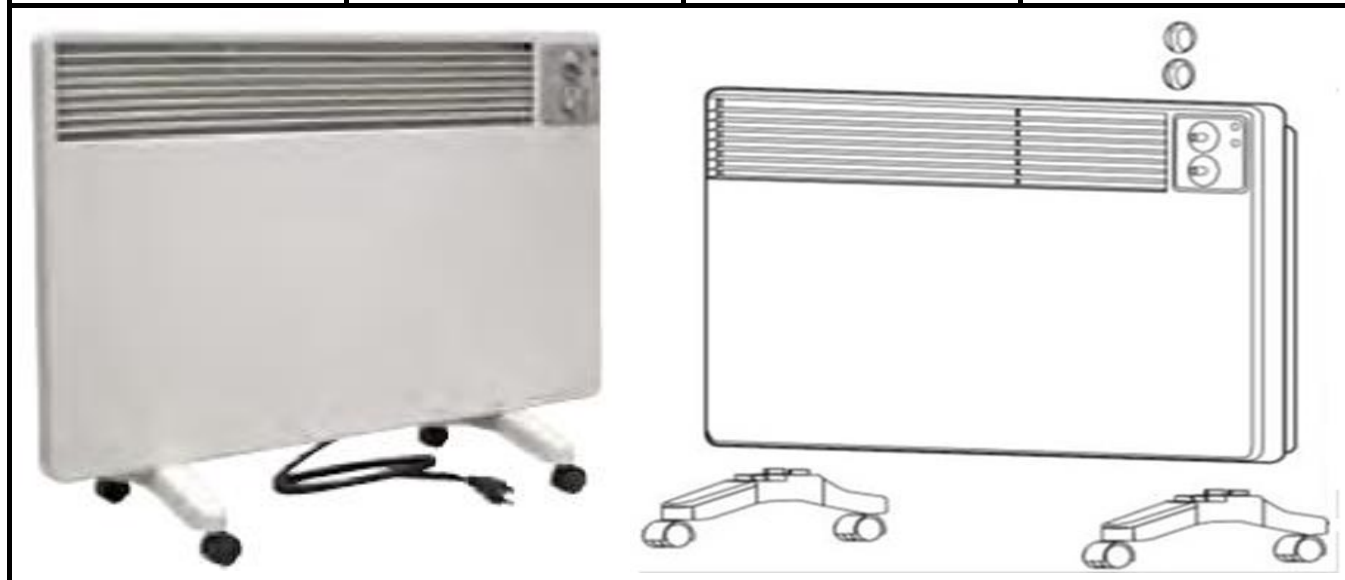

ELEMENT		LIMIT		SWITCH
				
<b>1802-2067-001</b> FHP0750KCT FHP0750KCTA FHP0750T FHP0750TA	<b>1802-2067-023</b> FHP1500KCT FHP1500KCTA FHP1500T FHP1500TA	<b>4520-0011-000</b> FHP0750KCT FHP0750KCTA FHP0750T FHP0750TA	<b>410163004</b> FHP1500KCT FHP1500KCTA FHP1500T FHP1500TA	<b>5216-2007-000</b> FHP0750KCT FHP0750KCTA FHP0750T FHP0750TA FHP1500KCT FHP1500KCTA FHP1500T FHP1500TA
THERMOSTAT	KNOB	FRONT COVER		END CAP
				
<b>5813-11012-000</b> FHP0750KCT FHP0750KCTA FHP0750T FHP0750TA FHP1500KCT FHP1500KCTA FHP1500T FHP1500TA	<b>3301-2011-005</b> FHP0750KCT FHP0750KCTA FHP0750T FHP0750TA FHP1500KCT FHP1500KCTA FHP1500T FHP1500TA	<b>1402-2066-607</b> FHP0750KCT FHP0750KCTA FHP0750T FHP0750TA	<b>1402-2066-609</b> FHP1500KCT FHP1500KCTA FHP1500T FHP1500TA	<b>1800-2027-000</b> FHP0750KCT FHP0750KCTA FHP0750T FHP0750TA FHP1500KCT FHP1500KCTA FHP1500T FHP1500TA
GRILLE		LEGS (2 REQ)	CORD	
				
<b>2501-2012-013</b> FHP0750KCT FHP0750KCTA FHP0750T FHP0750TA	<b>2501-2012-015</b> FHP1500KCT FHP1500KCTA FHP1500T FHP1500TA	<b>3507-2003-000</b> FHP0750KCT FHP0750KCTA FHP0750T FHP0750TA FHP1500KCT FHP1500KCTA FHP1500T FHP1500TA	<b>1420-11013-000</b> FHP0750KCT FHP0750KCTA FHP0750T FHP0750TA FHP1500KCT FHP1500KCTA FHP1500T FHP1500TA	

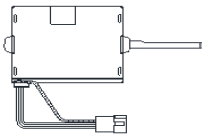
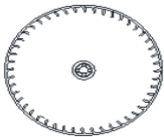

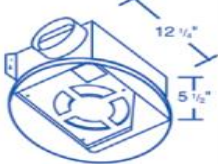
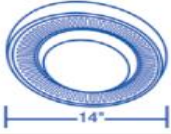

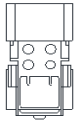
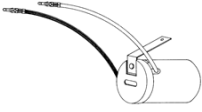
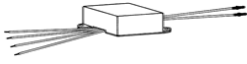

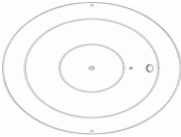
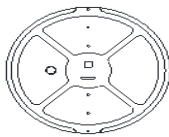

## WPC SERIES

ELEMENT	TIP OVER SW.	LIMIT	THERMOSTAT
			
<b>1802-10822-000</b> WPC1500A	<b>5216-11004-000</b> WPC1500A	<b>410122002</b> WPC1500A	<b>5813-2092-001</b> WPC1500A
4 POSITION SW.	PORT SWITCH	LIGHT RED	PILOT LIGHT AMBER
			
<b>5216-2071-000</b> WPC1500A	<b>5216-2073-000</b> WPC1500A	<b>3510-2021-002</b> WPC1500A	<b>3510-11518-000</b> WPC1500A
WHEEL KIT (2 REQ)	HOLE PLUG (2 REQ)	CORD	KNOB (2 REQ)
			
<b>1205-1035-000</b> WPC1500A	<b>4506-2022-000</b> WPC1500A	<b>1420-2029-009</b> WPC1500A	<b>3301-2058-000</b> WPC1500A

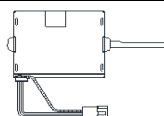
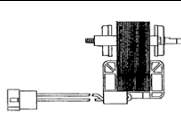

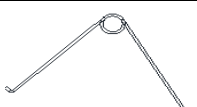

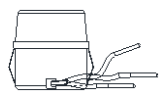
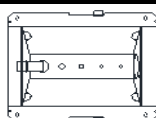

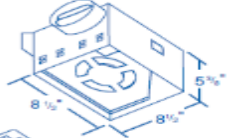
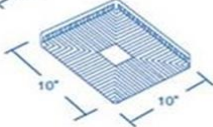
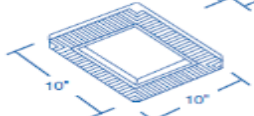





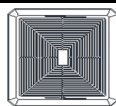



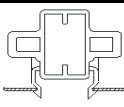
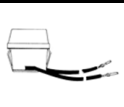

1001 SERIES				
MOTOR	IMPELLER	GRILLE		LENS
				
<b>7163-9763</b> 1001 1001F 1001BR	<b>8710-8023</b> 1001 1001F 1001BR	<b>357-114-W</b> 1001 1001F	<b>357-114-OP</b> 1001BR	<b>460-011-W</b> 1001 1001F 1001BR
LAMP HOLDER			BALLAST ASY	  
				
<b>3519-11005-000</b> 1001	<b>8695-8098</b> 1001F	<b>8695-8101</b> 1001BR	<b>6104-8020</b> 1001F	
DUCT ADAPTER	REFLECTOR ASY		GRILLE SPRING (2 REQ)	
				
<b>991-613</b> 1001 1001F 1001BR	<b>8826-8044</b> 1001 1001BR	<b>630-063</b> 1001F	<b>733-218</b> 1001 1001F 1001BR	

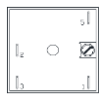

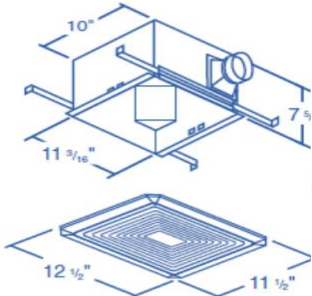

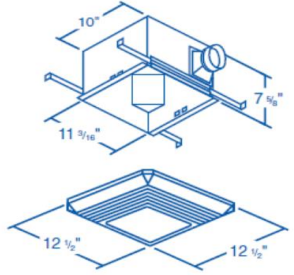

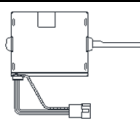
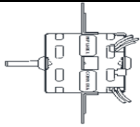
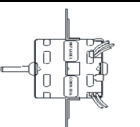
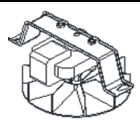
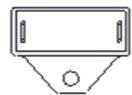
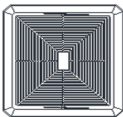
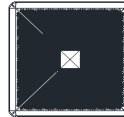
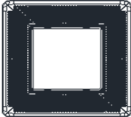
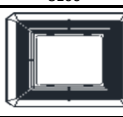

## 6000 SERIES

MOTOR				GRILLE	
					
<b>7163-9763</b> 6100 6100L 6100RL		<b>7173-0174</b> 6080 6080L 6080RL		<b>991-688</b> 6060 6080 6100	
<b>8767-8238</b> 6060 6060L 6060RL		<b>991-689</b> 6060L 6080L 6100L		<b>1016-0077-000</b> 6060RL 6080RL 6100RL	
IMPELLER		GRILLE SPRING (2 REQ)		DUCT ADAPTER	
					
<b>8710-8021</b> 6060 6060L 6060RL		<b>8710-8023</b> 6080 6080L 6080RL 6100 6100L 6100RL		<b>733-218</b> 6060 6060L 6060RL 6080 6080L	
<b>991-613</b> 6060 6060L 6060RL 6080 6080L		6080RL 6100 6100L 6100RL			
LENS		LAMP HOLDER		REFLECTOR ASY	
					
<b>8738-8017</b> 6060L 6080L 6100L		<b>3508-2003-000</b> 6060RL 6080RL 6100RL		<b>3519-0004-000</b> 6060L 6060RL 6080L 6080RL 6100L 6100RL	
<b>991-591</b> 6060L 6060RL 6080L 6080RL 6100L 6100RL					
					
					

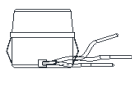
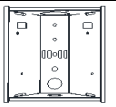
**7100 SERIES**

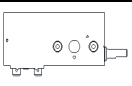

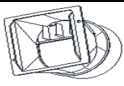



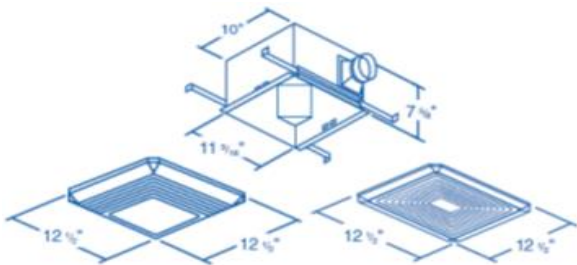

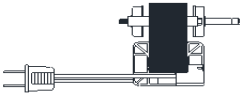
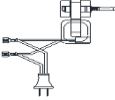

MOTOR		IMPELLER		GRILLE		GRILLE SPRINGS (2 REQ)	
							
<b>GM7100</b> 7100 7100A 7100FL 7100FLH 7100H 7100HA 7100L 7100LA 7100LH	<b>GM7150</b> 7150 7150A 7150FL 7150FLH 7150H 7150HA 7150L 7150LA 7150LH	<b>8710-8017</b> 7100 7100A 7100FL 7100FLH 7100H 7100HA 7100L 7100LA 7100LH		<b>7150</b> 7150A 7150FL 7150FLH 7150H 7150HA 7150L 7150LA 7150LH	<b>991-611-W</b> 7100 7100A 7100H 7100HA 7150 7150HA	<b>991-608-W</b> 7100FL 7100FLH 7100L 7100LA 7100LH 7150FL 7150FLH 7150H 7150L 7150LA 7150LH	<b>733-218</b> ALL MODELS
<b>DUCT ADAPTER</b>		<b>LENS</b>		<b>LAMP HOLDER</b>			
							
<b>1016-0091-000</b> 7100A 7100LA 7150A 7150LA	<b>991-613</b> 7100 7100FL 7100FLH 7100H 7100HA 7100L 7100LH	<b>7150</b> 7150FL 7150FLH 7150H 7150HA 7150L 7150LH	<b>8738-8017</b> 7100FL 7100FLH 7100L 7100LH 7150FL 7150FLH 7150L 7150LH	<b>3508-2003-000</b> 7100LA 7150LA	<b>8695-8097</b> 7100FL 7100FLH 7150FL 7150FLH	<b>8504-8476</b> 7100L 7100LA 7100LH 7150L 7150LA 7150LH	
<b>REFLECTOR ASY</b>		<b>BALLAST ASY</b>		<b>TIMER</b>	<b>HUMIDISTAT</b>	<b>NOTES</b>	
						GM7100 AND GM7150 MOTOR/BLOWER ASSY INCLUDES IMPELLER AND MOTOR BRACKET	
<b>8826-8040</b> 7100L 7100LA 7100LH 7150L 7150LA 7150LH	<b>5007-2023-000</b> 7100FL 7100FLH 7150FL 7150FLH	<b>1228-2002-000</b> 7100FL 7100FLH 7150FL 7150FLH	<b>1414-2031-000</b> 7100FLH 7100HA 7150FLH 7150HA	<b>1414-2032-000</b> 7100FLH 7100HA 7150FLH 7150HA			
							

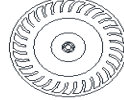

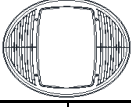
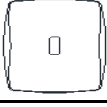
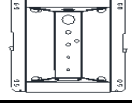
8000 SERIES						
MOTOR						
						
<b>3900-2066-000</b> 8090 8090A 8090L 8090LA	<b>3900-2091-000</b> 8060ES 8100ES 8100FLA 8060ESA 8100ESA 8100FLE 8060FL 8100ESH 8100FLH 8060FLA 8100ESHA 8100FLHA 8060FLE 8100FL 8100FLHE			<b>3900-2092-000</b> 8080ES 8140ES 8080FL 8140EAS 8080FLA 8140FL 8080FLE 8140FLA 8140A 8140FLE 8140LA	<b>GM7100</b> 8100 8100A 8100L 8100LA	
CAPACITOR			GRILLE			
						
<b>1432-2007-000</b> 8060ES 8100ES 8100FLHE 8060ESA 8100ESA 8140A 8060FL 8100ESH 8140ES 8060FLA 8100ESHA 8140EAS 8060FLE 8100FL 8140FL 8080ES 8100FLA 8140FLA 8080FL 8100FLE 8140FLE 8080FLA 8100FLH 8140LA 8080FLE 8100FLHA			<b>991-611-W</b> 8090 8100 	<b>1016-0137-000</b> 8060ES 8060FLA 8060ESA 8060FLE 8080ES 8080FL 8090A 8080FLA 8100A 8080FLA 8100ES 8080FLE 8100ESA 8090LA 8100ESH 8100FL 8100ESHA 8100FLA 8140A 8100FLE 8140ES 8100FLH 8140EAS 8100FLHA	<b>1016-0136-000</b> 8060FL 8100FLHE 8060FLA 8100LA 8060FLE 8140FL 8080FL 8140FLA 8080FLA 8140FLE 8080FLE 8140LA 8090LA 8100FL 8100FLA 8100FLE 8100FLH 8100FLHA	
LENS		LAMP HOLDER		REFLECTOR ASY	TIMER	
						
<b>8738-8017</b> 8060FL 8100FLE 8060FLA 8100FLH 8060FLE 8100FLHA 8080FL 8100FLHE 8080FLA 8100L 8080FLE 8100LA 8090L 8140FL 8090LA 8140FLA 8100FL 8140FLE 8100FLA 8140LA		<b>3519-0004-000</b> 8060FL 	<b>3519-11001-000</b> 8060FLA 8060FLE 8080FLA 8080FLE 8100FLA 8100FLE 8100FLHA 8100FLHE 8140FLA 8140FLE 8140LA	<b>8695-8097</b> 8080FL 8100FL 8100FLH 8140FL	<b>8826-8040</b> 8060FL 8090L 8090LA 8100L 8100LA <b>5007-2023-000</b> 8080FL 8100FL 8100FLH 8140FL	<b>1414-2031-000</b> 8100ESH 8100ESHA 8100FLH 8100FLHA 8100FLHE
HUMIDISTAT	GRILLE SPRING (2 REQ)	DUCT ADAPTER	IMPELLER	BALLAST ASY	NOTES	
					GM7100 IS MOTOR/BLOWER ASSY INCLUDES IMPELLER AND MOTOR BRACKET	
<b>1414-2032-000</b> 8100ESH 8100ESHA 8100FLH 8100FLHA 8100FLHE	<b>733-218</b> ALL MODELS	<b>1016-0091-000</b> ALL MODELS	<b>8710-8017</b> ALL MODELS	<b>1228-2002-000</b> 8060FL 8060FLA 8060FLE 8080FL 8080FLA 8080FLE 8100FL 8100FLH 8140FL		





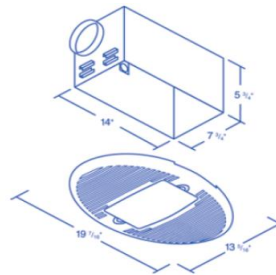

**COMBINATION FANS MM698 & MM728NL**

MOTOR (EXHAUST)		MOTOR (HEAT)	FAN	IMPELLER		DUCT ADAPTER
						
3900-2049-000 MM728 MM728NL	8767-8130 MM698 MM698A MM698F MM698AF MM698WC MM698WCA	3900-2076-000 MM698 MM698A MM698F MM698AF MM698WC MM698WCA MM728 MM728NL	8528-8052 MM698 MM698A MM698F MM698AF MM698WC MM698WCA MM728 MM728NL	8710-8016 MM698 MM698A MM698F MM698AF MM698WC MM698WCA	313-076 MM728 MM728NL	991-614 MM698 MM698A MM698F MM698AF MM698WC MM698WCA MM728 MM728NL
GRILLE		LENS	REFLECTOR ASY			ELEMENT
						
1016-0080-000 MM698 MM698A MM698WC MM698WCA MM728 MM728NL	1016-0082-000 MM698F MM698AF	3508-2002-000 MM698 MM698A MM698F MM698AF MM698WC MM698WCA MM728 MM728NL	630-065 MM698 MM698A MM698WC MM698WCA MM728	630-068 MM698F MM698AF	5007-2024-000 MM728NL	991-497 MM698 MM698A MM698F MM698AF MM698WC MM698WCA MM728 MM728NL
LAMP HOLDER			WALL SWITCH		BALLAST ASY	
						
8695-8097 MM698F MM698AF	8504-8476 MM728NL	398-051 MM698 MM698A MM698WC MM698WCA MM728	8587-0003A MM698WC MM698WCA	8587-8229 MM728 MM728NL	1228-2002-000 MM698F MM698AF	

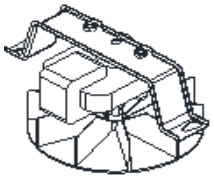
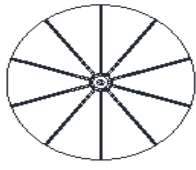
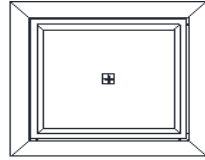
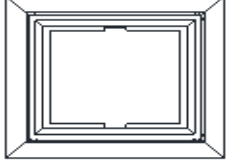

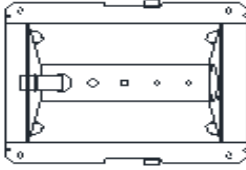



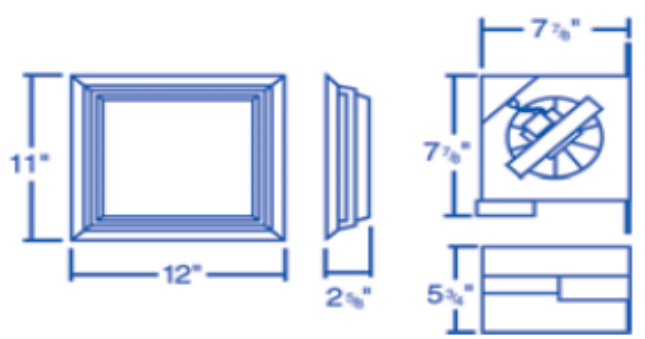
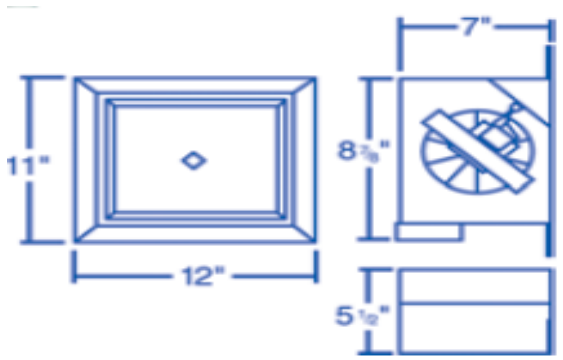



## DUCTLESS BATH FANS 645 & 646

MOTOR	IMPELLER	GRILLE	
			
<b>GM50</b> 645 646	<b>8710-8016</b> 645 646	<b>991-337-W</b> 645	<b>357-089-W</b> 646
LAMP HOLDER	REFLECTOR ASY	LENS	FILTER
			PICTURE NOT AVAILABLE
<b>398-051</b> 646	<b>8826-8039</b> 646	<b>460-010-W</b> 646	<b>8663-8052</b> 645 646



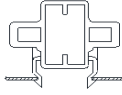
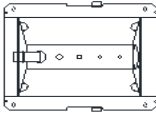



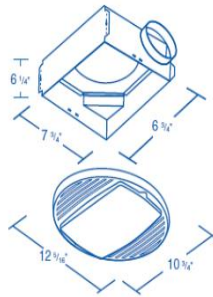

**ECONOMY BATH FAN/LIGHT MM664IC, MM667IC & MM667ICF**

MOTOR		IMPELLER	GRILLE	LENS	DUCT ADAPTER
					
<b>GM50</b> MM664IC	<b>GM70</b> MM667IC MM667ICF	<b>8710-8016</b> MM664IC MM667IC MM667ICF	<b>357-106-W</b> MM664IC MM667IC MM667ICF	<b>3508-2002-000</b> MM664IC MM667IC MM667ICF	<b>991-615</b> MM664IC MM667IC MM667ICF
LAMP HOLDER		REFLECTOR ASY		BALLAST ASY	NOTES
					GM50 & GM70 MOTOR/BLOWER ASSY INCLUDES IMPELLER AND MOTOR BRACKET
<b>398-051</b> MM664IC MM667IC	<b>8695-8097</b> MM667ICF	<b>991-600</b> MM664IC MM667IC	<b>630-067</b> MM667ICF	<b>1228-2002-000</b> MM667ICF	

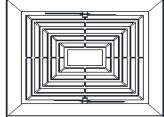
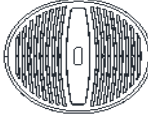
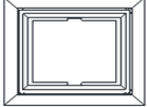

**ECONOMY QUICK MOUNT SERIES A647, A664IC, MM647, MM648, AND MM748**

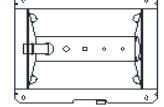
MOTOR		IMPELLER	DUCT ADAPTER		LAMP HOLDER
					
<b>GM50</b> A647 A647A A647B A664IC MM647 MM647B MM648	<b>GM70</b> MM748 MM748H	<b>8710-8016</b> A647 A647A A647B A664IC MM647 MM647B MM648 MM748 MM748H	<b>991-630</b> A647 A647A A647B MM647 MM647B MM648	<b>991-615</b> A664IC MM748 MM748H	<b>398-051</b> A664IC
GRILLE		LENS	GRILLE SPRING (2 REQ)	REFLECTOR ASY	
					
<b>991-616-W</b> A647 A647A A647B	<b>2501-2053-000</b> MM647 MM647B MM648 MM748 MM748H	<b>357-116-W</b> A664IC	<b>460-010-W</b> A664IC	<b>733-218</b> A647 A647A A647B MM647 MM647B MM648 MM748 MM748H	<b>8826-8039</b> A664IC





**NOTE: GM50 & GM70 INCLUDE MOTOR/IMPELLER AND BRACKET**

## FIRE RATED VENTILATORS

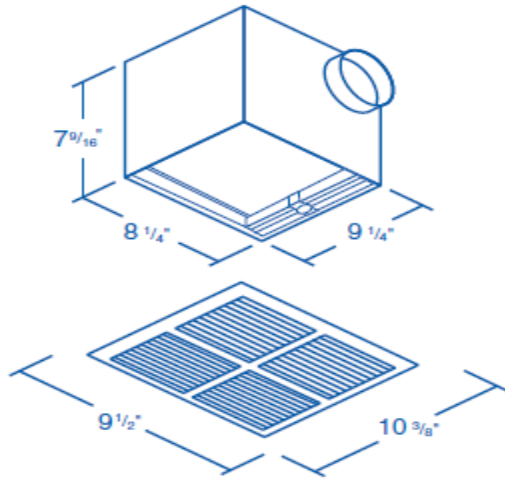



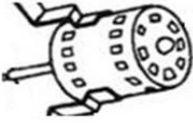
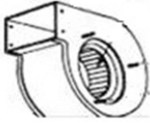
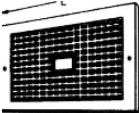





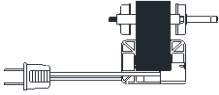
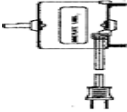

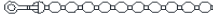
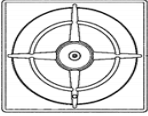
MOTOR/BLOWER ASY			LIMIT	GRILLE
PICTURE NOT AVAILABLE			PICTURE NOT AVAILABLE	PICTURE NOT AVAILABLE
<b>Z650FRD</b> 650FRD	<b>Z680FRD</b> 680FRD	<b>Z610FRD</b> 610FRD	<b>FL165</b> 650FRD 680FRD 610FRD	<b>2501-2064-000</b> 650FRD 680FRD 610FRD

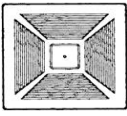

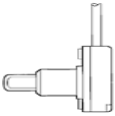
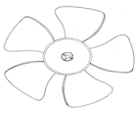
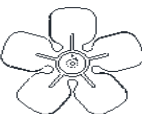
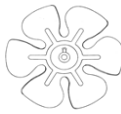
## SUPER Q VENTILATORS





MOTOR		IMPELLER		
				
56343-0 CV6	56346-0 CV10	56334-0 CV6	56335-0 CV8 CV81 CV101 CV12	56367-0 CV10
56344-0 CV8	56347-0 CV101			
56345-0 CV81	56350-0 CV12			
GRILLE				GRILLE SPRING (2 REQ)
				<p style="font-size: 1.2em; margin: 0;">PICTURE NOT AVAILABLE</p>
55130-1 CV6	55131-1 CV8 CV81	55132-1 CV10	55133-1 CV101 CV12	56327-0 CV6 CV8 CV81 CV10 CV101 CV12
				

**GENERAL HOME / KITCHEN FANS**



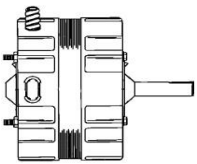
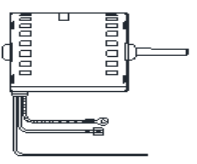
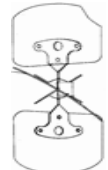
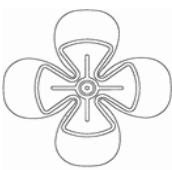
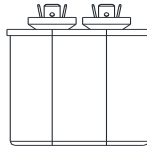
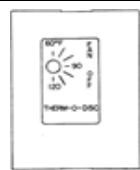
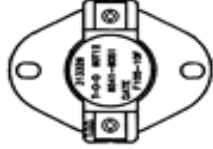





MOTOR		GRILLE KNOB		CHAIN	
					
8767-8232 898L 899L	8767-8233 790L 760L	7163-9672 1047 1080	6112-8023 790L	0899-0008 898L 899L 1047 760L 1080	
GRILLE				CONTROL KNOB	SWITCH
					
8683-8323 1047 8683-8308 1080	8683-8062 790L*	8683-8295 790L** 898L 760L	8683-8320 899L	3301-2039-000 790L	0810-0288 899L 1047
FAN				NOTES	
				* FRONT GRILLE 790L ** REAR GRILLE 790L	
8528-8026 898L 899L	8528-8152 1047 1080	8528-8075 790L	8528-0039 760L		
					
790L	898L	899L			
					
1047	760L	1080			

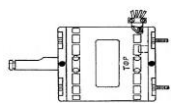
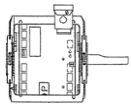
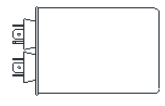
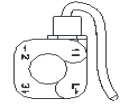

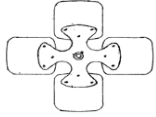
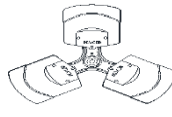
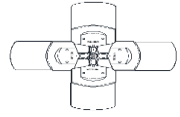
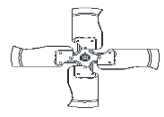
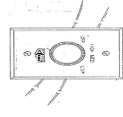

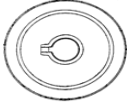
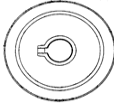
## ATTIC VENTILATORS

MOTOR		FAN BLADE	
			
<b>8767-8241</b> RV16 GV16	<b>7163-9739</b> ASRV14 AGV14	<b>8528-8041</b> RV16 <b>8528-8118</b> GV16	<b>8528-8142</b> ASRV14 AGV14
CAPACITOR	THERMOSTAT		
			
<b>6100-8036</b> RV16 GV16	<b>1230-8192</b> RV16 GV16	<b>8541-8051</b> ASRV14 AGV14	
			
<b>RV16</b>	<b>ASRV14</b>	<b>AGV14 &amp; GV16</b>	

## WHOLE HOUSE FANS

MOTOR		CAPACITOR		SWITCH	SHUTTER
					
7126-3441 A20DD	7126-3436 2438	1432-0002-001 A20DD	6100-8039 A24DD	5216-2059-000 A20DD	8862-8039 A20DD
7126-3438 A24DD	7126-3439 3038R 7126-3440 3638R	1432-0002-004 2438 3038R	6100-8026 3638R		
FAN BLADE				CONTROL ASY	SHAFT
					
8528-8069 A20DD	8528-8150 A24DD 8528-8147 2438	8528-8148 3038R	8528-8149 3638R	8587-8129 A24DD 2438 3038R 8587-8133 3638R	8856-8014 2438 3038R 3638R
MOTOR SHEAVE	FAN SHEAVE		V-BELT	 <b>2438, 3038R &amp; 3638R</b>	
			PICTURE NOT AVAILABLE		
8944-8024 2438 8944-8023 3038R 8944-8022 3638R	8944-8025 2438	8944-8026 3038R 8944-8027 3638R	9707-8053 2438 9707-8054 3038R 9707-8055 3638R		
					
<b>A20DD</b>		<b>A24DD</b>			

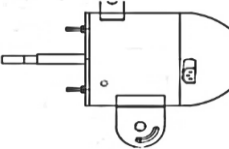
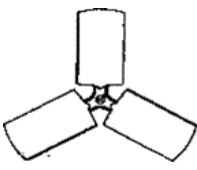
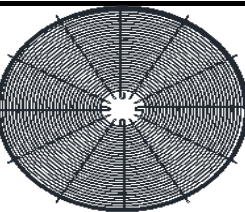

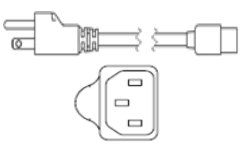



**SAFETY YELLOW HIGH PERFORMANCE AIR CIRCULATOR AF30H**

MOTOR	BLADE	GUARD (2 REQ)
		
<p align="center"><b>3900-11014-000</b> AF30HA</p>	<p align="center"><b>1210-2026-000</b> AF30H AF30HA</p>	<p align="center"><b>372-079-Y</b> AF30H AF30HA</p>
SWITCH		CORD
		
<p align="center"><b>5216-2051-001</b> AF30H</p>	<p align="center"><b>1016-11054-001</b> AF30HA</p>	<p align="center"><b>1420-11004-000</b> AF30HA</p>

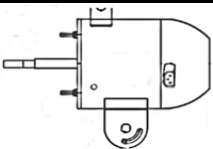
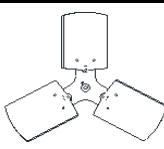
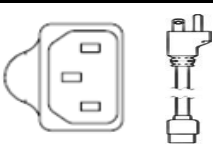
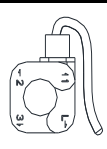

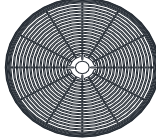
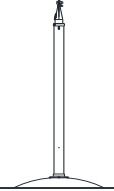

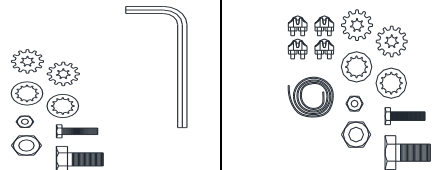

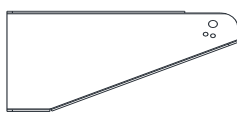
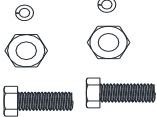
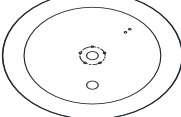
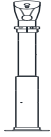
**PLUG CONFIGURATION ABOVE IS ONLY TYPE AVAILABLE, IF MOTORS USE DIFFERENT CONFIGURATION THE MOTOR MUST BE REPLACED AS WELL.**

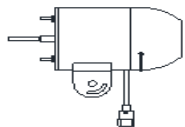
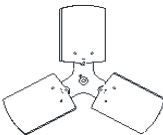
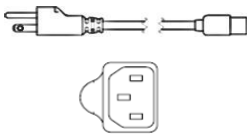
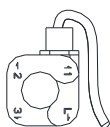

## HIGH PERFORMANCE AIR CIRCULATOR MACH 24 & 30

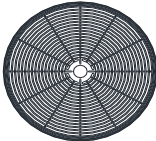
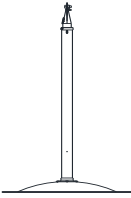
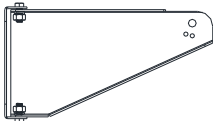
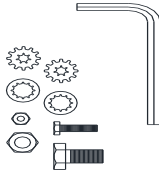
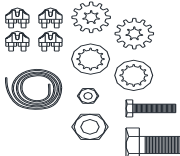

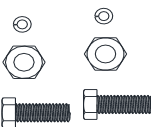
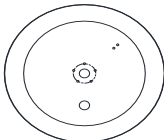







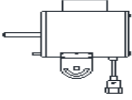
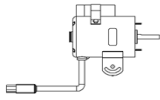
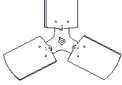

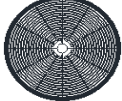

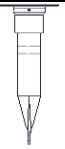
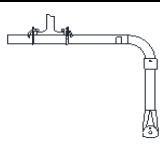

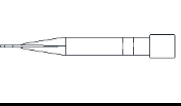

MOTOR	BLADE		CORD	SWITCH
				
<b>3900-11011-000</b> MACH24A MACH24P MACH24W MACH30A MACH30P MACH30W	<b>1210-2014-000</b> MACH24A MACH24P MACH24W	<b>1210-2026-000</b> MACH30A MACH30P MACH30W	<b>1420-11004-000</b> MACH24A MACH24P MACH24W MACH30A MACH30P MACH30W	<b>5216-2059-000</b> MACH24A MACH24P MACH24W MACH30A MACH30P MACH30W
<b>GUARD REAR</b>		<b>GUARD FRONT</b>		
				
<b>2504-2039-004</b> MACH24A MACH24P MACH24W	<b>2504-2037-004</b> MACH30A MACH30P MACH30W	<b>2504-2040-004</b> MACH24A MACH24P MACH24W	<b>2504-2038-004</b> MACH30A MACH30P MACH30W	
<b>MOUNTING KIT* (COMPLETE ASY)</b>		<b>ACCESSORY KIT</b>		
				
<b>2430PBA</b> MACH24P MACH30P	<b>2430WGA</b> MACH24W MACH30W	<b>002-057</b> MACH24P MACH30P	<b>3277</b> MACH24W MACH30W	
<b>WALL MT BASE</b>	<b>WALL MT ARM</b>	<b>WALL MT KIT</b>	<b>PEDESTAL BASE</b>	<b>COLUMN</b>
				
<b>045-131-B</b> MACH24W MACH30W	<b>1215-2233-000</b> MACH24W MACH30W	<b>991-473</b> MACH24W MACH30W	<b>1208-2013-001</b> MACH24P MACH30P	<b>1446-0003-002</b> MACH24P MACH30P
<b>PLUG CONFIGURATION ABOVE IS ONLY TYPE AVAILABLE, IF MOTORS USE DIFFERENT CONFIGURATION THE MOTOR MUST BE REPLACED AS WELL.</b>				

## INDUSTRIAL AIR CIRCULATOR 24ACH & 30ACH

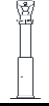







MOTOR	BLADE		CORD	SWITCH
				
<b>3900-11009-000</b> 24ACHA 24ACHP 24ACHW 30ACHA 30ACHP 30ACHW	<b>1210-2014-000</b> 24ACHA 24ACHP 24ACHW	<b>1210-2026-000</b> 30ACHA 30ACHP 30ACHW	<b>1420-11004-000</b> 24ACHA 24ACHP 24ACHW 30ACHA 30ACHP 30ACHW	<b>5216-2059-000</b> 24ACHA 24ACHP 24ACHW 30ACHA 30ACHP 30ACHW
GUARD REAR		GUARD FRONT		
				
<b>2504-2039-004</b> 24ACHA 24ACHP 24ACHW	<b>2504-2037-004</b> 30ACHA 30ACHP 30ACHW	<b>2504-2040-004</b> 24ACHA 24ACHP 24ACHW	<b>2504-2038-004</b> 30ACHA 30ACHP 30ACHW	
MOUNTING KIT* (COMPLETE ASY)		ACCESSORY KIT		
				
<b>2430PBA</b> 24ACHP 30ACHP	<b>2430WGA</b> 24ACHW 30ACHW	<b>002-057</b> 24ACHP 30ACHP	<b>3277</b> 24ACHW 30ACHW	
WALL MT BASE	WALL MT ARM	WALL MT KIT	PEDESTAL BASE	COLUMN
				
<b>045-131-B</b> 24ACHW 30ACHW	<b>1215-2233-000</b> 24ACHW 30ACHW	<b>991-473</b> 24ACHW 30ACHW	<b>1208-2013-001</b> 24ACHP 30ACHP	<b>1446-0003-002</b> 24ACHP 30ACHP
PLUG CONFIGURATION ABOVE IS ONLY TYPE AVAILABLE, IF MOTORS USE DIFFERENT CONFIGURATION THE MOTOR MUST BE REPLACED AS WELL.				

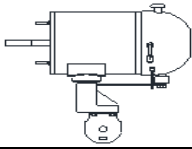
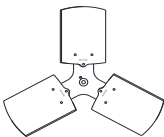
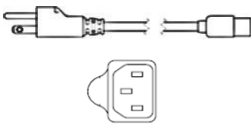
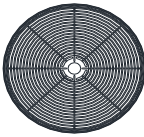
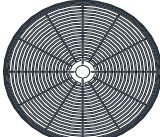
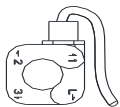
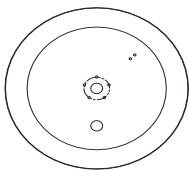

**EXTRA HEAVY DUTY AIR CIRCULATOR 24HDH 30HDH & 36HDH SERIES**

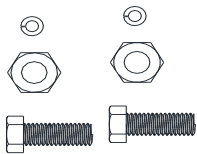
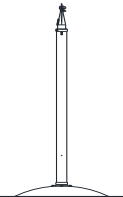
MOTOR		BLADE			
					
<b>3900-11013-000</b> 24HDHA 24HDHC 24HDHI 24HDHP 24HDHW 30HDHA 30HDHC 30HDHI 30HDHP 30HDHW	<b>3900-11030-000</b> 30HDHB 30HDHCB 30HDHIB 30HDHPB 30HDHWB 36HDHA 36HDHB	<b>1210-2035-000</b> 24HDHA 24HDHC 24HDHI 24HDHP 24HDHW  <b>1210-2026-001</b> 30HDHA 30HDHC 30HDHI 30HDHP 30HDHW	<b>1210-2037-000</b> 36HDHA 36HDHB  <b>LCCLIN3016BL</b> 30HDHB 30HDHCB 30HDHIB 30HDHPB 30HDHWB		
GUARD REAR		GUARD FRONT			
					
<b>2504-2039-004</b> 24HDHA 24HDHC 24HDHI 24HDHP 24HDHW	<b>2504-2037-004</b> 30HDHA 30HDHB 30HDHC 30HDHCB 30HDHI 30HDHP 30HDHIB	<b>2504-2040-004</b> 24HDHA 24HDHC 24HDHI 24HDHP 24HDHW	<b>2504-2038-004</b> 30HDHA 30HDHB 30HDHC 30HDHCB 30HDHI 30HDHP 30HDHIB	<b>PULL CHAIN SWITCH</b> 	
<b>2504-2048-004</b> 36HDHA 36HDHB	<b>2504-2049-004</b> 30HDHCB 30HDHIB 30HDHP 30HDHPB 30HDHW 30HDHWB	<b>2504-2049-004</b> 36HDHA 36HDHB	<b>2504-2038-004</b> 30HDHCB 30HDHIB 30HDHP 30HDHPB 30HDHW 30HDHWB	<b>5216-2059-000</b> ALL MODELS	
MOUNTING KIT* (COMPLETE ASY)				CORD	PARTS KIT
					<b>PICTURE NOT AVAILABLE</b>
<b>2430C</b> 24HDHC 30HDHC 30HDHCB	<b>2430I</b> 24HDHI 30HDHI 30HDHIB	<b>2430PBA</b> 24HDHP 30HDHP 30HDHPB	<b>2430WGA</b> 24HDHW 30HDHW 30HDHWB	<b>1420-11004-000</b> WITH 3900-11030-000 MOTORS ONLY	<b>1016-0068-000</b> ALL MODELS
I-BEAM CLAMPS	I-BEAM BENT	I-BEAM 13"	CEILING MOUNT	PEDESTAL BASE	COLUMN
					
<b>LPIBC</b> 24HDHI 30HDHI 30HDHIB	<b>LIB002</b> 24HDHI 30HDHI 30HDHIB	<b>LIB003</b> 24HDHC 24HDHI 30HDHC 30HDHCB 30HDHI 30HDHIB	<b>L2430CM</b> 24HDHC 30HDHC 30HDHCB	<b>1208-2013-001</b> 24HDHP 30HDHP 30HDHPB	<b>1446-0003-002</b> 24HDHP 30HDHP 30HDHPB
WALL MT BASE	WALL MT ARM	WALL MT KIT	PULLCHAIN STRING	ACCESSORY KIT	
					
<b>045-131-B</b> 24HDHW 30HDHW 30HDHWB	<b>1215-2233-000</b> 24HDHW 30HDHW 30HDHWB	<b>991-473</b> 24HDHW 30HDHW 30HDHWB	<b>3378</b> 24HDHC 24HDHI 24HDHW 30HDHC 30HDHCB 30HDHI 30HDHIB 30HDHW 30HDHWB	<b>3277</b> 24HDHC 24HDHI 24HDHW 30HDHC 30HDHCB 30HDHI 30HDHIB 30HDHW 30HDHWB	<b>002-057</b> 24HDHP 30HDHP 30HDHPB
<p><b>PLUG CONFIGURATION ABOVE IS ONLY TYPE AVAILABLE, IF MOTORS USE DIFFERENT CONFIGURATION THE MOTOR MUST BE REPLACED AS WELL.</b></p>					

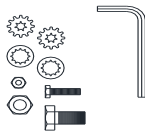
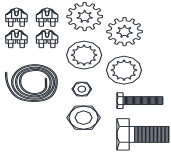
## INDUSTRIAL OSCILLATING AIR CIRCULATOR 24ACHO & 30ACHO

MOTOR	BLADE		CORD	HARDWARE KIT
				<b>PICTURE NOT AVAILABLE</b>
<b>3900-11010-000</b> 24ACHOA 24ACPOUA 24ACWOUA 30ACHOA 30ACPOUA 30ACWOUA	<b>1210-2014-000</b> 24ACHOA 24ACPOUA 24ACWOUA	<b>1210-2026-000</b> 30ACHOA 30ACPOUA 30ACWOUA	<b>1420-11004-000</b> 24ACHOA 24ACPOUA 24ACWOUA 30ACHOA 30ACPOUA 30ACWOUA	<b>4092</b> 24ACPOUA 24ACWOUA 30ACPOUA 30ACWOUA
<b>GUARD REAR</b>		<b>GUARD FRONT</b>		<b>SWITCH</b>
				
<b>2504-2039-004</b> 24ACHOA 24ACPOUA 24ACWOUA	<b>2504-2037-004</b> 30ACHOA 30ACPOUA 30ACWOUA	<b>2504-2040-004</b> 24ACHOA 24ACPOUA 24ACWOUA	<b>2504-2038-004</b> 30ACHOA 30ACPOUA 30ACWOUA	<b>5216-2059-000</b> 24ACHOA 24ACPOUA 24ACWOUA 30ACHOA 30ACPOUA 30ACWOUA
<b>PEDESTAL BASE</b>	<b>COLUMN</b>	<b>WALL MT BASE</b>	<b>WALL MT ARM</b>	<b>WALL MT KIT</b>
				
<b>1208-2013-001</b> 24ACPOUA 30ACPOUA	<b>1446-0003-002</b> 24ACPOUA 30ACPOUA	<b>045-131-B</b> 24ACWOUA 30ACWOUA	<b>1215-2233-000</b> 24ACWOUA 30ACWOUA	<b>991-473</b> 24ACWOUA 30ACWOUA
<b>MOUNTING BKT (COMPLETE)</b>		<b>ACCESSORY KIT</b>		
				
<b>2430PBA</b> 24ACPOUA 30ACPOUA	<b>2430WGA</b> 24ACWOUA 30ACWOUA	<b>002-057</b> 24ACPOUA 30ACPOUA	<b>3277</b> 24ACWOUA 30ACWOUA	
<b>PLUG CONFIGURATION ABOVE IS ONLY TYPE AVAILABLE, IF MOTORS USE DIFFERENT CONFIGURATION THE MOTOR MUST BE REPLACED AS WELL.</b>				



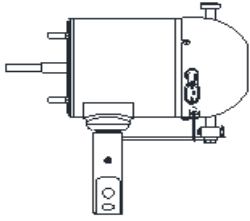
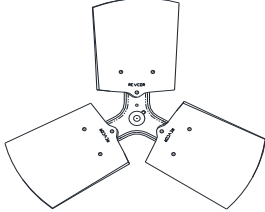
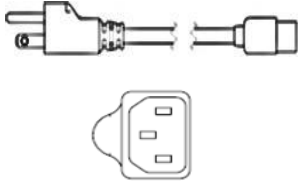
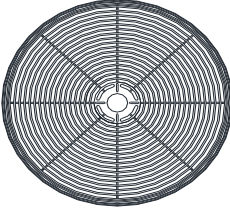
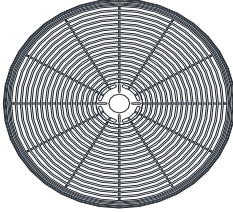
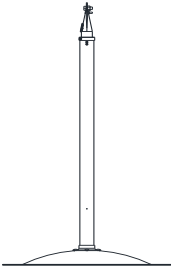
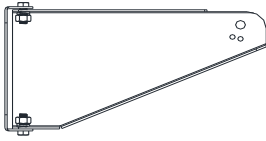

## LCHHD HEAVY DUTY OSSILLATING AIR CIRCULATOR

MOTOR	BLADE		CORD
			
<b>3900-11012-000</b> LCHHD240 LCHHD300	<b>1210-2014-000</b> LCHHD240	<b>1210-2026-000</b> LCHHD300	<b>1420-11004-000</b> LCHHD240 LCHHD300
GUARD REAR		GUARD FRONT	
			
<b>2504-2039-004</b> LCHHD240	<b>2504-2037-004</b> LCHHD300	<b>2504-2040-004</b> LCHHD240	<b>2504-2038-004</b> LCHHD300
MOUNTING KIT (COMPLETE)		PARTS KIT	
		PICTURE NOT AVAILABLE	
<b>2430PBA</b> LCHHD247 LCHHD307	<b>2430WGA</b> LCHHD247 LCHHD307	<b>3303-2015-000</b> LCHHD240 LCHHD300	
<b>PLUG CONFIGURATION ABOVE IS ONLY TYPE AVAILABLE, IF MOTORS USE DIFFERENT CONFIGURATION THE MOTOR MUST BE REPLACED AS WELL.</b>			



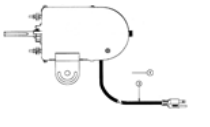
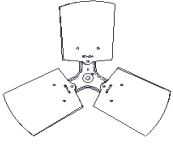
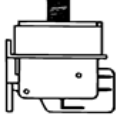

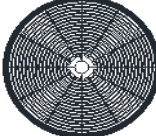

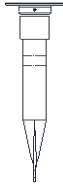
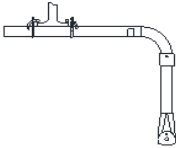
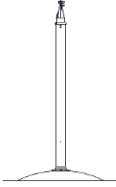

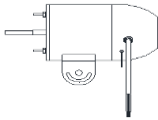
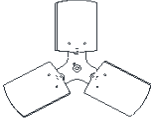

**LCHWD SPECIALTY WASH DOWN CIRCULATOR**

MOTOR	BLADE		SWITCH	SWITCH BULB
				
<b>3900-2063-000</b> LCHWD24 LCHWD24WB LCHWD30 LCHWD30WB LCHWD30CM LCHWD30LIB LCHWD30P	<b>LCCLIN2419BL</b> LCHWD24 LCHWD24WB	<b>LCCLIN30BL</b> LCHWD30 LCHWD30WB LCHWD30CM LCHWD30LIB LCHWD30P	<b>LP054</b> LCHWD24 LCHWD24WB LCHWD30 LCHWD30WB LCHWD30CM LCHWD30LIB LCHWD30P	<b>LP055</b> LCHWD24 LCHWD24WB LCHWD30 LCHWD30WB LCHWD30CM LCHWD30LIB LCHWD30P
<b>GUARD REAR</b>		<b>GUARD FRONT</b>		
				
<b>2504-2039-003</b> LCHWD24 LCHWD24WB	<b>2504-2037-003</b> LCHWD30 LCHWD30WB LCHWD30CM LCHWD30LIB LCHWD30P	<b>2504-2040-003</b> LCHWD24 LCHWD24WB	<b>2504-2038-003</b> LCHWD30 LCHWD30WB LCHWD30CM LCHWD30LIB LCHWD30P	
<b>MOUNTING KIT (COMPLETE)</b>				
				
<b>LWBWD</b> LCHWD24WB LCHWD30WB	<b>LCMWD</b> LCHWD30CM	<b>LIBWD</b> LCHWD30LIB	<b>LFPCBWD</b> LCHWD30P	

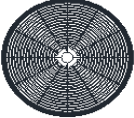
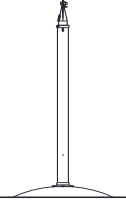

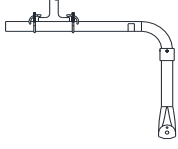



**LCHHD SPECIALTY 277V AIR CIRCULATOR**



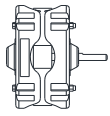
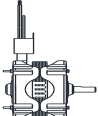
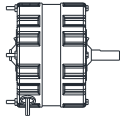
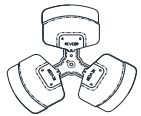
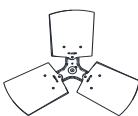
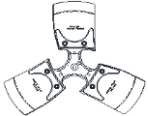
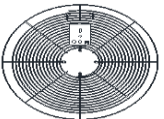

MOTOR		BLADE		CORD
				
3900-2078-000 LCHHD247 LCHHD307		1210-2014-000 LCHHD247		1210-2026-000 LCHHD307
1420-2013-500 LCHHD247 LCHHD307				
GUARD REAR		GUARD FRONT		
				
2504-2039-004 LCHHD247		2504-2037-004 LCHHD307		2504-2040-004 LCHHD247
2504-2038-004 LCHHD307				
MOUNTING KIT (COMPLETE)				
				
				
2430PBA LCHHD247 LCHHD307		2430C LCHHD247 LCHHD307		2430I LCHHD247 LCHHD307
2430WGA LCHHD247 LCHHD307				

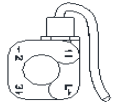



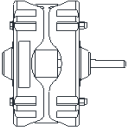
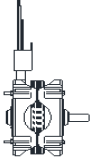
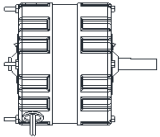
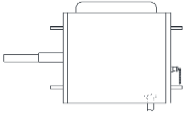
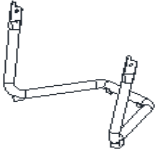
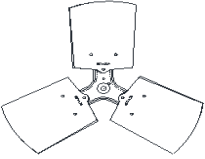
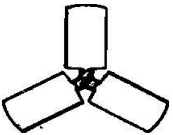

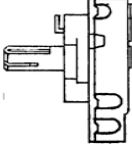
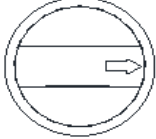
**B-SERIES UTILITY CIRCULATORS**

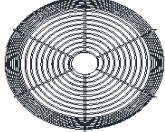
MOTOR			BLADE		
					
<b>517-116-BL</b> B12P B12PA <b>517-117-BL</b> B14 B14A	<b>517-084-BL</b> B18 B18A B20P B20PA	<b>517-103</b> B18TE B18TEA	<b>1210-2027-000</b> B12PA	<b>1210-2023-000</b> B14 B14A <b>1210-2013-000</b> B18 B18A B18TE B18TEA	<b>1210-2036-000</b> B20PA
GUARD REAR			GUARD FRONT		
					
<b>372-050-AG</b> B12P B12PA <b>372-074-AG</b> B14A	<b>372-054-AG</b> B18 B18A B18TE B18TEA	<b>372-056-AG</b> B20P B20PA	<b>372-065-AG</b> B12P B12PA <b>372-066-AG</b> B14 B14A	<b>372-067-AG</b> B18 B18A B18TE B18TEA <b>372-078-AG</b> B20P B20PA	
YOKE			CORD	SWITCH	
					
<b>3338</b> B12P B12PA <b>3339</b> B14 B14A	<b>1363</b> B18 B18A B18TE B18TEA	<b>4174</b> B20P B20PA	<b>118</b> ALL MODELS	<b>5216-2059-000</b> ALL MODELS	





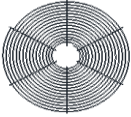
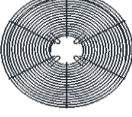

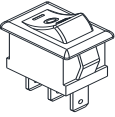
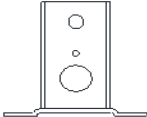



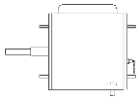

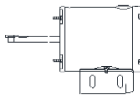
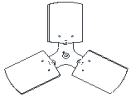
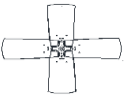





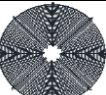

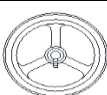
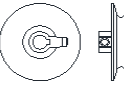
### I-SERIES INDUSTRIAL FLOOR CIRCULATOR

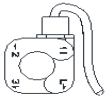
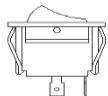
I-SERIES INDUSTRIAL FLOOR CIRCULATOR						
MOTOR				STAND		
			PICTURE NOT AVAILABLE			
517-116-BL I12	517-084-BL I18 I20 I20CA	517-103 I18TE	517-089 I24	1010MB I30	991-629-C I18 I18TE	
BLADE			CORD	SWITCH	KNOB	
	PICTURE NOT AVAILABLE					
1210-2013-000 I18 I18TE	991-284 I20 I20CA	1210-2026-000 I30	118 I12 I18 I18TE I20 I20CA	16000 I12 I18 I18TE I20 I20CA	441-229-B I12 I18 I18TE I20 I20CA I24	
GUARD REAR		GUARD FRONT				
						
372-054-AG I18 I18TE	372-065-AG I12	372-067-AG I18 I18TE	372-078-AG I20 I20CA			

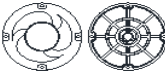



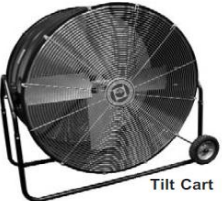



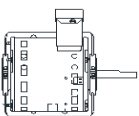
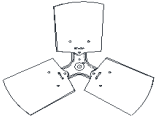
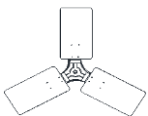
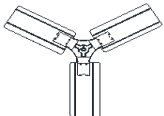
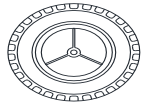
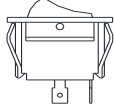

### NAVY FAN N12

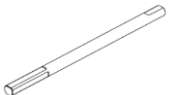
MOTOR	BLADE	GUARD FRT	GUARD BCK
			
3900-11027-000 N12A	1210-2027-001 N12 N12A	372-045-OP N12 N12A	372-046-OP N12 N12A
SWITCH	BASE ASY		
			
4425 N12 N12A	991-124-OP N12 N12A		

**MVB SERIES DRUM BLOWER**

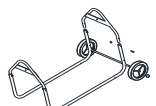

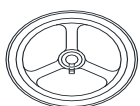
MVB SERIES DRUM BLOWER						
MOTOR			BLADE		CART ASY	SAFETY CABLE
						
<b>1010MB</b> MVB30DA MVB30DB MVB30DS <b>517-133</b> MVB30DC MVB36DA MVB36DB MVB36DC MVB36DS	<b>3900-2068-000</b> MVB36B MVB42B	<b>3900-11001-000</b> MVB42DB MVB42DS MVB48DB	<b>1210-2026-000</b> MVB30DA MVB30DB MVB30DC MVB30DS <b>1210-10558-000</b> MVB42DB MVB42DS <b>1210-10560-000</b> MVB48DB	<b>1210-2012-000</b> MVB36DA MVB36DB MVB36DC MVB36DS	<b>1016-10724-000</b> MVB30DC <b>1016-10724-001</b> MVB36DC	<b>9G053947</b> MVB30DS MVB36DS MVB42DS
WHEEL AXLE	WHEEL (2REQ)	HANDLE	GUARD (2REQ)		PULLEY FAN	
						
<b>1017-0003-000</b> MVB30DA MVB30DB MVB36B MVB36DA MVB36DB MVB42B MVB42DB MVB48DB <b>1017-0003-002</b> MVB30DC MVB36DC	<b>869-007</b> MVB30DA MVB30DB MVB30DC MVB36B MVB36DA MVB36DB MVB36DC MVB42B MVB42DB MVB48DB	<b>3232</b> MVB30DA MVB30DB MVB36B MVB36DA MVB36DB MVB42B MVB42DB MVB48DB	<b>3466-AG</b> MVB30DA MVB30DB MVB30DC MVB30DS <b>3293-AG</b> MVB42B MVB42DB MVB42DS <b>3294-AG</b> MVB48DB	<b>2794-AG</b> MVB36B MVB36DA MVB36DB MVB36DC MVB36DS	<b>1064</b> MVB36B <b>PULLEY MOTOR</b>   <b>2594</b> MVB36B <b>4507-2009-000</b> MVB42B	<b>612-015</b> MVB42B
PULL CHAIN SW.	PUSH SWITCH	ROTARY SWITCH	ROCKER SW.	BELT	SHAFT	BEARINGS (2REQ)
	PICTURE NOT AVAILABLE	PICTURE NOT AVAILABLE				
<b>5216-2059-000</b> MVB24D MVB30DA MVB30DB MVB30DC MVB30DS MVB36DA MVB36DB MVB36DC MVB36DS	<b>5216-2057-000</b> MVB24D	<b>5216-2058-000</b> MVB24D	<b>5216-2052-000</b> MVB36B MVB42B MVB42DB MVB42DS MVB48DB	2341 MVB36B 4160 MVB42B	682-269 MVB36B MVB42B	3764 MVB36B MVB42B
CORD						
<b>1420-2023-000</b> MVB42DB MVB42DS MVB48DB	  Standard  Tilt Cart 					

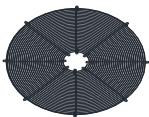
**IDF SERIES DRUM BLOWER**

IDF SERIES DRUM BLOWER				
MOTOR	BLADE			
				
<b>3900-11023-000</b> ALL MODELS	<b>1210-2020-001</b> IDF36B IDF36BC	<b>1210-2025-001</b> IDF42B IDF42BC	<b>1016-0044-001</b> IDF48B IDF48BC	
WHEEL (2REQ)	ROCKER SW.	BELT	PULLY MOTOR	
				
<b>869-007</b> ALL MODELS	<b>5216-2052-000</b> ALL MODELS	<b>9707-8055</b> ALL MODELS	<b>2594</b> ALL MODELS	
SHAFT	CORD	AXLE PILLOW BLK (2REQ)	CAPACITOR	
				
<b>8856-8014</b> ALL MODELS	<b>1420-2023-000</b> ALL MODELS	<b>1209-11001-000</b> ALL MODELS	<b>6100-8026</b> ALL MODELS	
CART ASY	WHEEL AXLE	PULLEY FAN	HANDLE	GUARD (2REQ)
				
<b>1016-10724-001</b> IDF36BC	<b>1017-0003-000</b> IDF36B	<b>612-015</b> ALL MODELS	<b>3232</b> IDF36B	<b>2794-AG</b> IDF36B
<b>1016-10724-002</b> IDF42BC	IDF42B IDF48B		IDF42B IDF48B	<b>3293-AG</b> IDF42B
<b>1016-10724-003</b> IDF48BC	<b>1017-0003-002</b> IDF36BC IDF42BC IDF48BC			<b>3294-AG</b> IDF48B IDF48BC

## INDUSTRIAL CEILING FANS



### BLADE (SET)

								
<b>9B3620-1</b> 36201	<b>9B4820-3</b> 48203	<b>9B5600-1</b> 56001	<b>9B6000-1</b> 60001	<b>9B5630-1R</b> 56301RDP				
<b>9B4820-1</b> 48201 48207	<b>9B5600-1LC</b> 56001LC 56101	56002 56003 56007	<b>9B6001-1</b> 60011					
<b>9B4820-1B</b> 48201B	56111	<b>9B5601-1</b> 56011	<b>9B6011-1</b> 60101 60111					
		<b>9B5600-1B</b> 56001B	<b>9B5620-1</b> 56201					

### DOWNROD 24"

### DOWNROD 8"

### MOTOR

		
---	---	---

<b>9D24BW</b> 36201 48201 56001LC 56001 56002 56003 56007 56301RDP 48203 48207 60001 56201	<b>9D24BLK</b> 48201B 56001B <b>9D24BB</b> 56011 60011 <b>9D12TW</b> 56101 56111 60101 60111	<b>9D08</b> 36201 48201 56001LC 56003 48203 <b>9D08BBLK</b> 48201B	<b>9M3620-1-A</b> 36201 <b>9M4820-1-A</b> 48201 <b>9M4820-1B-A</b> 48201B <b>9M4820-3-A</b> 48203 <b>9M5600-7-A</b> 48207 <b>6011-1U</b> 60111	<b>9M5600-1LC-A</b> 56001LC <b>9M5600-1-A</b> 56001 <b>9M5600-1B-A</b> 56001B <b>9M5600-4-A</b> 56002 <b>9M5600-3-A</b> 56003 <b>9M5600-7-A</b> 56007	<b>9M5601-1-A</b> 56011 <b>5611-1U</b> 56101 56111 <b>9M5630-1R-A</b> 56301RDP <b>9M6000-1-A</b> 60001 <b>9M6001-1-A</b> 60011 <b>9M5620-1-A</b> 56201
--	--	---	---	--	--

### RUBBER ROLLER

### J HOOK KIT

### BLADE SCREWS (6 REQ)

### BLADE PADS (3 REQ)

### REVERSIBLE TOGGLE

### REVERSING SW. PLATE



					
<b>9F2900-04A</b> ALL MODELS	<b>9F2900-01</b> ALL MODELS	<b>9F2900-20A</b> ALL MODELS	<b>9F2900-19A</b> ALL MODELS	<b>9F2GX54-73</b> 56301RDP	<b>9FP005</b> 56301RDP

### CANOPY UPPER

### CANOPY LOWER



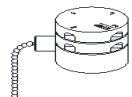



	
---	---

<b>9F2900-07A</b> 36201 48201 56001LC 56001 56002 56003 56007 56301RDP 48203 48207 60001 56201	<b>9F2900-07AB</b> 48201B 56001B <b>9FP029</b> 56011 60011 <b>3100039A</b> 56101 56111 60101 60111	<b>9F2900-08A</b> 36201 48201 56001LC 56001 56002 56003 56007	<b>9F2900-08B</b> 60001 60101 60111 56301RDP 48203 48207 56101 56111	<b>9F2900-08AB</b> 48201B 56001B <b>9FP030</b> 56011 60011
--	--	--	--	---

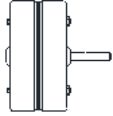
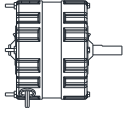
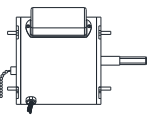
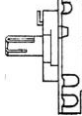
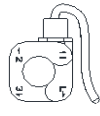
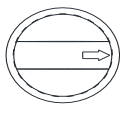
<b>3-SPEED PULL CHAIN SW.</b>	<b>PULL CHAIN STRING</b>	<b>OUTDOOR KIT</b>
		PICTURE NOT AVAILABLE
<b>9F2900-26</b> 48203 56003	<b>3378</b> 48203 56003	<b>99992</b> 56101 60101

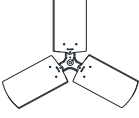
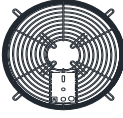
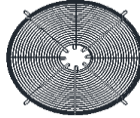
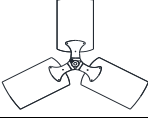

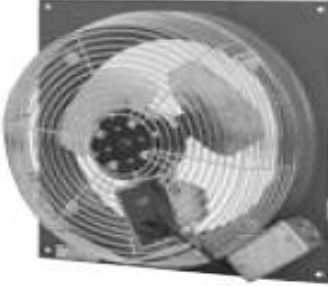

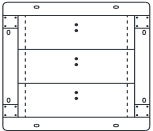
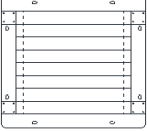



**LPE SERIES**

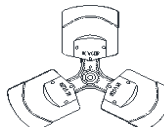
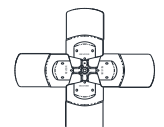
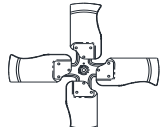
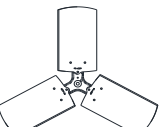
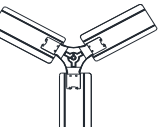



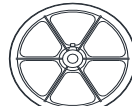

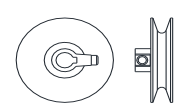
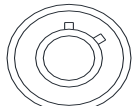
MOTOR			SWITCH		KNOB
					
<b>3808</b> LPE12 LPE12A LPE12S LPE12SA LPE12V LPE12VA	<b>517-103</b> LPE16 LPE16A LPE16S LPE16SA LPE16V LPE16VA	<b>3900-2040-000</b> LPE22V LPE22VA LPE24 LPE24A LPE24S LPE24SA LPE30 LPE30A LPE30S LPE30SA	<b>16000</b> LPE12 LPE12A LPE12S LPE12SA LPE12V LPE12VA LPE16 LPE16A LPE16S LPE16SA LPE16V LPE16VA	<b>5216-2059-000</b> LPE22V LPE22VA LPE24 LPE24A LPE24S LPE24SA LPE30 LPE30A LPE30S LPE30SA	<b>441-229-B</b> LPE12 LPE12A LPE12S LPE12SA LPE12V LPE12VA LPE16 LPE16A LPE16S LPE16SA LPE16V LPE16VA
BLADE ASY			GUARD		
					
<b>1210-2027-000</b> LPE12A LPE12SA LPE12VA	<b>490013001</b> LPE16A	<b>1210-2014-000</b> LPE24 LPE24A LPE24S LPE24SA	<b>372-082-AG</b> LPE12 LPE12A LPE12S LPE12SA	<b>372-086-AG</b> LPE16 LPE16A LPE16S LPE16SA	<b>372-087-AG</b> LPE24 LPE24A LPE24S LPE24SA
		<b>1210-2026-000</b> LPE30 LPE30A LPE30S LPE30SA	<b>372-085-AG</b> LPE12V LPE12VA	<b>372-084-AG</b> LPE16V LPE16VA	<b>372-088-AG</b> LPE30 LPE30A LPE30S LPE30SA
<b>1210-2029-000</b> LPE22V LPE22VA	<b>1210-2033-000</b> LPE16SA LPE16VA				<b>2504-2036-001</b> LPE22VA
SHUTTER		 <p align="center"><b>LPEV</b></p>  <p align="center"><b>LPES</b></p>			
					
<b>2644</b> LPE12S LPE12SA	<b>3538</b> LPE30S LPE30SA				
<b>2649</b> LPE16S LPE16SA					
<b>3534</b> LPE24S LPE24SA					

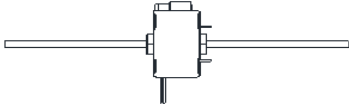
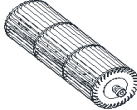
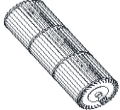

**BE SERIES COMMERCIAL BELT DRIVE EXHAUST FAN**

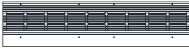
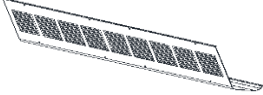
BLADE				
				
8528-8147 BE24	8528-8148 BE30	8528-8149 BE36	1210-2025-001 BE42	1016-0044-001 BE48
MOTOR		SHAFT-ARBOR	BELT	
				
3900-2068-000 BE24 BE30 BE36 BE42	517-083 BE48	5217-2006-000 BE24 BE30 BE36 BE42	9707-8053 BE24	9707-8055 BE30
			1230-0003-000 BE36	4280 BE42
PULLEY FAN	PULLEY MOTOR		BEARING (2 REQ)	
				
4436 BE24	612-019 BE24	4434 BE30	8526-8006 BE24 BE30 BE36 BE42	
1064 BE30 BE36	4507-2009-000 BE36	2594 BE42 BE48		
1804 BE42 BE48				

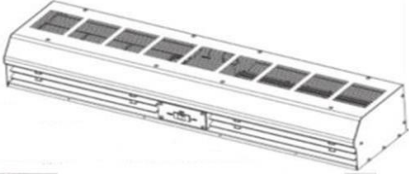

MLP LOW-PROFILE SERIES					
MOTOR		BLOWER WHEEL RIGHT		BLOWER WHEEL LEFT	
					
<b>3900-2090-000</b> MLP36001115GA MLP3600115GR MLP36001115GRSS MLP42001110GA MLP42001110GR MLP42001110GRSS MLP48001108GA MLP48001108GR MLP48001108GRSS MLP60001108GA MLP60001108GR MLP60001108GRSS	<b>3900-2093-001</b> MLP36001208GA MLP36001208GR MLP36001208GRSS MLP42001208GA MLP42001208GR MLP42001208GRSS MLP48001206GA MLP48001206GR MLP48001206GRSS MLP60001206GA MLP60001206GR MLP60001206GRSS	<b>1225-2024-000</b> MLP36001115GA MLP3600115GR MLP36001115GRSS MLP36001208GA MLP36001208GR MLP36001208GRSS  <b>1225-2024-001</b> MLP42001110GA MLP42001110GR MLP42001110GRSS MLP42001208GA MLP42001208GR MLP42001208GRSS	<b>1225-2024-002</b> MLP48001108GA MLP48001108GR MLP48001108GRSS MLP48001206GA MLP48001206GR MLP48001206GRSS  <b>1225-2024-003</b> MLP60001108GA MLP60001108GR MLP60001108GRSS MLP60001206GA MLP60001206GR MLP60001206GRSS	<b>1225-2025-000</b> MLP36001115GA MLP3600115GR MLP36001115GRSS MLP36001208GA MLP36001208GR MLP36001208GRSS  <b>1225-2025-001</b> MLP42001110GA MLP42001110GR MLP42001110GRSS MLP42001208GA MLP42001208GR MLP42001208GRSS	<b>1225-2025-002</b> MLP48001108GA MLP48001108GR MLP48001108GRSS MLP48001206GA MLP48001206GR MLP48001206GRSS  <b>1225-2025-003</b> MLP60001108GA MLP60001108GR MLP60001108GRSS MLP60001206GA MLP60001206GR MLP60001206GRSS
CORD		GRILLE			SWITCH
					
<b>1420-2038-004</b> MLP36001115GA MLP3600115GR MLP36001115GRSS MLP42001110GA MLP42001110GR MLP42001110GRSS MLP48001108GA MLP48001108GR MLP48001108GRSS MLP60001108GA MLP60001108GR MLP60001108GRSS	<b>1420-2044-001</b> MLP36001208GA MLP36001208GR MLP36001208GRSS MLP42001208GA MLP42001208GR MLP42001208GRSS MLP48001206GA MLP48001206GR MLP48001206GRSS MLP60001206GA MLP60001206GR MLP60001206GRSS	<b>1809-2033-800</b> MLP36001115GA MLP36001208GA  <b>1809-2033-801</b> MLP42001110GA MLP42001208GA  <b>1809-2033-802</b> MLP48001108GA MLP48001206GA  <b>1809-2033-803</b> MLP60001108GA MLP60001206GA	<b>2501-2090-900</b> MLP3600115GR MLP36001208GR  <b>2501-2090-901</b> MLP42001110GR MLP42001208GR  <b>2501-2090-902</b> MLP48001108GR MLP48001206GR  <b>2501-2090-903</b> MLP60001108GR MLP60001206GR	<b>2501-2090-200</b> MLP36001115GRSS MLP36001208GRSS  <b>2501-2090-201</b> MLP42001110GRSS MLP42001208GRSS  <b>2501-2090-202</b> MLP48001108GRSS MLP48001206GRSS  <b>2501-2090-203</b> MLP60001108GRSS MLP60001206GRSS	<b>790-188</b> ALL MODELS
					

**ENVIRONMENTAL SERIES AIR CURTAINS**

**MOTOR BLOWER ASY**

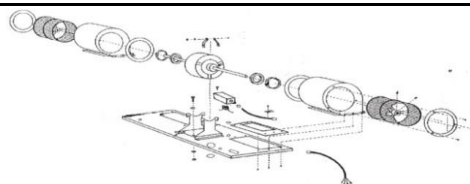

ACMB125	ACMB225	ACMB300		ACMB305	ACMB325	ACMB350	ACMB600	
E36001125	E36001225	E36001300	E84002300	E36001305	E36001325	E36001350	E36001675	
E38001125	E38001225	E36001375	E84002375	E36001405	E36001425	E36001450	E42001675	
E42001125	E42001225	E36001400	E84002400	E36001505	E36001525	E36001550	E60001675	
E48001125	E48001225	E36001475	E84002475	E38001305	E38001325	E38001350	E96002675	
E72002125	E60001225	E36001500	E84002500	E38001405	E38001425	E38001450	E10803675	
E76002125	E72002225	E36001575	E84002575	E38001505	E38001525	E38001550	<b>ACMB650</b>	
E84002125	E76002225	E38001300	E96002300	E42001305	E42001325	E42001350	E72002650	
E96002125	E84002225	E38001375	E96002375	E42001405	E42001425	E42001450	E10803650	
E10803125	E96002225	E38001400	E96002400	E42001505	E42001525	E42001550	<b>ACMB125D</b>	
E12003125	E10803225	E38001475	E96002475	E48001305	E48001325	E48001350	E60002125	
E13203125	E12003225	E38001500	E96002500	E48001405	E48001425	E48001450	<b>ACMB150D</b>	
E14403125	E13203225	E38001575	E96002575	E48001505	E48001525	E48001550	E60002150	
	E14403225	E42001300	E10803300	E60001305	E72002325	E72002350	<b>ACMB225D</b>	
<b>ACMB150</b>		E42001375	E10803375	E60001405	E72002425	E72002450	E60002225	
E36001150	<b>ACMB250</b>	E36001400	E10803400	E60001505	E72002525	E72002550	<b>ACMB250D</b>	
E38001150	E36001250	E42001400	E10803400	E72002305	E76002325	E76002350	E60002250	
E42001150	E38001250	E42001475	E10803475	E72002405	E76002425	E76002450	<b>ACMB325D</b>	
E48001150	E42001250	E42001475	E10803500	E72002405	E76002425	E76002450	E60002325	
E60001150	E48001250	E42001575	E10803575	E72002505	E76002525	E76002550	E60002425	
E72002150	E60001250	E48001300	E12003300	E76002305	E84002325	E84002350	E60002425	
E76002150	E72002250	E48001375	E12003375	E76002405	E84002425	E84002450	E60002525	
E84002150	E76002250	E48001400	E12003400	E76002505	E84002525	E84002550	<b>ACMB350D</b>	
E96002150	E84002250	E48001475	E12003475	E84002305	E84002325	E84002350	E96002350	
E10803150	E96002250	E48001500	E12003500	E84002405	E96002425	E96002450	E96002450	
E12002150	E10803250	E48001575	E12003575	E84002505	E96002525	E96002550	E60002350	
E12003150	E12003250	E60001300	E13203300	E96002305	E10803325	E10803350	E60002450	
E13203150	E13203250	E60001375	E13203375	E96002405	E10803425	E10803450	E60002550	
E14403150	E14403250	E60001400	E13203400	E96002505	E10803525	E10803550		
		E60001475	E13203475	E10803305	E12003325	E12003350		
<b>ACMB175</b>	<b>ACMB275</b>	E60001500	E13203500	E10803405	E12003425	E12003450		
E36001175	E36001275	E60001575	E13403575	E10803505	E12003525	E12003550		
E38001175	E38001275	E72002300	E14403300	E12003305	E13203325	E13203350		
E42001175	E42001275	E72002375	E14403375	E12003405	E13203425	E13203450		
E48001175	E48001275	E72002400	E14003400	E12003505	E13203525	E13403550		
E60001175	E60001275	E72002475	E14403475	E13203305	E14403325	E14403350		
E72002175	E72002275	E72002500	E14403500	E13203405	E14403425	E14403450		
E76002175	E76002275	E72002575	E14403575	E13203505	E14403525	E14403550		
E84002175	E84002275	E76002300		E14403305				
E96002175	E96002275	E76002375		E14403405				
E10803175	E10803275	E76002400		E14403505				
E12002175	E12003275	E76002475						
E12003175	E13203275	E76002500						
E13203175	E14403275	E76002575						
E14403175		E76002675						
		E76002750						
		E76002750						
<b>WIRE HARNESS</b>	<b>GRILLE KNURLED NUT</b>	<b>ROCKER SWITCH</b>						
	PICTURE NOT AVAILABLE							
<b>ACWS616</b>	<b>AP0002</b>	<b>C1220</b>						
ALL MODELS	ALL MODELS	E36001125	E60001175	E84002275	E13203250			
		E36001150	E60001225	E96002125	E13203275			
		E36001175	E60001250	E96002150	E14403125			
		E36001225	E60001275	E96002175	E14403150			
		E36001250	E60002125	E96002225	E14403175			
		E36001275	E60002150	E96002250	E14403225			
<b>CABINET ASY</b>		E38001125	E60002225	E96002275	E14403250			
1016-0096-000	36"	E38001150	E60002250	E10803125	E14403275			
1016-0096-001	38"	E38001175	E72002125	E10803150				
1016-0096-002	42"	E38001225	E72002150	E10803175				
1016-0096-003	48"	E38001250	E72002175	E10803225				
1016-0096-004	60"	E38001275	E72002225	E10803250				
1016-0096-005	60" DUALY	E42001125	E72002250	E10803275				
		E42001150	E72002275	E12002150				
		E42001175	E76002125	E12002175				
		E42001225	E76002150	E12003125				
		E42001250	E76002175	E12003150				
		E42001275	E76002225	E12003175				
<b>GRILLE ASY</b>		E48001125	E76002250	E12003225				
1016-0093-000	36"	E48001150	E76002275	E12003250				
1016-0093-001	38"	E48001175	E84002125	E12003275				
1016-0093-002	42"	E48001225	E84002150	E13203125				
1016-0093-003	48"	E48001250	E84002175	E13203150				
1016-0093-004	60"	E48001275	E84002225	E13203175				
		E60001150	E84002250	E13203225				

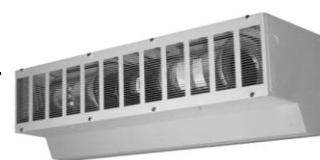

**NOTE**

5TH DIGIT IN MODEL NUMBER DETERMINS MOTOR AND WIRE HARNESS QTY.

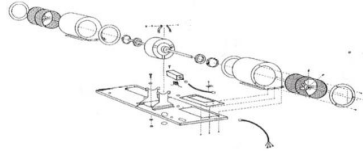

## HIGH VELOCITY SERIES AIR CURTAINS

### MOTOR BLOWER ASY





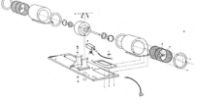

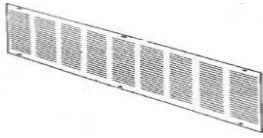
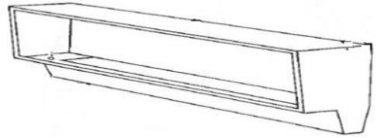
ACMB300		ACMB305		ACMB330											
EL36001300LI	EL76002500LI	EL36001305LI	EL76002505LI	EL36001330LI	EL76002530LI										
EL36001400LI	EL84002300LI	EL36001405LI	EL84002305LI	EL36001430LI	EL84002330LI										
EL36001500LI	EL84002400LI	EL36001505LI	EL84002405LI	EL36001530LI	EL84002430LI										
EL38001300LI	EL84002500LI	EL38001305LI	EL84002505LI	EL38001330LI	EL84002530LI										
EL38001400LI	EL96002300LI	EL38001405LI	EL96002305LI	EL38001430LI	EL96002330LI										
EL38001500LI	EL96002400LI	EL38001505LI	EL96002405LI	EL38001530LI	EL96002430LI										
EL42001300LI	EL96002500LI	EL42001305LI	EL96002505LI	EL42001330LI	EL96002530LI										
EL42001400LI	EL10803300LI	EL42001405LI	EL10803305LI	EL42001430LI	EL10803330LI										
EL42001500LI	EL10803400LI	EL42001505LI	EL10803405LI	EL42001530LI	EL10803430LI										
EL48001300LI	EL10803500LI	EL48001305LI	EL10803505LI	EL48001330LI	EL10803530LI										
EL48001400LI	EL12003300LI	EL48001405LI	EL12003305LI	EL48001430LI	EL12003330LI										
EL48001500LI	EL12003400LI	EL48001505LI	EL12003405LI	EL48001530LI	EL12003430LI										
EL60001300LI	EL12003500LI	EL60001305LI	EL12003505LI	EL60001330LI	EL12003530LI										
EL60001400LI	EL13203300LI	EL60001405LI	EL13203305LI	EL60001430LI	EL13203330LI										
EL60001500LI	EL13203400LI	EL60001505LI	EL13203405LI	EL60001530LI	EL13203430LI										
EL72002300LI	EL13203500LI	EL72002305LI	EL13203505LI	EL72002330LI	EL13203530LI										
EL72002400LI	EL14403300LI	EL72002405LI	EL14403305LI	EL72002430LI	EL14403330LI										
EL72002500LI	EL14403400LI	EL72002505LI	EL14403405LI	EL72002530LI	EL14403430LI										
EL76002300LI	EL14403500LI	EL76002305LI	EL14403505LI	EL76002330LI	EL14403530LI										
EL76002400LI		EL76002405LI		EL76002430LI											
<b>ACMB600</b> EL36001600LI EL60001600LI EL72002600LI EL96002600LI EL10803600LI		<b>ACMB605</b> EL96002605LI EL12003605LI		<b>ACMB630</b> EL96002630LI EL10803630LI EL12003630LI EL14403630LI											
<b>CABINET ASY</b>		<b>WIRE HARNESS</b>													
<table style="width: 100%; border-collapse: collapse;"> <tr> <td style="width: 80%;">1016-0096-000</td> <td style="width: 20%;">36"</td> </tr> <tr> <td>1016-0096-001</td> <td>38"</td> </tr> <tr> <td>1016-0096-002</td> <td>42"</td> </tr> <tr> <td>1016-0096-003</td> <td>48"</td> </tr> <tr> <td>1016-0096-004</td> <td>60"</td> </tr> </table>		1016-0096-000	36"			1016-0096-001	38"	1016-0096-002	42"	1016-0096-003	48"	1016-0096-004	60"	<b>ACW5616</b> ALL MODELS	
1016-0096-000	36"														
1016-0096-001	38"														
1016-0096-002	42"														
1016-0096-003	48"														
1016-0096-004	60"														
<b>GRILLE ASY</b>		<b>NOTE</b>		5TH DIGIT IN MODEL NUMBER DETERMINS MOTOR AND WIRE HARNESS QTY.											
<table style="width: 100%; border-collapse: collapse;"> <tr> <td style="width: 80%;">1016-0093-000</td> <td style="width: 20%;">36"</td> </tr> <tr> <td>1016-0093-001</td> <td>38"</td> </tr> <tr> <td>1016-0093-002</td> <td>42"</td> </tr> <tr> <td>1016-0093-003</td> <td>48"</td> </tr> <tr> <td>1016-0093-004</td> <td>60"</td> </tr> </table>		1016-0093-000	36"	1016-0093-001	38"	1016-0093-002	42"	1016-0093-003	48"	1016-0093-004	60"				
1016-0093-000	36"														
1016-0093-001	38"														
1016-0093-002	42"														
1016-0093-003	48"														
1016-0093-004	60"														

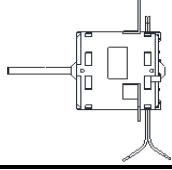
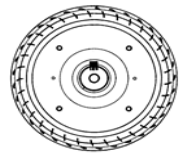

**SINGLE PHASE ENVIRONMENTAL SERIES ELECTRICALLY HEATED**

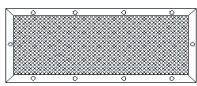





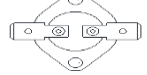
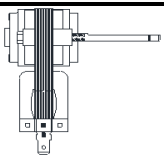



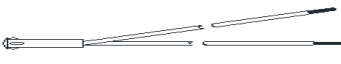
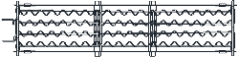

MOTOR BLOWER ASY	ELEMENT		THERMOSTAT	CABINET ASY	
	PICTURE NOT AVAILABLE				
ACMB125 ALL MODELS	APHE06240-1 E36061125H E42061125H E48061125H	APHE09240-1 E36091125H E42091125H E48091125H	T8775C1005 ALL MODELS		
GRILLE ASY			CABINET ASY		
					
1016-0093-000 E36061125H E36091125H	1016-0093-002 E42061125H E42091125H	1016-0093-003 E48061125H E48091125H	1016-0096-000 E36061125H E36091125H	1016-0096-002 E42061125H E42091125H	1016-0096-003 E48061125H E48091125H

**24" DRIVE-THRU WINDOW UNIT**

MOTOR (2 REQ)	IMPELLER (2 REQ)	CABINET	GRILLE	FILTER
				
3900-2069-000 E24001115F E24001115FG E24001115FHW E24001115G	8710-8022 E24001115F E24001115FG E24001115FHW E24001115G	1016-0109-000 E24001115F E24001115FG E24001115FHW E24001115G	2501-2066-000 E24001115F E24001115FG E24001115FHW E24001115G	2010-7009-028 E24001115F E24001115FHW 2010-7009-029 E24001115FG
				

**AFA SERIES (OBS)**

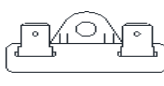



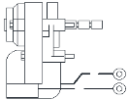
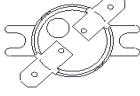

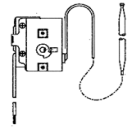
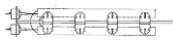
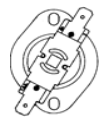
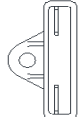
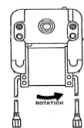
ELEMENTS					LIMIT			
								
<b>1802-2021-000</b>		<b>1802-2021-003</b>		<b>1802-2021-004</b>		<b>4520-2023-000</b>		
A1000IF	A1500IF	A1504IF	A1004IF	A2004T2B	A1000IF	A1500IFBNW	A2004IFB	
A1000IFA	A1500IFA	A1504IFA	A1004IFA	A2004T2BNW	A1000IFB	A1500T	A2004IFBNW	
A1000IFB	A1500IFB	A1504IFB	A1004IFB	A2404IF	A1000IFBNW	A1500T2B	A2004T	
A1000IFBNW	A1500IFBNW	A1504IFBNW	A1004IFBNW	A2404IFA	A1000T	A1500T2BNW	A2004T2B	
A1000T	A1500T	A1504T	A2004IF	A2404IFB	A1000T2B	A1504IF	A2004T2BNW	
A1000TA	A1500TA	A1504TA	A2004IFA	A2404IFBNW	A1000T2BNW	A1504IFB	A2404IF	
A1000T2	A1500T2	A1504T2	A2004IFB	A2404T	A1004IF	A1504IFBNW	A2404IFB	
A1000T2B	A1500T2B	A1504T2B	A2004IFBNW	A2404TA	A1004IFB	A1504T	A2404IFBNW	
A1000T2BNW	A1500T2BNW	A1504T2BNW	A2004T	A2404T2	A1004IFBNW	A1504T2B	A2404T	
			A2004TA	A2404T2B	A1500IF	A1504T2BNW	A2404T2B	
			A2004T2	A2404T2BNW	A1500IFB	A2004IF	A2404T2BNW	
<b>MOTOR</b>					<b>THERMOSTAT</b>			
								
<b>3900-2017-000</b>		<b>3900-2017-001</b>			<b>5813-2001-000</b>		<b>5813-2015-000</b>	
A0500IFA	A1000T2	A0504IFA	A1504IF	A2004TA	A0504TA	A0504T2	A1500T2BNW	
A0500IFB	A1000T2B	A0504IFB	A1504IFA	A2004T2	A1000T	A0504T2B	A1504T2B	
A0500IFBNW	A1000T2BNW	A0504IFBNW	A1504IFB	A2004T2B	A1000TA	A0504T2BNW	A1504T2BNW	
A0750IFA	A1500IF	A0504TA	A1504IFBNW	A2004T2BNW	A1500T	A1000T2	A2004T2	
A0750IFB	A1500IFA	A0504T2	A1504T	A2404IF	A1500TA	A1000T2B	A2004T2B	
A0750IFBNW	A1500IFB	A0504T2B	A1504TA	A2404IFA	A1504T	A1000T2BNW	A2004T2BNW	
A1000IF	A1500IFBNW	A0504T2BNW	A1504T2	A2404IFB	A1504TA	A1500T2	A2404T2B	
A1000IFA	A1500T	A0754IFA	A1504T2B	A2404IFBNW	A1504T2	A1500T2B	A2404T2BNW	
A1000IFB	A1500TA	A0754IFB	A1504T2BNW	A2404T	A2004T			
A1000IFBNW	A1500T2	A0754IFBNW	A2004IF	A2404TA	A2004TA			
A1000T	A1500T2B	A1004IF	A2004IFA	A2404T2	A2404T			
A1000TA	A1500T2BNW	A1004IFA	A2004IFB	A2404T2B	A2404TA			
		A1004IFB	A2004IFBNW	A2404T2BNW	A2404T2			
		A1004IFBNW	A2004T		A2404T2			

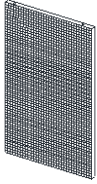
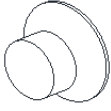

CRA SERIES									
KNOB		GRILLE	LIGHT				ELEMENT		
									
<b>3301-2039-002</b>		<b>2501-2065-000</b>	<b>3510-2017-000</b>	<b>3510-2017-001</b>	<b>3510-2017-002</b>	<b>3510-2017-003</b>	<b>1802-2124-005</b>	<b>1802-2124-000</b>	<b>1802-2124-003</b>
C1012T2	C1012T2AA	C1512IFB	C1012IF	C1024IF	C1512IFAB	C1024IFAB	C1024IF	C1512IF	C1012IFA
C1024T2	C1512T2AA	C1512T2B	C1012T2	C1024T2	C1512T2AB	C1024T2AB	C1024T2	C1512T2	C1012T2A
C1512T2	C1012T2AB	C2024IFB	C1512IF	C1524IF	C1512IFB	C1524IFAB	C2024IF	C1512IFA	<b>1802-2124-001</b>
C1524T2	C1024T2AB	C2024T2B	C1512T2	C1524T2	C1512T2B	C1524T2AB	C2024T2	C1512T2A	C2028IFA
C2024T2	C1512T2AB	C2028IFB	C1012IFA	C2024IF	C1512IFC	C2024IFAB	C1024IFA	<b>1802-2124-002</b>	C2028T2A
C2028T2	C1524T2AB	C2224IFB	C1012T2A	C2024T2	C1512T2C	C2024T2AB	C1024T2A	C2224IFA	<b>1802-2127-000</b>
C2224T2	C2024T2AB	C2224T2B	C1512IFA	C2028IF		C2028IFAB	C2024IFA	C2224T2A	C1512IFB
C1012T2A	C2224T2AB	C1512IFC	C1512T2A	C2028T2		C2224IFAB	C2024T2A	C2024T2A	C1512T2B
C1024T2A	C1512T2B	C1512T2C	C1012IFAA	C2224IF		C2224T2AB	<b>1802-2127-002</b>	C2024IFB	C1512IFC
C1512T2A	C2024T2B	C2024IFC	C1012T2AA	C2224T2		C2024IFB	C2224IFB	C2024T2B	C1512T2C
C1524T2A	C2224T2B	C2024T2C	C1512IFAA	C1024IFA		C2024T2B	C2224T2B	C2024IFC	<b>1802-2127-001</b>
C2024T2A	C1512T2C	C2028IFC	C1512T2AA	C1024T2A		C2028IFB	C2224IFC	C2024T2C	C2028IFB
C2028T2A	C2024T2C	C2224IFC	C1012IFAB	C1524IFA		C2224IFB	C2224T2C	C2028IFC	C2028IFC
C2224T2A	C2224T2C	C2224T2C	C1012T2AB	C1524T2A		C2224T2B	MODELS NOT LISTED ARE OBSOLETE		
				C2024IFA		C2024IFC			
				C2024T2A		C2024T2C			
				C2028IFA		C2028IFC			
				C2028T2A		C2224IFC			
				C2224IFA		C2224T2C			
				C2224T2A					
<b>FAN BLADE</b>	<b>MOTOR</b>			<b>HI LIMIT</b>				<b>CLIP N FIT BOARD</b>	
									
<b>1210-2008-000</b> ALL MODELS	<b>3900-2017-000</b>	<b>3900-2017-001</b>	<b>3900-2035-000</b>	<b>4520-11007-000</b>	<b>4520-11007-001</b>	<b>4520-2059-000</b>		<b>1249-2005-000</b>	
	C1012IF	C1024IF	C2028IF	C1512IFC	C2024IFC	C1012IF	C2024IF	C2224IFA	C1512IFB
	C1012T2	C1024T2	C2028T2	C1512T2C	C2024T2C	C1012T2	C2024T2	C2224T2A	C1512T2B
	C1512IF	C1524IF	C2224IF		C2028IFC	C1512IF	C1024IFA	C2028IFAB	C2024IFB
	C1512T2	C1524T2	C2224T2		C2224IFC	C1512T2	C1024T2A	C2224IFAB	C2024T2B
	C1012IFA	C2024IF	C2028IFA		C2224T2C	C1012IFA	C1524IFA	C2224T2AB	C2028IFB
	C1012T2A	C2024T2	C2028T2A			C1012T2A	C1524T2A	C2028IFB	C2224IFB
	C1512IFA	C1024IFA	C2224IFA			C1512IFA	C2024IFA	C2224IFB	C2224T2B
	C1512T2A	C1024T2A	C2224T2A			C1512T2A	C2024T2A	C2224T2B	C1512IFC
	C1012IFAA	C1524IFA	C2028IFAB			C1012IFAA	C1024IFAB		C1512T2C
	C1012T2AA	C1524T2A	C224IFAB			C1012T2AA	C1024T2AB		C2024IFC
	C1512IFAA	C2024IFA	C2224T2AB			C1512IFAA	C1524IFAB		C2024T2C
	C1512T2AA	C2024T2A	C2028IFB			C1512T2AA	C1524T2AB		C2028IFC
	C1012IFAB	C1024IFAB	C2224IFB			C1012IFAB	C2024IFAB		C2224IFC
	C1012T2AB	C1024T2AB	C2224T2B			C1012T2AB	C2024T2AB		C2224T2C
	C1512IFAB	C1524IFAB	C2028IFC			C1512IFAB	C2024IFB		
	C1512T2AB	C1524T2AB	C2224IFC			C1512T2AB	C2024T2B		
	C1512IFB	C2024IFAB	C2224T2C			C1512IFB	C2028IF		
	C1512T2B	C2024T2AB				C1512T2B	C2028T2		
	C1512IFC	C2024IFB				C1024IF	C2224IF		
	C1512T2C	C2024T2B				C1024T2	C2224T2		
		C2024IFC				C1524IF	C2028IFA		
		C2024T2C				C1524T2	C2028T2A		
<b>THERMOSTAT</b>		<b>THERMAL FUSE</b>							
									
<b>410130001</b>	<b>5813-2090-000</b>	<b>4520-2030-000</b>							
C1012T2	C1012T2AB	C1012IFAA	C1512IFB						
C1512T2	C1512T2AB	C1012T2AA	C1512T2B						
C1012T2A	C1512T2B	C1512IFAA	C2024IFB						
C1512T2A	C1512T2C	C1512T2AA	C2024T2B						
C1012T2AA	C1024T2AB	C1012IFAB	C2028IFB						
C1512T2AA	C1524T2AB	C1012T2AB	C2224IFB						
C1024T2	C2024T2AB	C1512IFAB	C2224T2B						
C1524T2	C2024T2B	C1512T2AB	C1512IFC						
C2024T2	C2024T2C	C1024IFAB	C1512T2C						
C1024T2A	C2224T2AB	C1024T2AB	C2024IFC						
C1524T2A	C2224T2B	C1524IFAB	C2024T2C						
C2024T2A	C2224T2C	C1524T2AB	C2028IFC						
C2028T2		C2024IFAB	C2224IFC						
C2224T2		C2024T2AB	C2224T2C						
C2028T2A		C2024IFB							
C2224T2A		C2024T2B							
		C2028IFAB							
		C2224IFAB							
		C2224T2AB							

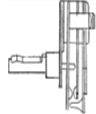
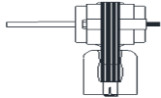





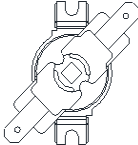
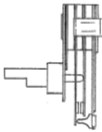
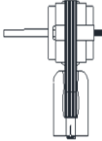

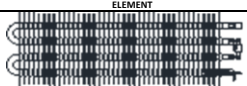

QVP					
MOTOR				LIMIT	
					
<b>42528-052-01</b>		<b>42528-052-02</b>		<b>4520-2025-000</b>	
VP1222	VP1222I	VP2022	VP2022I	VP1222C	VP2022IC
VP1222A	VP1222IB	VP2022A	VP2022IB	VP1222CNW	VP2022ICNW
VP1222AI	VP1222IBP	VP2022AI	VP2022IBP	VP1222IC	VP2422C
VP1222B	VP1222IC	VP2022B	VP2022IC	VP1222ICNW	VP2422CNW
VP1222C	VP1222ICNW	VP2022C	VP2022ICNW	VP2022C	VP2422IC
VP1222CNW		VP2022CNW		VP2022CNW	VP2422ICNW

A2500					
THERMOSTAT	ELEMENT	LIMIT	THERMAL FUSE	GRILLE	MOTOR
				PICTURE NOT AVAILABLE	
<b>1230-8232</b>	<b>6101-8752</b>	<b>8541-8056</b>	<b>8671-8037</b>	<b>8683-8272</b>	<b>8767-8036</b>
A2515T	A2530T	A2515T	A2515T	A2515T	A2515T
A2520T		A2520T	A2520T	A2520T	A2520T
A2530T		A2530T	A2530T	A2530T	A2530T
A2540T		A2540T	A2540T	A2540T	A2540T
A2548T		A2548T	A2548T	A2548T	A2548T



<b>1235 &amp; 2435 SERIES (OBS)</b>					
<b>SCREEN</b>		<b>KNOB</b>	<b>FACE PLATE</b>	<b>LIMIT</b>	
					
<b>1235-0037</b> 1235 2435	<b>8850-8046</b> 1235P 2435P	<b>3301-2047-000</b> ALL MODELS	<b>4503-2094-000</b> ALL MODELS	<b>8541-8054</b> ALL MODELS	
<b>THERMOSTAT</b>	<b>MOTOR</b>	<b>FAN BLADE</b>	<b>ELEMENT</b>	<b>THERMAL FUSE</b>	
					
<b>1230-8194</b> ALL MODELS	<b>1235-0007</b> ALL MODELS	<b>1235-0008</b> ALL MODELS	<b>6101-8741</b> ALL MODELS	<b>8671-8036</b> 2435 2435P	

<b>B2400 SERIES (OBS)</b>			
<b>ELEMENT</b>		<b>LIMIT</b>	<b>THERMOSTAT</b>
			
<b>6101-8741</b> B2451	<b>6101-8742</b> B2452	<b>8541-8055</b> ALL MODELS	<b>1230-8206</b> ALL MODELS
<b>MOTOR</b>		<b>FAN BLADE</b>	<b>THERMAL FUSE</b>
			
<b>8767-8035</b> B2451	<b>8767-8036</b> B2452	<b>991-313</b> ALL MODELS	<b>8671-8037</b> B2452

CWH2000										
ELEMENT							BLADE			
										
<b>302023801</b> CWH2101 CWH2101A CWH2101B CWH2101BWW CWH2101DS CWH2101DSB CWH2101DSBWW CWH2101DSBWW CWH2101F	<b>302023802</b> CWH2151 CWH2151A CWH2151B CWH2151BWW CWH2151DS CWH2151DSB CWH2151DSBWW CWH2151F	<b>302023803</b> CWH2157 CWH2157A CWH2157B CWH2157BWW CWH2157DSBWW CWH2157F	<b>302023804</b> CWH2208 CWH2208A CWH2208B CWH2208BWW CWH2208SBNW CWH2208F	<b>302023805</b> CWH2202 CWH2202A CWH2202B CWH2202BWW CWH2202DS CWH2202DSB CWH2202DSBWW CWH2202F	<b>302023806</b> CWH2207 CWH2207A CWH2207B CWH2207BWW CWH2207DS CWH2207DSB CWH2207DSBWW CWH2207F	<b>302023808</b> CWH2201 CWH2201A CWH2201B CWH2201BLT CWH2201BWW CWH2201DS CWH2201DSB CWH2201DSBWW CWH2201F	<b>490061001</b> ALL MODELS			
MOTOR				THERMOSTAT				KNOB		
										
<b>490062001</b> CWH2101 CWH2101A CWH2101B CWH2101BWW CWH2101DS CWH2101DSB CWH2101DSBWW CWH2101F CWH2151 CWH2151A CWH2151B CWH2151BWW CWH2151DS		<b>490062002</b> CWH2208 CWH2208A CWH2208B CWH2208BWW CWH2208SBNW CWH2208F	<b>490062003</b> CWH2202 CWH2202A CWH2202B CWH2202BWW CWH2202DS CWH2202DSB CWH2202DSBWW CWH2202F	<b>490062004</b> CWH2257 CWH2257A CWH2257B CWH2257BWW CWH2257F CWH2207 CWH2207A CWH2207B CWH2207BWW CWH2207DS CWH2207DSB CWH2207DSBWW CWH2207F	<b>5813-2001-000</b> CWH2101 CWH2101A CWH2101B CWH2101BWW CWH2101DS CWH2101DSB CWH2101DSBWW CWH2101F CWH2151 CWH2151A CWH2151B CWH2151BWW CWH2151DS CWH2151DSB CWH2151DSBWW CWH2151F CWH2157 CWH2157A CWH2157B CWH2157BWW CWH2157DSBWW CWH2157F		<b>5813-2022-000</b> CWH2201 CWH2201A CWH2201B CWH2201BWW CWH2201DS CWH2201DSB CWH2201DSBWW CWH2201F	<b>3301-2001-000</b> MODELS W/THERMOSTAT		
FAN DELAY		LIMIT		MANUAL RESET	LIGHT		DISCONNECT SW			
										
<b>410074000</b> CWH2101 CWH2101B CWH2101BWW CWH2101DS CWH2101DSB CWH2101DSBWW CWH2101F CWH2151 CWH2151B CWH2151BWW CWH2151DS CWH2151DSB CWH2151DSBWW CWH2157 CWH2157B CWH2157BWW CWH2157DSBWW CWH2157F CWH2201 CWH2201B CWH2201BLT CWH2201BWW		<b>1414-2009-000</b> CWH2101A CWH2101DS CWH2151A CWH2151DS CWH2157A CWH2201A CWH2201DS CWH2202A CWH2202DS CWH2207A CWH2207DS CWH2208A		<b>410143000</b> CWH2101 CWH2101B CWH2101BWW CWH2101DS CWH2101F CWH2151 CWH2151B CWH2151BWW CWH2151DS CWH2151F CWH2157 CWH2157B CWH2157BWW CWH2201F CWH2208 CWH2208B CWH2208BWW CWH2208F CWH2201 CWH2201B CWH2201BLT CWH2201BWW		<b>4520-11016-000</b> CWH2101A CWH2101DS CWH2151A CWH2157A CWH2201A CWH2201DS CWH2202A CWH2202DS CWH2207A CWH2207DS CWH2208A	<b>3510-2008-002</b> CWH2157B CWH22157BWW CWH2202B CWH2202BWW CWH2202DS CWH2202DSB CWH2207B CWH2207BWW CWH2208B CWH2208BWW CWH2208DSBWW		<b>3510-2008-003</b> CWH2101B CWH22101BWW CWH22101DS CWH22101DSB CWH22151B CWH22151BWW CWH22151DS CWH22151DSB CWH2201B CWH2201BWW CWH2201DS CWH2201DSB	<b>410170001</b> CWH2101DS CWH2101DSB CWH2101DSBWW CWH2151DS CWH2151DSB CWH2151DSBWW CWH2201DS CWH2201DSB CWH2201DSBWW CWH2202DS CWH2202DSB CWH2202DSBWW CWH2207DS CWH2207DSB CWH2207DSBWW CWH2208DSBWW

CU-A & CU-B OBSOLETE							
MODEL CU-B							
CABINET SERIES	PART NUMBER						
	FINTUBE HEATING ELEMENT (RETANGULAR ALUMINUM FIN)					FILTERS A & B MODELS	
	QTY.	208V	240V	277V & 480V 4-WIRE	480V 3-WIRE	THROWAWAY	REUSABLE
1200	2						
1300	3						
1400	4	1802-0103-001	1802-0103-002	1802-0103-003	1802-0103-004	2010-7008-001	2010-7009-001
1500	5						
1600	6						
2200	2						
2300	3						
2400	4	1802-0103-005	1802-0103-006	1802-0103-007	1802-0103-008	2010-7008-002	2010-7009-002
2500	5						
2600	6						
3200	2						
3300	3						
3400	4	1802-0103-009	-	1802-0103-011	1802-0103-012	2010-7008-003	2010-7009-003
3500	5						
3600	6						
4200	2						
4300	3						
4400	4	-	1802-0103-014	-	1802-0103-016	2010-7008-004	2010-7009-004
4500	5						
4600	6						
5200	2						
5300	3						
5400	4	-	-	-	-	2010-7008-005	2010-7009-005
5500	5						
5600	6						

MODELS CU-A & CU-B							
CABINET SERIES	PART NUMBER						
	BLOWER WHEEL	SHAFT	BEARINGS (2 EA)	COUPLING	FAN MOTOR	HIGH LIMIT	
						ALL EXCEPT CUI	CUI MODELS ONLY
1200-1600	6406-7001-001	-	-	-	3900-0558-000	4520-0011-007	-
2200-2600	6406-7001-001	-	-	-	3900-0559-000	4520-0011-007	-
3200-3600	6406-7001-002	5217-7007-001	2011-7017-000	1410-7003-001	3900-0563-000	-	4520-0011-009
4200-4600	6406-7001-002	5217-7007-002	2011-7017-000	1410-7003-001	3900-0563-000	-	4520-0011-009
5200-5600	6406-7001-002	5217-7007-003	2011-7017-000	1410-7003-001	3900-0563-000	-	4520-0011-009

PARTS COMMON TO ALL MODELS				CIRCUIT BREAKERS			
DESCRIPTION	PART NUMBER	VOLTAGE RATING	NUMBER OF POLES	AMPS	PART NUMBERS		
FAN RELAY:				15	4520-7009-014		
24V	CUBFDRK24			20	4520-7009-015		
120V	CUBFDRK120			25	4520-7009-016		
240V	CUBFDRK240			30	4520-7009-017		
SELECTOR SWITCH	5216-0302-000		2	35	4520-7009-018		
THERMOSTAT	-			40	4520-7009-019		
STEP-DOWN TRANSFORMER	5814-7013-003			45	4520-7009-020		
BUCK-BOOST TRANSFORMER	490015007			50	4520-7009-021		
SUMMER FAN SWITCH	5216-0302-000			60	4520-7009-022		
*CONTACTORS, CU-B				15	4520-7009-008		
2 POLE/30 AMP, 24V HOLDING COIL	5018-0003-000			20	4520-7009-004		
2 POLE/30 AMP, 120V HOLDING COIL	5018-0003-001			25	4520-7009-010		
2 POLE/30 AMP, 208V/240V HOLDING COIL	5018-0003-002			30	4520-7009-005		
3 POLE/ 35 AMP, 24V HOLDING COIL	5018-0005-004		3	35	4520-7009-011		
3 POLE/ 35 AMP, 120V HOLDING COIL	5018-0005-005			40	4520-7009-006		
3 POLE/ 35 AMP, 208V/240V HOLDING COIL	5018-0005-006			45	4520-7009-012		
*CONTACTORS, CU-A				50	4520-7009-001		
2 POLE/30 AMP, 24V HOLDING COIL	5018-0004-100			60	4520-7009-007		
2 POLE/30 AMP, 120V HOLDING COIL	5018-0004-101			15	4520-7008-013		
2 POLE/30 AMP, 208V/240V HOLDING COIL	5018-0004-102			20	4520-7008-014		
3 POLE/ 50 AMP, 24V HOLDING COIL	5018-0006-000			25	4520-7008-015		
3 POLE/ 50 AMP, 120V HOLDING COIL	5018-0006-001		2	30	4520-7008-016		
3 POLE/ 50 AMP, 208V/240V HOLDING COIL	5018-0006-002			35	4520-7008-017		
* SEE INSTALLATION INSTRUCTIONS FOR SELECTION CHART OR CONSULT FACTORY				40	4520-7008-018		
				50	4520-7008-020		
				60	4520-7008-021		
				15	4520-7008-005		
				20	4520-7008-006		
				25	4520-7008-008		
			3	30	4520-7008-001		
				35	4520-7008-009		
				40	4520-7008-007		

## Reference Data

### HOW TO ORDER

#### RATING SERIES PRODUCT NUMBERS

The last group of four numbers describe the Unit Size, Heating Capacity Voltage Rating and Type of Control:

Number of Fans and Cabinet Series are indicated by the first number.

1 - One Fan	Series 1000 Cabinet
2 - Two Fans	Series 2000 Cabinet
3 - Three Fans	Series 3000 Cabinet
4 - Four Fans	Series 4000 Cabinet
5 - Five Fans	Series 5000 Cabinet

Number of Fintube Heating Elements and the corresponding Unit Heating Capacity are indicated by the second number.

	Cabinet Series				
	1000	2000	3000	4000	5000
2 Element	2.0kW	4.0kW	5.3kW	6.7kW	8.0kW
3 Element	3.0kW	6.0kW	8.0kW	10.0kW	12.0kW
4 Element	4.0kW	8.0kW	10.7kW	13.3kW	16.0kW
5 Element	5.0kW	10.0kW	13.3kW	16.7kW	20.0kW*
6 Element	6.0kW	12.0kW	16.0kW	20.0kW	24.0kW*

Not available in all voltages. See table on page 2.

Electric Power Supply for the heating Circuit is indicated by the third number as follows:

1 - 208V Single Phase	4 - 240V Three Phase	7 - 480V Three Phase 3 Wire
2 - 208V Three Phase	5 - 277V Single Phase	8 - 347V Single Phase
3 - 240V Single Phase	6 - 480V Three Phase 4 Wire	9 - 600V Three Phase

Control Supply and Circuit are defined by the fourth number.

NOTE: A thermostat either integral or remote, must be used for proper operation of heater.

Thermostat	Voltage	Supply	For Use Only With Models	
0-	Integral	120	External	CUC, CUF, CUW
1-	Integral	24	External	CUC, CUF, CUW
2-	Integral	208/240*	Internal	CUC, CUF, CUW
3-	Remote	120	External	All Models
4-	Remote	24	External	All Models
5-	Remote	208/240*	Internal	All Models
6-	Remote	24	Internal	All Models
7-	Remote	120	Internal	All Models
8-	Integral	24	Internal	CUC, CUF, CUW
9-	Integral	120	Internal	CUC, CUF, CUW

\*Control Voltage is 208 VAC on units with 208 VAC Heating Circuit.



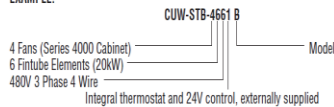

### MODEL LETTER

The letter "B" at the end of the catalog number designates the unit as a "B" model.

### EXAMPLE:

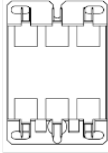
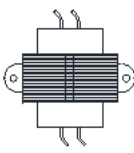

**VUH & VUH-A**

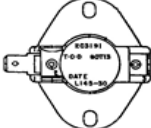
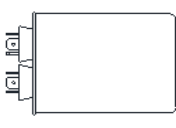
BLADE		RELAY		TRANSFORMER	
					
<b>490020000</b> H2520 H2524 H2548 H2555 H2560 H3020 H3024 H3048 H3055 H3060 H4020 H4024 H4048 H4055 H4060	<b>5018-0005-006</b> H1020A H1024A H1027A H1034A H1048A H1055A H1060A H1520A H1524A H1527A H1534A H1048A H1555A H1560A H2020 H2024 H2027 H2034 H2048 H2055 H2060	<b>5018-0006-002</b> H2520 H2524 H2548 H2555 H3020 H3024 H3048 H3055 H4020 H4024 H4048 H4055 H5020 H5024 H5060	<b>490015018</b> H1034A H1534A <b>490015019</b> H2034 <b>490015021</b> H1060A H1560A <b>490015005</b> H2027	<b>490015008</b> H5048 H5055 <b>490015012</b> H2060 H2560 H3060 H4060 <b>490015015</b> H5060	
LIMIT	FAN DELAY	CAPACITOR			
					
<b>410029000</b> ALL MODELS	<b>410126000</b> ALL MODELS	<b>1432-0002-003</b> ALL MODELS			

KD/KS			
UNIT SIZE	PART NUMBER		
	208V	240V	277V
ELEMENTS (AFTER 1993) (250 WATTS/FT. - SEE NOTE 1)			
24" CABINET	1802-2016-001	1802-2016-003	1802-2016-003
36" CABINET	1802-2016-009	1802-2016-010	1802-2016-011
48" CABINET	-	1802-2016-024	1802-2016-024
REPAIR PARTS (AFTER 1993)			
DISCRIPTION		PART NUMBER	
SPOT HIGH LIMIT		410027000	
OPT. THERMOSTAT, 1-POLE		410112000	
OPT. THERMOSTAT, 2-POLE		410113000	
OPTIONAL RELAY ( PRIOR TO 1993) (SEE NOTE 2)			
IDENTIFICATION NUMBER ON RELAY		PART NUMBER	
134-60103-301 (24V)		5018-2006-000	
134-60203-301 (120V)		5018-2021-001	
134-60303-301 (208V/240V)		5018-2006-002	
134-62303-301 (277V)		5018-2006-003	
NOTE 1: 500W/FT. UNITS REQUIRE 2 ELEMENTS. 750W/FT. UNITS REQUIRE 3 ELEMENTS. 1000W/FT. UNITS REQUIRE 4 ELEMENTS.			
NOTE 2: WITH SUFFIX "R" ADDED TO CATALOG NUMBER.			

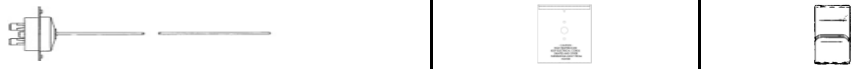
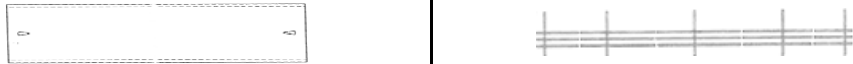
QDB SERIES				
				
DISCRIPTION	PART NUMBERS			
	120V	208V	240V	277V
*ELEMENT (100 WATTS/FT)				
38"	1802-2016-014	1802-2016-006	1802-2016-007	1802-2016-015
50"	1802-2016-016	1802-2016-017	1802-2016-018	1802-2016-019
62"	1802-2016-026	1802-2016-027	1802-2016-028	1802-2016-029
*ELEMENT (188 WATTS/FT)				
38"	1802-2016-012	1802-2016-010	1802-2016-011	1802-2016-013
50"	1802-2016-020	1802-2016-024	1802-2016-025	1802-2016-021
62"	1802-2016-030	1802-2016-034	1802-2016-035	1802-2016-031
				
LINEAR LIMIT		TERMINAL BOX COVER	ELEMENT HANGER CLIP	
38"	410122003	310527001	402020000	
50"	410122004			
62"	410122005			
				
FRONT COVER		TOP GRILLE ASSEMBLY		
38"	310124008	38"	310817903	
50"	310124009	50"	310817904	
62"	310124010	62"	31087905	

RDO SERIES				
KEY NUMBER	DESCRIPTION	PART NUMBER		
		RDO26	RDO35	RDO48
1	REFLECTOR: 60/90 SYM	-	-	-
	30 DEGREES SYM	-	-	-
	60/90 ASYM	-	-	-
	30 DEGREES ASYM	-	-	-
2	INSULATOR	-	-	-
3	TERMINAL BLOCK (4 REQ)	1224-0049-000	1224-0049-000	1224-0049-000
4	ELEMENT TERM. BUSH. (4 REQ)	1213-0070-000	1213-0070-000	1213-0070-000
SOME ELEMENTS AVAILABLE-SEE FACTORY				
QRH SERIES				
ELEMENTS	RH16-91S-208	2QL16208		
	RH16-91S-240	2QL16240		
	RH16-91S-277	2QL16277		

OBsolete INDUSTRIAL AIR CIRCULATORS			
BLADE			SWITCH
LCCLIN2419BL LCHHD24	1210-2035-000 LCHXN24	1210-2014-000 LCHIN24	5216-2059-000 LCHHD24
LCCLIN30BL LCHHD30	LCCLIN3016BL LCHXN30	1210-2026-000 LCHIN30	LCHHD30 LCHIN24 LCHIN30