



Better solutions through innovation

Service Manual

Model Number

EF2870L

EF2570G

UL Part Number

6909460159

6909450159

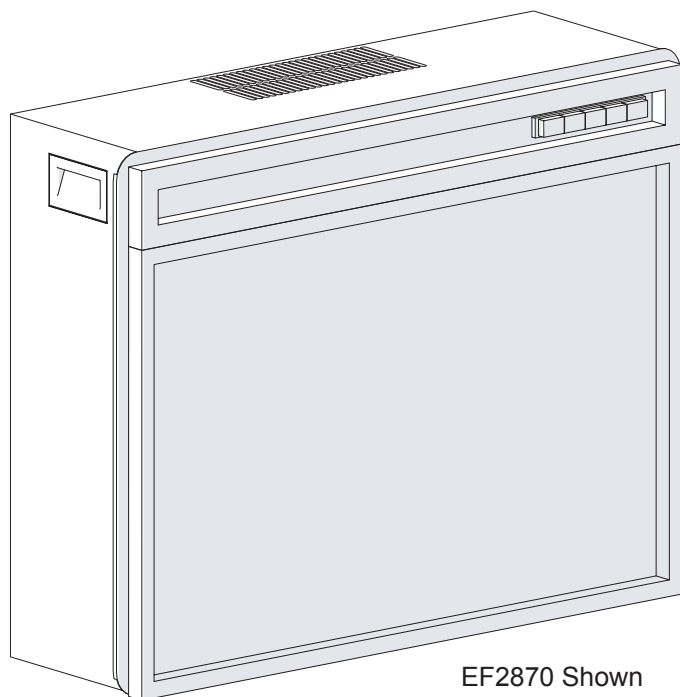

EF2870 Shown

IMPORTANT SAFETY INFORMATION: Always read this manual first before attempting to service this fireplace. For your safety, always comply with all warnings and safety instructions contained in this manual to prevent personal injury or property damage.

Dimplex North America Limited

1367 Industrial Road • Cambridge ON Canada N1R 7G8

1-888-346-7539 • www.dimplex.com

In keeping with our policy of continuous product development, we reserve the right to make changes without notice.

© 2015 Dimplex North America Limited

REV PCN DATE

00 - 16-APR-15

7400860000R00

TABLE OF CONTENTS

Operation	3
Exploded Parts Diagram - EF2870	5
Replacement Parts - EF2870	5
Exploded Parts Diagram - EF2570	6
Replacement Parts - EF2570	6
Wiring Diagram - EF2870	7
Wiring Diagram - EF2570	7
Flicker Motor Replacement	8
Flame LED Replacement	8
Cord Set Replacement	8
Display Board Replacement	8
IR Sensor Replacement	8
Thermistor Replacement	9
Heater Assembly Replacement	9
Switchboard Replacement	9
Control Board Replacement	9
EF2570 COMPONENT PICTURES	10
EF2870 COMPONENT PICTURES	11
Troubleshooting Guide	12

Always use a qualified technician or service agency to repair this fireplace.

! NOTE: Procedures and techniques that are considered important enough to emphasize.

⚠ CAUTION: Procedures and techniques which, if not carefully followed, will result in damage to the equipment.

⚠ WARNING: Procedures and techniques which, if not carefully followed, will expose the user to the risk of fire, serious injury, or death.

OPERATION

EF2870

Figure 1

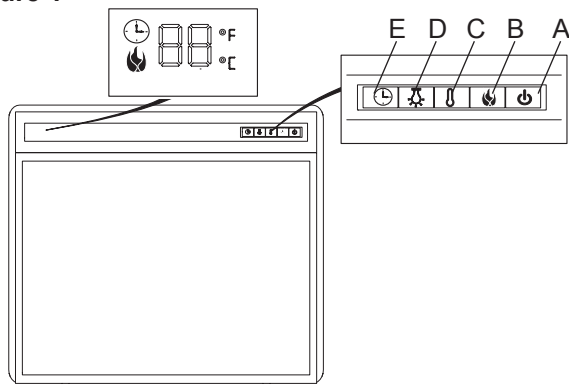

⚠ WARNING: This electric firebox must be properly installed before it is used.

The manual controls for the unit are located in the top right hand corner. (Figure 1)

! NOTE: Press any button to activate the On-Screen display before making any changes.

A - ⏻ Standby

Turns the unit On and Off. When the unit is turned back On, the system will recall its last heat setting used.

! NOTE: When the unit is turned OFF the embers of the log set will not immediately go out. This is a designed feature to represent the embers of the fire slowly fading out

! NOTE: Although the heater has been turned off the fan may still run to prevent over heating.

B - 🔥 Light Control

Adjusts the brightness of the flames and logs. Repeatedly pressing the light control button will cycle through the five different levels of flame brightness.

When adjusting the brightness of the flames this icon will light up with a blue light. The setting will be displayed on the main display with L1 being the lowest setting and L5 being the highest.

! NOTE: When the unit is in L4 the logs will slowly fade On and Off.

C - ⚖ Thermostat

By pressing the ⏻, on the firebox, or the ▲ and ▼, on the remote, the 7 different temperature settings that the firebox can be operated at will be cycled through.

60°C (99°F) → 30°C (86°F) → 28°C (82°F) → 26°C (78°F) → 24°C (75°F) → 22°C (71°F) → "OF" (for use without the heater)

Press and hold the down arrow for 5 seconds to switch temperature readout from °C and °F.

Disable Heat

If desired, depending on the season, the heater on the unit can be disabled. The unit will operate in the same fashion, with remainder of the controls.

To disable:

Press and holding the ⏻ button on the unit for 5 seconds will disable the heater, indicated by the temperature display flashing.

To enable:

With the temperature displayed (it will be flashing), press and hold the ⏻ button on the unit for 5 seconds to reactivate the heating controls.

D - 🔦 Down Lighting On/Off

Turns the down lighting On and Off.

E - ⌚ Sleep Timer

This icon will light up with a blue light when using the Timed Shut-OFF function. A time will be displayed on the main display ranging from 10(minutes) to 6 (hours).

Resetting the Temperature Cutoff Switch

Should the heater overheat, an automatic cut out will turn the heater off and it will not come back on without being reset. It can be reset by unplugging the unit and waiting 5 minutes before plugging the unit back in.

⚠ CAUTION: If you need to continuously reset the heater, unplug the unit and call technical support at 1-888-346-7539.

Remote Control (Figure 2)

The fireplace is supplied with an IR multifunction remote.

Before the remote will operate the plastic insulating sheet needs to be removed.

Battery Replacement

Battery Requirements: CR2025 button battery

- 1 Locate and remove the battery bracket (Figure 2).
- 2 The battery has two sides, one with a button feature, and the other is flat.
- 3 Insert the battery with the button side down into the battery bracket, making sure the battery is firmly seated.

 Battery must be recycled or disposed of properly. Check with your Local Authority or Retailer for recycling advice in your area.

Figure 2



EF2570

Figure 3

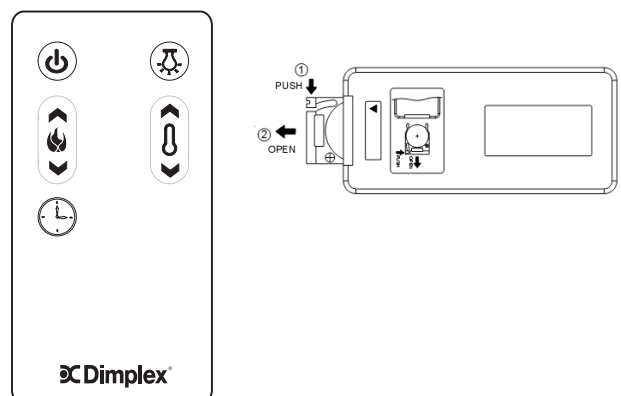
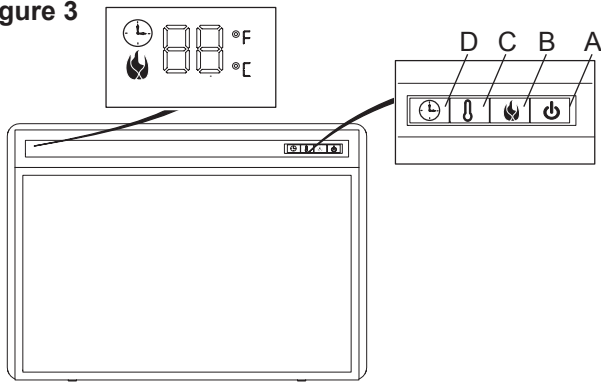

⚠ WARNING: This electric firebox must be properly installed before it is used.

The manual controls for the unit are located in the top right hand corner. (Figure 3)

! NOTE: Press any button to activate the On-Screen display before making any changes.

A - ⏻ Standby

Turns the unit On and Off. When the unit is turned back On, the system will recall its last heat setting used.

! NOTE: When the unit is turned OFF the media lighting will not immediately go out. This is a designed feature to represent the embers of the fire slowly fading out.

! NOTE: Although the heater has been turned off the fan may still run to prevent over heating.

B - 🔥 Light Control

Adjusts the lighting of the media. Repeatedly pressing the light control button will cycle through the five different colors of flame.

When adjusting the color of the media lighting this icon will light up with a blue light. The setting will be displayed on the main display with the flames in the corresponding color: L1 - Blue, L2 - Pink, L3 - White, L4 - Autocycle, and L5 - Orange.

C - 🌡 Thermostat

By pressing the 🌡, on the firebox, or the ⬆ and ⬇, on the remote, the 7 different temperature settings that the firebox can be operated at will be cycled through.

60°C (99°F) → 30°C (86°F) → 28°C (82°F) → 26°C (78°F) → 24°C (75°F) → 22°C (71°F) → "OF" (for use without the heater)

Press and hold the down arrow for 5 seconds to switch temperature readout from °C and °F.

Disable Heat

If desired, depending on the season, the heater on the unit can be disabled. The unit will operate in the same fashion, with remainder of the controls.

To disable:

Press and holding the ⏻ button on the unit for 5 seconds will disable the heater, indicated by the temperature dis-

play flashing.

To enable:

With the temperature displayed (it will be flashing), press and hold the ⏻ button on the unit for 5 seconds to reactivate the heating controls.

D - ⌚ Sleep Timer

This icon will light up with a blue light when using the Timed Shut-OFF function. A time will be displayed on the main display ranging from 10 (minutes) to 6 (hours).

Resetting the Temperature Cutoff Switch

Should the heater overheat, an automatic cut out will turn the heater off and it will not come back on without being reset. It can be reset by unplugging the unit and waiting 5 minutes before plugging the unit back in.

⚠ CAUTION: If you need to continuously reset the heater, unplug the unit and call technical support at 1-888-346-7539.

Remote Control (Figure 4)

The fireplace is supplied with an IR multifunction remote.

Before the remote will operate the plastic insulating sheet needs to be removed.

Battery Replacement

Battery Requirements: CR2025 button battery

- ① Locate and remove the battery bracket (Figure 4).
- ② The battery has two sides, one with a button feature, and the other is flat.
- ③ Insert the battery with the button side down into the battery bracket, making sure the battery is firmly seated.

 Battery must be recycled or disposed of properly. Check with your Local Authority or Retailer for recycling advice in your area.

Figure 4



EXPLODED PARTS DIAGRAM - EF2870

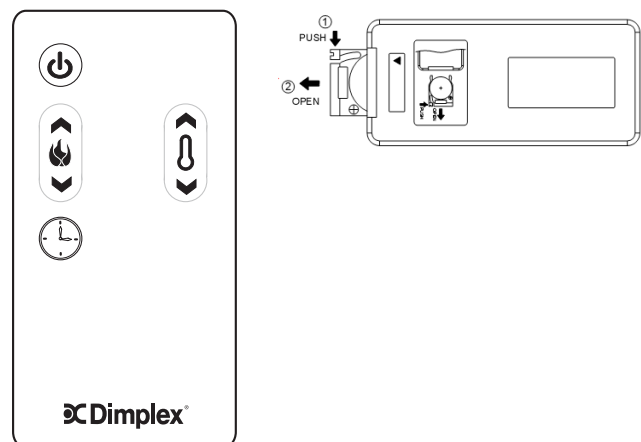
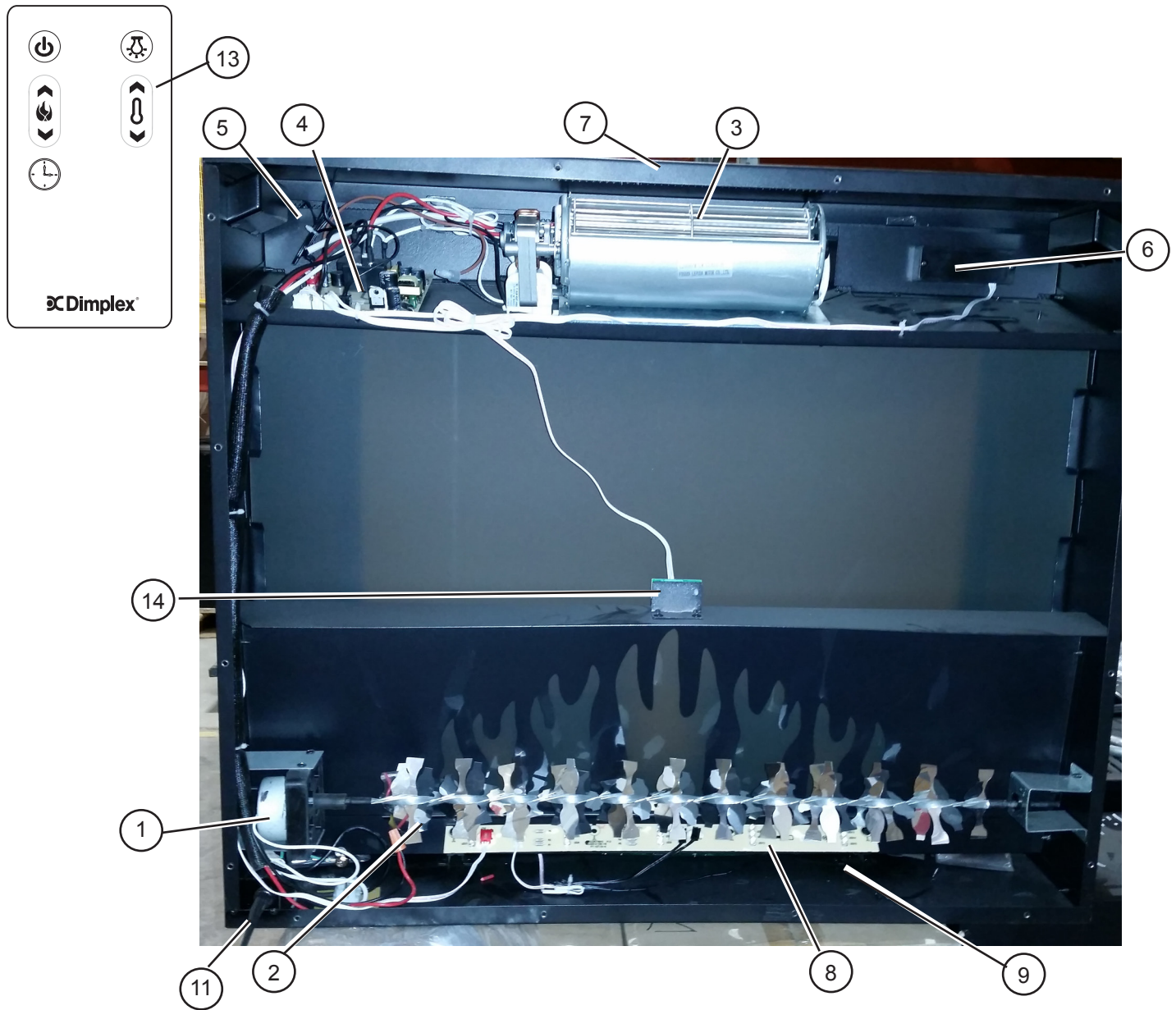

REPLACEMENT PARTS - EF2870

1. Flicker Motor	9601130100RP	9. Ember LED's	9601130900RP
2. Flicker Rod	9601130200RP	10. Down Lights	9601131000RP
3. Heater Assembly (with cutout)	9601130300RP	11. Cord Set	9601131100RP
4. Control Board	9601130400RP	12. Front Glass Assembly	9601131200RP
5. Switchboard	9601130500RP	(comes with screws to attach to unit)	
6. Display Board	9601130600RP	13. Remote Control	9601131300RP
7. Thermistor	9601130700RP	14. IR Sensor	9601131400RP
8. Flame LED's	9601130800RP	15. Logset Assembly	9601131500RP

EXPLODED PARTS DIAGRAM - EF2570

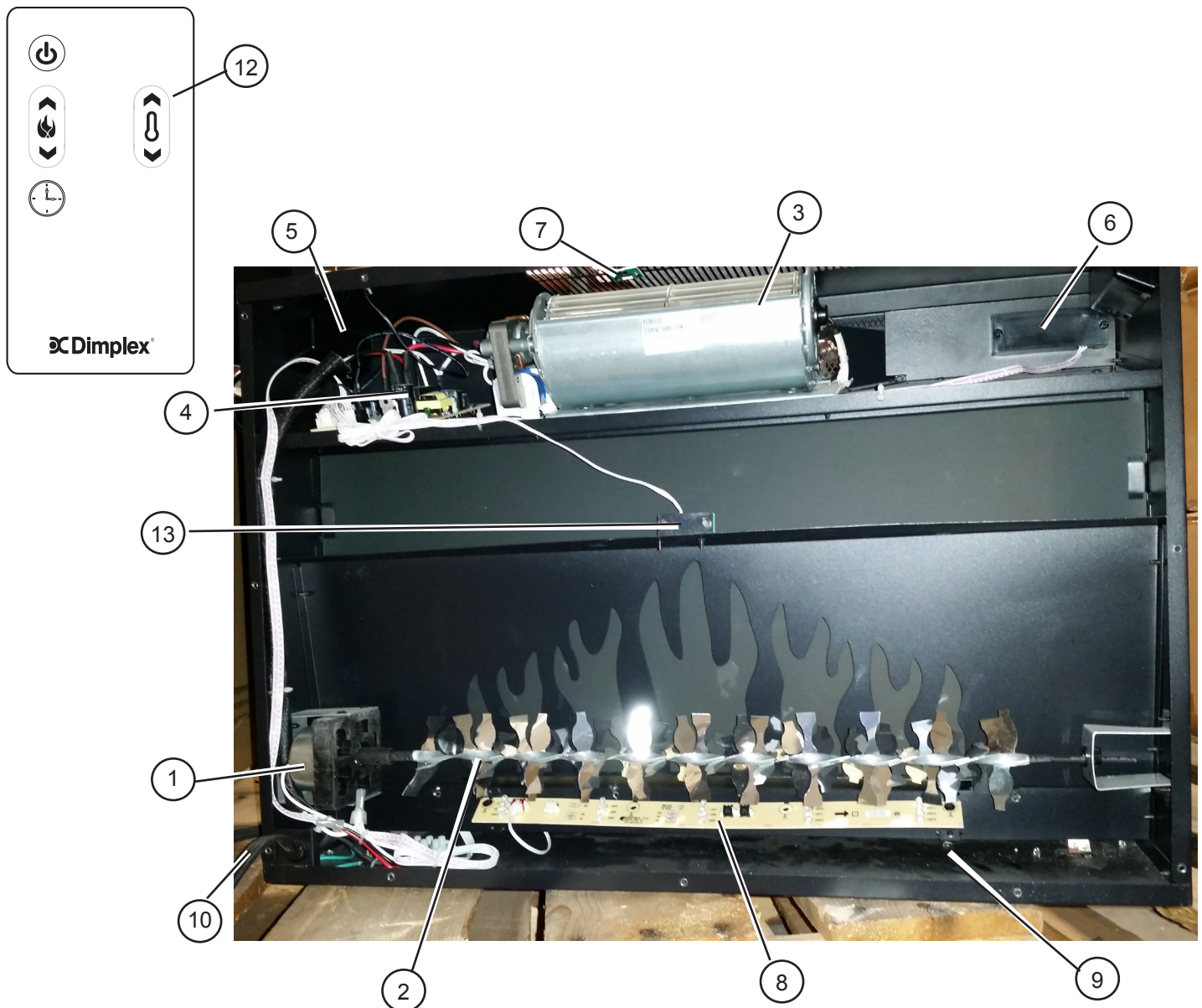

REPLACEMENT PARTS - EF2570

1. Flicker Motor	9601130100RP	10. Cord Set	9601131100RP
2. Flicker Rod	9601140100RP	11. Front Glass	9601140500RP
3. Heater Assembly (with cutout)	9601130300RP	(comes with screws to attach to unit)	
4. Control Board	9601130400RP	12. Remote Control	9601140600RP
5. Switchboard	9601140200RP	13. IR Sensor	9601131400RP
6. Display Board	9601130600RP	14. Crystals	9601140700RP
7. Thermistor	9601130700RP	15. River Stones	9601140800RP
8. Flame LED's	9601140300RP		
9. Ember LED's	9601140400RP		

WIRING DIAGRAM - EF2870

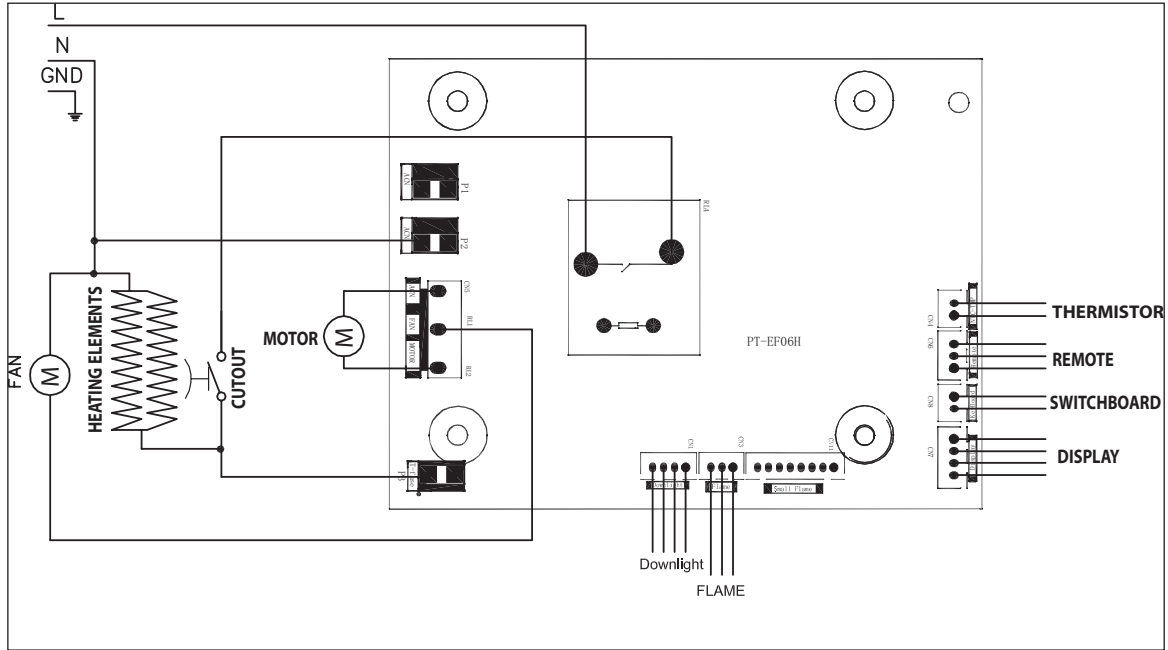

WIRING DIAGRAM - EF2570

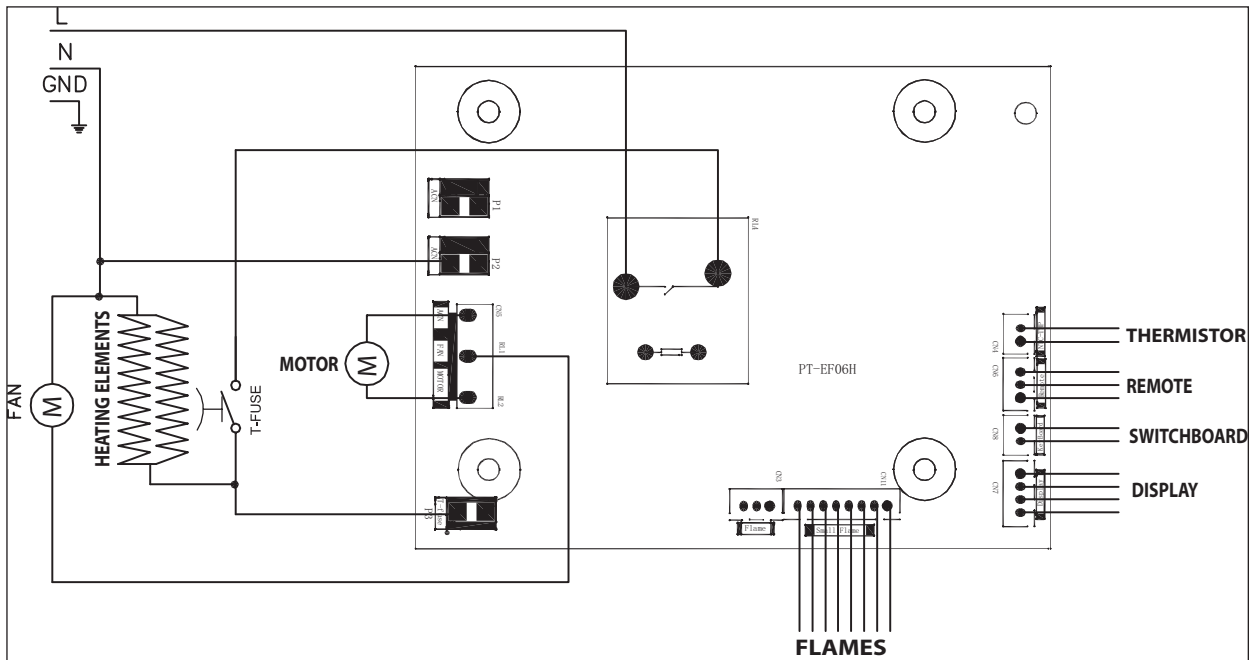

FLICKER MOTOR REPLACEMENT

Tools required: Phillips head screwdriver

⚠ WARNING: If the fireplace was operating prior to servicing allow at least 10 minutes for the heating elements to cool off to avoid accidental burning of skin.

⚠ WARNING: Disconnect circuit power before attempting any maintenance or cleaning to reduce the risk of electric shock or damage to persons.

1. Remove the firebox out of the cabinet.
2. From the back of the unit remove the screws (16 on the EF2870 and 12 on the EF2570) that secure the back panel to the firebox.
3. Locate the flicker rod and gently move it horizontally to the right, to disengage the end from the rubber grommet on the flicker motor.
4. Locate the flicker motor retaining bracket
5. Disconnect the two screws, from the outside of the unit, that secure the mounting bracket to the side, to remove the flicker motor.
6. Remove the flicker motor from the bracket and trace the wires to the wire connectors or terminal block (mounted on the bottom of the unit).
7. Disconnect the wiring connections noting their original locations, from the terminal block, and replace with the wires from the new motor.
8. Reassemble in the reverse order as above.

FLAME LED REPLACEMENT

Tools required: Phillips head screwdriver

⚠ WARNING: If the fireplace was operating prior to servicing allow at least 10 minutes for light bulbs and heating elements to cool off to avoid accidental burning of skin.

⚠ WARNING: Disconnect circuit power before attempting any maintenance or cleaning to reduce the risk of electric shock or damage to persons.

1. Remove the firebox out of the cabinet.
2. From the back of the unit remove the screws (16 on the EF2870 and 12 on the EF2570) that secure the back panel to the firebox.
3. Locate the flicker rod and gently move it horizontally to the right, to disengage the end from the rubber grommet on the flicker motor.
4. Locate the flame LED strip.
5. Remove the 2 retaining screws.
6. Disconnect the wiring connection and install the new LED board.
7. Reassemble in the reverse order as above.

CORD SET REPLACEMENT

Tools required: Phillips head screwdriver

⚠ WARNING: If the fireplace was operating prior to servicing allow at least 10 minutes for the heating elements

to cool off to avoid accidental burning of skin.

⚠ WARNING: Disconnect circuit power before attempting any maintenance or cleaning to reduce the risk of electric shock or damage to persons.

1. Remove the firebox out of the cabinet.
2. From the back of the unit remove the screws (16 on the EF2870 and 12 on the EF2570) that secure the back panel to the firebox.
3. Locate and disconnect the power cord wiring connections, on the terminal block, noting their original locations.
4. With needle nose pliers grasp the power cord strain relief grommet from inside the right rear of the panel and push while twisting to remove.
5. Pull the power cord out through the hole in side of the unit.
6. Insert the new power cord through the hole and connect all of the wiring connections in their original locations.
7. Install the power cord strain relief grommet on the replacement cord.
8. Reassemble in the reverse order as above.

DISPLAY BOARD REPLACEMENT

Tools required: Phillips head screwdriver

⚠ WARNING: If the fireplace was operating prior to servicing allow at least 10 minutes for the heating elements to cool off to avoid accidental burning of skin.

⚠ WARNING: Disconnect circuit power before attempting any maintenance or cleaning to reduce the risk of electric shock or damage to persons.

1. Remove the firebox out of the cabinet.
2. From the back of the unit remove the screws (16 on the EF2870 and 12 on the EF2570) that secure the back panel to the firebox.
3. Locate and remove the display board cover, secured with two screws.
4. Remove the two screws securing the display board to the unit.
5. Trace the wire back to the control board and disconnect.
6. Connect the new control board and reassemble.

⚠ WARNING: Ensure wires do not come in contact with moving parts by securing wires in wiring tie wraps.

IR SENSOR REPLACEMENT

Tools required: Phillips head screwdriver
Needle Nose Pliers

⚠ WARNING: If the fireplace was operating prior to servicing allow at least 10 minutes for the heating elements to cool off to avoid accidental burning of skin.

⚠ WARNING: Disconnect circuit power before attempting any maintenance or cleaning to reduce the risk of

electric shock or damage to persons.

1. Remove the firebox out of the cabinet.
2. From the back of the unit remove the screws (16 on the EF2870 and 12 on the EF2570) that secure the back panel to the firebox.
3. Locate and disconnect the two tabs, by squeezing the tabs securing the IR sensor to the unit, with needle nose pliers.
4. Trace the wire back to the control board and disconnect.
5. Connect the new IR sensor and reassemble.

⚠ WARNING: Ensure wires do not come in contact with moving parts by securing wires in wiring tie wraps.

THERMISTOR REPLACEMENT

Tools required: Phillips head screwdriver

⚠ WARNING: If the fireplace was operating prior to servicing allow at least 10 minutes for the heating elements to cool off to avoid accidental burning of skin.

⚠ WARNING: Disconnect circuit power before attempting any maintenance or cleaning to reduce the risk of electric shock or damage to persons.

1. Remove the firebox out of the cabinet.
2. From the back of the unit remove the screws (16 on the EF2870 and 12 on the EF2570) that secure the back panel to the firebox.
3. Remove the top panel by removing the two screws on either end.
4. Locate and remove the thermistor from the unit, secured by one screw.
5. Trace the wire back to the control board and disconnect.
6. Connect the new thermistor and reassemble.

⚠ WARNING: Ensure wires do not come in contact with moving parts by securing wires in wiring tie wraps.

HEATER ASSEMBLY REPLACEMENT

Tools required: Phillips head screwdriver

⚠ WARNING: If the fireplace was operating prior to servicing allow at least 10 minutes for the heating elements to cool off to avoid accidental burning of skin.

⚠ WARNING: Disconnect circuit power before attempting any maintenance or cleaning to reduce the risk of electric shock or damage to persons.

1. Remove the firebox out of the cabinet.
2. From the back of the unit remove the screws (16 on the EF2870 and 12 on the EF2570) that secure the back panel to the firebox.
3. Remove the top panel by removing the two screws on either end.
4. The heater assembly is attached to the unit with two brackets (one at the front of the unit and the other at the back) with two screws on each. Remove the heater

assembly from the unit.

5. Disconnect the wiring connections, at the control board, and install the new heater assembly.
6. Reattach the wiring and reassemble.

⚠ WARNING: Ensure wires do not come in contact with moving parts by securing wires in wiring tie wraps.

SWITCHBOARD REPLACEMENT

Tools required: Phillips head screwdriver

⚠ WARNING: If the fireplace was operating prior to servicing allow at least 10 minutes for the heating elements to cool off to avoid accidental burning of skin.

⚠ WARNING: Disconnect circuit power before attempting any maintenance or cleaning to reduce the risk of electric shock or damage to persons.

1. Remove the firebox out of the cabinet.
2. From the back of the unit remove the screws (16 on the EF2870 and 12 on the EF2570) that secure the back panel to the firebox.
3. Remove the top panel by removing the two screws on either end.
4. Locate and remove the switch board from the unit, secured by two screws.
5. Disconnect the wiring connection and install the new switchboard.
6. Connect the new switchboard and reassemble.

⚠ WARNING: Ensure wires do not come in contact with moving parts by securing wires in wiring tie wraps.

CONTROL BOARD REPLACEMENT

Tools required: Phillips head screwdriver

⚠ WARNING: If the fireplace was operating prior to servicing allow at least 10 minutes for the heating elements to cool off to avoid accidental burning of skin.

⚠ WARNING: Disconnect circuit power before attempting any maintenance or cleaning to reduce the risk of electric shock or damage to persons.

1. Remove the firebox out of the cabinet.
2. From the back of the unit remove the screws (16 on the EF2870 and 12 on the EF2570) that secure the back panel to the firebox.
3. Remove the top panel by removing the two screws on either end.
4. Locate and remove the control board from the unit, secured by four screws.
5. Disconnect the wiring connection, noting their original locations, and install the new switchboard.
6. Connect the new switchboard and reassemble.

⚠ WARNING: Ensure wires do not come in contact with moving parts by securing wires in wiring tie wraps.

EF2570 COMPONENT PICTURES

Front view of unit



Heater Assembly, Control board & IR Sensor

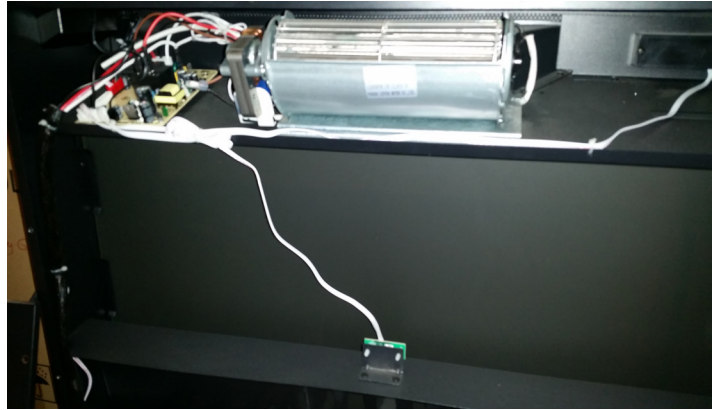

Flicker Motor, Terminal Block, Flicker Rod and Cord Set Connection

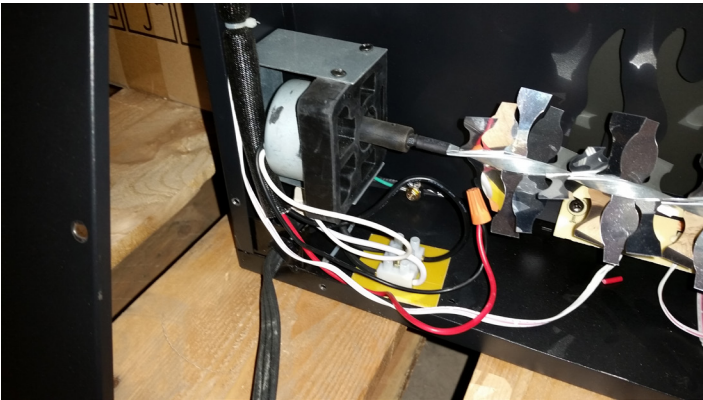

Flame LED Assembly



Display Board (with cover and without)



Control Board



EF2870 COMPONENT PICTURES

Front view of unit



Heater Assembly and Control board



Flicker Motor, Terminal Block and Flicker Rod

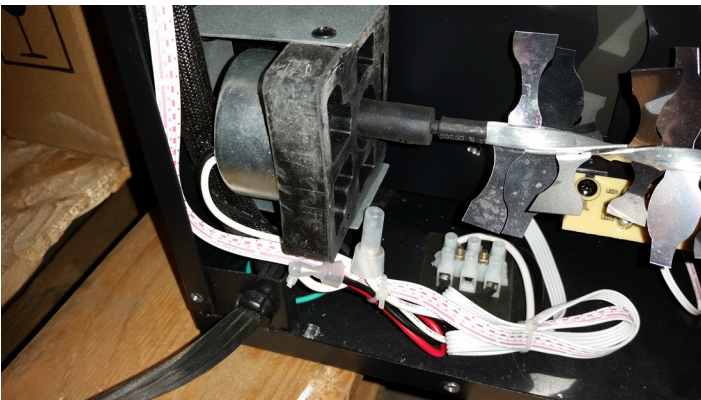

Flame LED Assembly



Display Board (with cover and without)



Control Board and Switch Board



Thermistor

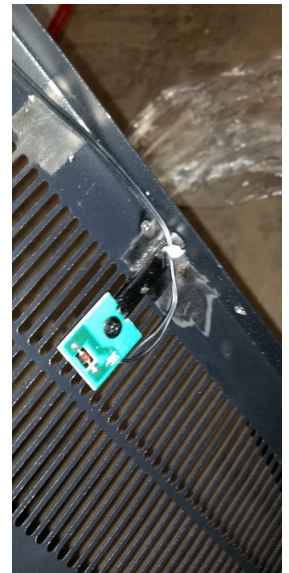

TROUBLESHOOTING GUIDE

PROBLEM	CAUSE	SOLUTION	PART NUMBER
General			
Circuit breaker trips or fuse blows when unit is turned on	Short in unit wiring.	Trace wiring in unit.	
	Improper circuit current rating	Additional appliances may exceed the current rating of the circuit breaker or fuse. Plug unit into another outlet or install unit on a dedicated 15 amp circuit.	
Lights dim in room while the unit is on	Unit is drawing close to circuit current rating	Move the unit to another outlet or install unit on a dedicated 15 amp circuit	
Power cord gets warm	Normal Operation	The power cord may get slightly warm to the touch when the heater is on	
	Defective power cord	Replace power cord if cord gets hot to the touch.	9601131100RP
Appearance			
Fireplace does not turn on with manual controls	Improper operation	Refer to Operation Section	
	No incoming voltage from the electrical wall socket	Check Fuse/Breaker Panel	
	Loose wiring	Check wiring connections	
	Defective switchboard	Replace the switchboard	25" - 9601140200RP 28" - 9601130500RP
	Defective control board	Replace the control board	9601130400RP
Fireplace does not turn on with the Remote Control	Improper operation	Refer to Operation Section	
	The batteries in the remote control are dead.	Install new battery into the remote control.	
	Defective remote control	Replace the remote control	25" - 9601140600RP 28" - 9601131300RP
	Defective IR sensor	Replace IR sensor	9601131400RP
	Defective control board	Replace the control board	9601130400RP
Display is not working	Loose wiring	Check wiring connections	
	Defective display board	Replace the display board	9601130600RP
	Defective control board	Replace the control board	9601130400RP
Display is showing "88"	Unit requires resetting	Turn all of the controls to Off and unplug the unit from the wall for 5-10 minutes, then plug back in	
Display has a "EEE" showing	Loose connection of the thermistor	Check wiring connection	
	Defective thermistor	Replace the thermistor	9601130700RP
Flame Frozen	Loose wiring	Check wiring connections	
	Defective Flicker Motor	Replace Flicker Motor	9601130100RP
Flame is not visible	Loose wiring	Check wiring connections	
	LED flame assembly is not working	Replace LED flame assembly	25" - 9601140300RP 28" - 9601130800RP
	Defective control board	Replace the control board	9601130400RP
Flame Shudder	Defective Flicker Motor	Replace Flicker Motor	9601130100RP
Media is not lighting up	Loose wiring	Check wiring connections	
	Ember LED light assembly is not working	Replace ember LED light assembly	25" - 9601140400RP 28" - 9601130900RP
Light leaking around the log set (if applicable)	Log set not positioned properly	Check log set for proper fit	

PROBLEM	CAUSE	SOLUTION	
Heater			
Heater is not turning off	Improper operation	Refer to Operation Section	
	Defective switchboard	Replace switchboard	25" - 9601140200RP 28" - 9601130500RP
	Defective thermistor	Replace thermistor	9601130700RP
	Defective control board	Replace the control board	9601130400RP
Heater is not turning on, but flame effect is still functioning	Improper operation	Refer to Operation Section	
	Unit requires resetting	Turn all of the controls to Off and unplug the unit from the wall for 5-10 minutes, then plug back in	
	Loose wiring	Trace wiring in unit	
	Defective switchboard	Replace switchboard	25" - 9601140200RP 28" - 9601130500RP
	Defective heater assembly	Replace heater assembly	9601130300RP
	Defective control board	Replace the control board	9601130400RP
Heater is turning off after a couple of minutes of operation	Build up of dirt/dust in Heater Assembly	Ensure that exterior intake louvers and firebox cavity are free of dirt/dust.	
	Defective heater assembly	Replace heater assembly	9601130300RP
Heater emits an odor	Normal Operation	Normal operation is when the heater emits an odor for a brief period after the heater is initially turned on. The heater is burning off any dust accumulated during manufacturing or operation.	
	Defective heater assembly	Replace heater assembly	9601130300RP
Heating element is glowing red	Normal Operation	Small glowing sections of the element are considered normal.	
	Defective heater assembly	If larger glowing sections are causing the heater to trip the thermal cutout, unplug unit, discontinue use and replace heater assembly.	9601130300RP
Noise			
Excessive noise with the heater on	Dirty Heater Assembly	Ensure that exterior intake louvers and firebox cavity are free of dirt/dust.	
	Defective heater assembly	Replace heater assembly	9601130300RP
Grinding or excessive noise with the heater off	Flicker rod hitting or rubbing against internal components	Ensure rod is straight and mounted properly in the bracket, spinning freely away from other components. Replace if necessary.	
	Defective Flicker Motor	Replace Flicker Motor	9601130100RP