



Better solutions through innovation

Owner's Manual

Model

DFI400LH (6909050141)

DFI400RH (6909050142)

DFI600LH (6909050161)

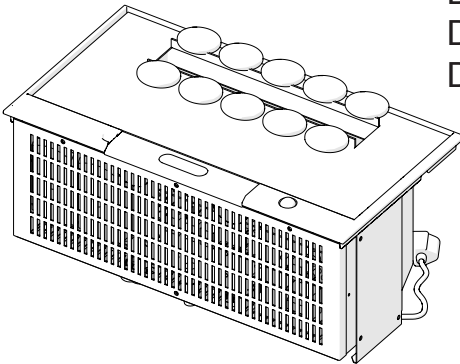









IMPORTANT SAFETY INFORMATION: Always read this manual first before attempting to install or use the Optimyst® cassette. For your safety, always comply with all warnings and safety instructions contained in this manual to prevent personal injury or property damage.

To view the full line of Dimplex products, please visit www.dimplex.com

7212780100R05





Table of Contents

 Welcome & Congratulations	3
 IMPORTANT SAFETY INSTRUCTIONS	4
 Installation	6
 Assembly	9
 Operation	11
 Maintenance	13
 Warranty	15
 Replacement Parts	17

Always use a qualified technician or service agency to repair this cassette.

! NOTE: Procedures and techniques that are considered important enough to emphasize.

 **CAUTION:** Procedures and techniques which, if not carefully followed, will result in damage to the equipment.

 **WARNING:** Procedures and techniques which, if not carefully followed, will expose the user to the risk of fire, serious injury, or death.

Welcome & Congratulations

Thank you and congratulations for choosing to purchase an Optimyst® cassette from Dimplex, the world leader in electric fireplaces.

Please carefully read and save these instructions.

⚠ CAUTION: Read all instructions and warnings carefully before starting installation. Failure to follow these instructions may result in a possible electric shock, fire hazard and will void the warranty.

Please record your model and serial numbers below for future reference: model and serial numbers can be found on the Model and Serial Number Label of your cassette.

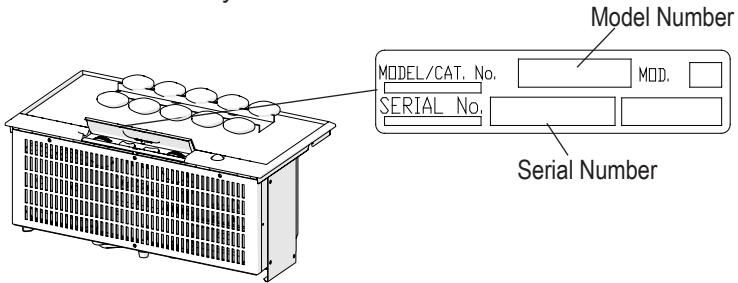

NO NEED TO RETURN TO THE STORE

Questions with operation or assembly? Require Parts Information?
Product Under Manufacturer's Warranty?

Contact us at:  www.dimplex.com/customer_support
For Troubleshooting and Technical Support

OR  **Toll-Free 1-888-DIMPLEX (1-888-346-7539)**
Monday to Friday 8:00 a.m. to 4:30 p.m. EST
Please have your model number and product serial
number ready. (See above)



IMPORTANT SAFETY INSTRUCTIONS

THIS UNIT IS FOR HOUSEHOLD / RESIDENTIAL USE ONLY.

THE ELECTRICAL RATING FOR THESE MODELS IS 120VAC, 60 HZ, 12 AMP.

When using an electrical furnishing, basic precautions should always be followed, including the following:

Read all instructions before using (this furnishing).

⚠ DANGER: To reduce the risk of electric shock always unplug this furnishing from the electrical outlet before cleaning.

⚠ WARNING: To reduce the risk of burns, fire, electric shock, or injury to persons:

- ① Unplug from outlet before putting on or taking off parts.
- ② Close supervision is necessary when this furnishing is used by, or near children, invalids, or disabled persons.
- ③ Use this furnishing only for its intended use as described in these instructions. Do not use attachments not recommended by the manufacturer.
- ④ Never operate this furnishing if it has a damaged cord or plug, if it is not working properly, if it has been

dropped or damaged, or dropped into water. Contact Dimplex Technical Service at 1-888-346-7539 for replacement parts.

⑤ Keep the cord away from heated surfaces.

⑥ Never operate the furnishing with the air openings blocked. Keep the air openings free of lint, hair, and the like.

⑦ Never drop or insert any object into any opening.

⑧ Do not use outdoors.

⑨ Do not operate where aerosol (spray) products are being used or where oxygen is being administered.

⑩ To disconnect, turn all controls to the off position, then remove plug from outlet.

⚠ WARNING: Risk of Electric Shock – Connect this furnishing to a properly grounded outlet only. See Grounding Instructions.

⑪ This electrical appliance has hot and arcing or sparking parts inside. Do not use in areas where gasoline, paint, or flammable liquids are used or stored.

⑫ Do not modify the unit. Use it

IMPORTANT SAFETY INSTRUCTIONS

only as described in this manual. Any other use not recommended by the manufacturer may cause fire, electric shock or injury to persons.

⑬ To reduce the risk of electric shock, this appliance has a three pronged plug. This plug will fit in a grounded outlet only one way. If the plug does not fit, contact a qualified electrician to install the proper outlet. Do not change the plug in any way. Always plug this appliance directly into a wall outlet/receptacle. Never use with an extension cord or relocatable power tap (outlet/power strip).

⑭ Keep away from curtains, draperies and similar materials.

⑮ Always use a certified electrician should new circuits or outlets be required.

⑯ Always use properly grounded, fused and polarized outlets.

⑰ When transporting or storing the unit and cord, keep in a dry place, free from excessive vibration and store so as to avoid damage.

⑱ This furnishing has not been evaluated for flammability or cigarette ignition resistance.

⑲ Do not submerge.

⑳ Light bulb requirement: 45W, 12VAC halogen bulbs type MR 16. Contact Dimplex Technical Service at 1-888-346-7539 for replacement bulbs.

㉑ The electric fireplace shall be installed in an enclosure no smaller than that indicated. (See Figure 2)

 **CAUTION:** The receptacle cord is intended for use only with the Dimplex heater 6909070159, 120VAC, 60Hz., 1000W.

! NOTE: Changes or modifications not expressly approved by the party responsible for compliance could void user's authority to operate the equipment.

 **WARNING:** Remote control contains small batteries. Keep away from children. If swallowed, seek medical attention immediately.

 **WARNING:** Do not install battery backwards, charge, put in fire or mix with used or other battery types - may explode or leak causing injury.

SAVE THESE INSTRUCTIONS

Installation

⚠ WARNING: Ensure the power cord is not installed so that it is pinched or against a sharp edge and ensure that the power cord is stored or secured to avoid tripping or snagging to reduce the risk of fire, electric shock or injury to persons.

Grounding Instructions

This product must be grounded. If it should malfunction or breakdown, grounding provides a path of least resistance for electric current to reduce the risk of electric shock. This product is equipped with a cord having an equipment-grounding conductor and a grounding plug. The plug must be plugged into an appropriate outlet that is properly installed and grounded in accordance with all local codes and ordinances.

⚠ DANGER: Improper connection of the equipment-grounding conductor can result in a risk of electric shock. Check with a qualified electrician or serviceman

if you are in doubt as to whether the product is properly grounded. Do not modify the plug provided with the product – if it will not fit the outlet, have a proper outlet installed by a qualified electrician.

This product is for use on a nominal 120-volt circuit and has a grounding plug that looks like the plug in Figure 1. Make sure that the product is connected to an outlet having the same configuration as the plug. No adapter should be used with this product.

⚠ CAUTION: Risk of Electric Shock. This product has two cords. Unplug both cords before moving or servicing this furnishing.

! NOTE: A 15 Amp, 120 Volt circuit is required. A dedicated circuit is preferred but not essential in all cases. A dedicated circuit will be required if, after installation, the circuit breaker trips or fuse blows on a regular basis when the cassette is operating. Additional appliances on the same circuit may exceed the current rating of the circuit breaker.

Mantel Installation

Install the fireplace into the mantel (refer to mantel assembly instructions).

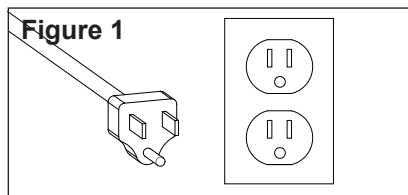

Installation

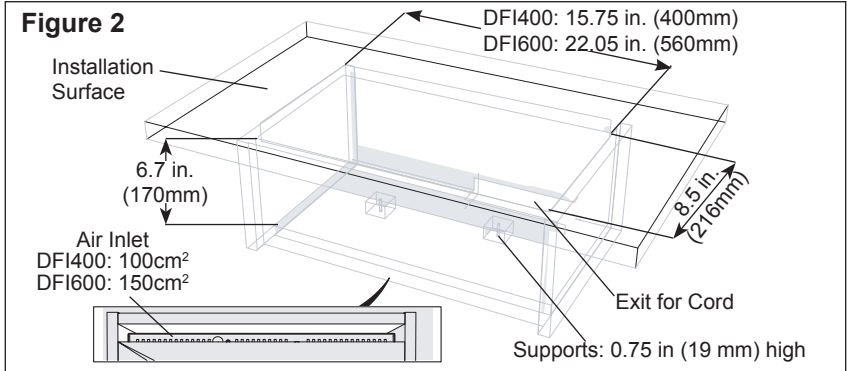

New Construction

1. Mark the desired location on the floor and store the fireplace in a safe, dry and dust free location.
2. Use studs to frame an enclosure with the following **minimum** internal/opening dimensions (Figure 2).

! NOTE: An air inlet is required for optimum mist production, see Figure 2 for **minimum** dimensions.

! NOTE: For optimal performance, the following **minimum** clearances between the installation surface and any surface above should be maintained:

- Cassette Only: 12 in. (305 mm)
- Cassette with Dimplex heater: 19 in. (483 mm)

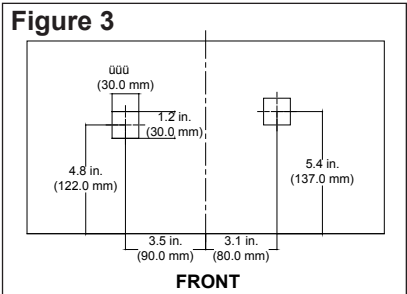

3. Secure unit through the two holes in the bottom of the unit into supports to prevent the unit from hanging from the top flange, see figure 3 for dimensions.
4. The unit is equipped with a power supply plug and a fused receptacle (Figure 4), the plug should be plugged directly into a 15 A, 120 V outlet.

⚠ CAUTION: During operation

Installation

ensure that the receptacle cord is positioned so that the face is perpendicular to the floor as in Figure 4.

⚠ CAUTION: For continued protection against risk of fire, replace only with same type and rating of fuse, 10 amp fuse maximum.

5. The receptacle is intended for plugging in a Dimplex heater (supplied with the mantel), which will allow the heater to be controlled with the provided remote. (Figure 4)

⚠ CAUTION: The receptacle cord is intended for use only with the Dimplex heater 6909070159. If this receptacle is used with any other product, Dimplex will not be liable for any damage or issues that may arise.

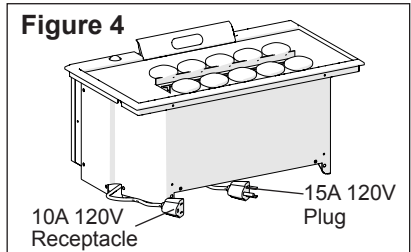

Assembly

1. Carefully unpack all of the components from the box. (Figure 5)
2. Remove top cover by turning the retaining tabs on both ends of the water reservoir. (Figure 6)
3. Install the light bulbs by

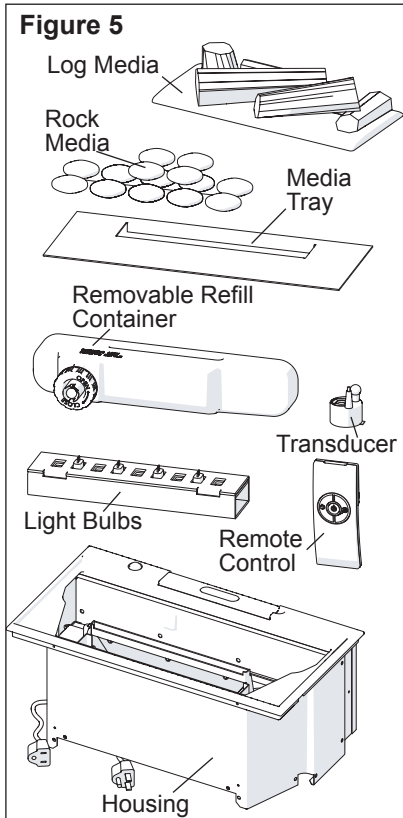

4. Install the transducer so that it is sitting level in the circular holding area in the reservoir. (Figure 7)
5. Orient transducer wire so that it does not sit directly above the emitter and the wire passes through the slot in the side of the tank. (Figure 6)
6. Reinstall the top cover and ensure both retaining tabs have been turned so that they are pointing inwards.
7. Fill and install the Refill Container.

! NOTE: Normal tap water can be used in the Optimyst® as long as the tap water is not considered to be hard water. In the event your tap water is hard, you may use softened water or distilled water with 1/8 tsp of salt (0.5 mL) added to the water reservoir. (The addition of additional salt should only be used when you notice that the unit is not producing mist as expected.)

! NOTE: During initial installation, the Refill Container should be refilled after the Reservoir has filled to ensure the maximum operating time.

Assembly

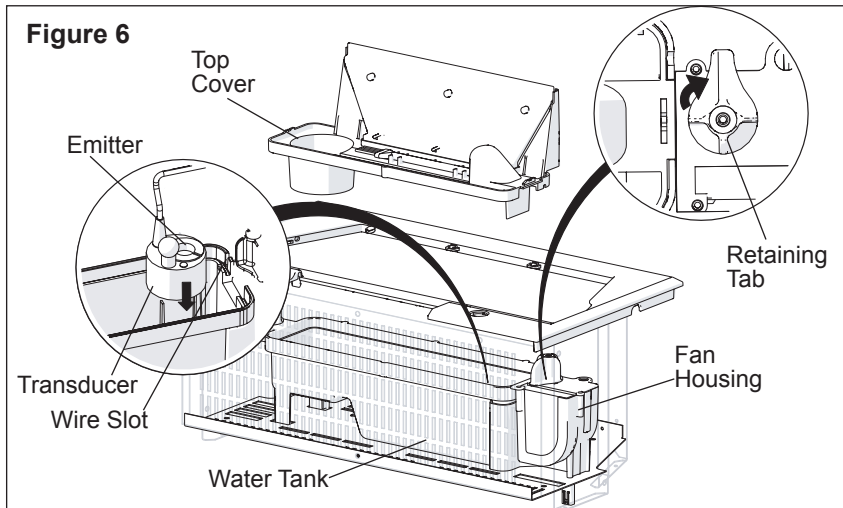

8. Install the media on top, log assembly or rock media and media tray, so that the opening is not blocked (Figure 7).

⚠ CAUTION: Do not arrange the rock media while the unit is running, since the rocks may be hot.

9. Make sure the On/Off switch is switched to Off (refer to Operating Instruction section).
10. Plug the unit into a 15 Amp/ 120 volt outlet.

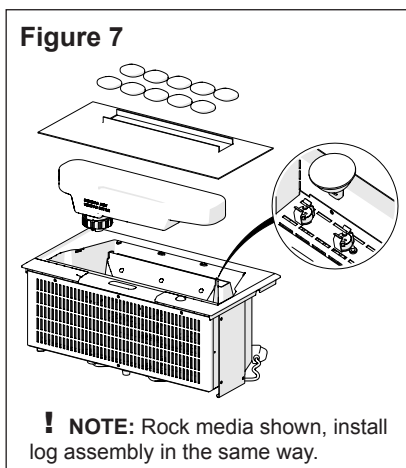

Operation

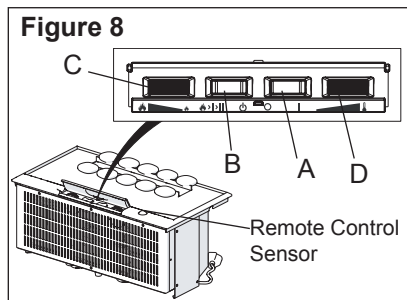

CAUTION: During operation ensure that the receptacle cord is positioned so that the face is perpendicular to the floor as in Figure 4.

NOTE: Always ensure that the appliance is in an upright position before operating the unit.

NOTE: When the cassette is used in an environment where background noise is very low, it may be possible to hear a sound which is related to the operation of the flame effect. This is normal and should not be a cause for concern.

The manual controls for the cassette are located on the top of the unit, below the control cover. (Figure 8)

A. On/Off Switch

Supplies power to the cassette.

B. Mode Selector Switch

Press once to turn on the flame effect. This will be indicated by an audible “beep”. Although the lights

turn on immediately it will take 30 seconds before the flame effect starts.

- Press again to give flame effect and heat*. This will be indicated by two “beeps”.
- Press again to return to flame effect only. This will be indicated by one “beep”.
- Press  to put fire in to stand-by mode. This will be indicated by one “beep”.

C. Flame Intensity Control

Adjusts the intensity of the flame effect when the heater has been activated.

Turning the control knob clockwise to decrease the intensity of the flame effect. Turning the control knob counter-clockwise will increase the flame effect.

NOTE: Give the flame generator some time to react to changes you may make on the flame control knob.

NOTE: When the water tank is empty the unit will turn off after 30 seconds. See instructions under Maintenance Section for refilling tank. When this procedure is complete, the main lamps will illuminate but it will take 30 seconds before the flames return.

D. Thermostat Control*

To adjust the temperature to your

👉 Operation



individual requirements, turn the thermostat control clockwise all the way to turn on the heater. When the room reaches the desired temperature, turn the thermostat knob counter-clockwise until you hear a click. Leave thermostat in this position to maintain the room temperature at this setting. For additional heat, turn clockwise until you hear the click again and the heater will turn on.

* Only applicable when the Dimplex heater has been plugged into the receptacle.

Remote Control

The On/Off Switch must be in the 'ON' (I) position in order for the remote control to operate. There are 3 buttons on the remote control. (Figure 9)

! NOTE: To operate correctly, the remote control must be pointed towards the remote control sensor. The remote control functions are as follows:

-  Press once to turn on Flame effect only. This will be indicated by one beep.
-  Press once to turn on heat and Flame effect. This will be indicated by two beeps.
-  Standby - This will be indicated by one beep.

! NOTE: Once the mist has been activated, the unit will have to be turned Off, using either the switches on the unit, or the standby button on the remote control, then back on to return to flame effect operation only.

Battery Replacement

To replace the battery:

1. Slide battery cover open on the remote control (Figure 9).
2. Install two 1.5 Volt (AAA) batteries in the battery holder.
3. Close the battery cover.

 Battery must be recycled or disposed of properly. Check with your Local Authority or Retailer for recycling advice in your area.

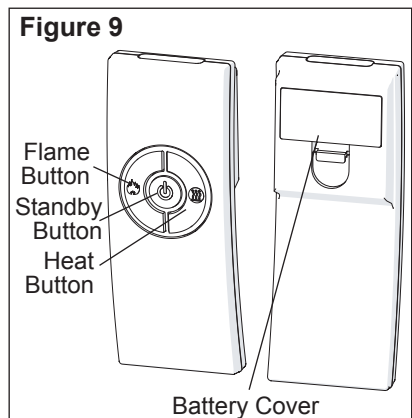



Maintenance

⚠ WARNING: Disconnect power before attempting any maintenance or cleaning to reduce the risk of fire, electric shock or damage to persons.

Filling the water tank

When the water tank is empty, the flame shuts off and you will hear 2 audible beeps, follow these steps.

⚠ CAUTION: Allow at least five minutes for components to cool before disassembling the unit to refill.

1. Turn the On/Off switch to the off position (**0**) (Figure 8)
2. Gently remove the media tray and media (if applicable) and place them carefully on the ground.
3. Remove the refill container by lifting upwards and outwards.
4. Refill the container with tap water.

! NOTE: Normal tap water can be used in the Optimyst® as long as the tap water is not considered to be hard water. In the event your tap water is hard, you may use softened water or distilled water with 1/8 tsp of salt (0.5 mL) added to the water reservoir. (The addition of additional salt should only be when you notice that the unit is not producing mist as expected.)

5. Screw the cap back on, **do not overtighten**.
6. Return the refill container to the water tank.
7. Gently place the media tray and media (if applicable) back into position.
8. Turn the On/Off switch to the off position (**I**). (Figure 8)

If you do not intend on using the unit for longer than 2 weeks, empty and drain the unit of water, and dry all of the water containing components.

Replacing the Light bulbs

If a large amount of the flame appears grey or colourless it may be that one or more of the light bulbs have burnt out.

⚠ CAUTION: Allow at least 5 minutes for light bulbs to cool before touching bulbs to avoid accidental burning of skin.

Light bulb requirement: 45W, 12VAC halogen bulbs type MR 16. Contact Dimplex Technical Service at 1-888-346-7539 for replacement bulbs.

1. Leaving the flame effect on, remove the media (if applicable), tray and water tank (Figure 6) and lift out the top cover.
2. View the lamps from a distance



Maintenance

in front of the fire and observe which lamp needs to be changed.

3. Turn the unit off, and unplug the cassette.
4. Leave the appliance for 5 minutes to allow the lamps to cool down before removing them.
5. Remove the water tank and top cover (Figure 6) by lifting upwards and place in a sink.
6. Remove the defective bulb, by gently lifting vertically and disengaging the pins from the lamp holder.
7. Carefully insert the two pins of the new bulb into the two holes in the lamp holder. Push lamp firmly in place.
8. Gently place the media tray and media (if applicable) back into position.

Cleaning

It is recommended that all of the components that contain water are cleaned with soap and water on a **biweekly** basis. A small brush has been included to assist in cleaning difficult items/areas, i.e. the transducer.

⚠ CAUTION: Do not put plastic components in the dishwasher.

Filter Cleaning

The air filter can be removed and gently rinsed with water to clean and dried on a towel before re-installing.

! NOTE: Replace the filter so that the coarse black filter is facing the front of the cassette.

Surface Cleaning

Use a warm damp cloth only to clean surfaces of the cassette. Do not use abrasive cleaners.

! NOTE: If you need to move the unit ensure that all of the components that contain water have been emptied before relocating.

Servicing

Except for installation and cleaning described in this manual, an authorized service representative should perform any other servicing.



Warranty

ONE YEAR LIMITED WARRANTY

Products to which this limited warranty applies

This limited warranty applies to your newly purchased Dimplex cassette and to newly purchased Dimplex fireplace surrounds (mantels) and trims. This limited warranty applies only to purchases made in any province of Canada except for Yukon Territory, Nunavut, or Northwest Territories or in any of the 50 States of the USA (and the District of Columbia) except for Hawaii and Alaska. This limited warranty applies to the original purchaser of the product only and is not transferable.

Products excluded from this limited warranty

Products purchased in Yukon Territory, Nunavut, Northwest Territories, Hawaii, or Alaska are not covered by this limited warranty. Products purchased in these States, provinces, or territories are sold AS IS without warranty or condition of any kind (including, without limitation, any implied warranties or conditions of merchantability or fitness for a particular purpose) and the entire risk of as to the quality and performance of the products is with the purchaser, and in the event of a defect the purchaser assumes the entire cost of all necessary servicing or repair.

What this limited warranty covers and for how long

Products covered by this limited warranty have been tested and inspected prior to shipment and, subject to the provisions of this warranty, Dimplex warrants such products to be free from defects in material and workmanship for a period of 12 months from the date of the first purchase

of such product.

The limited 12 month warranty period also applies to any implied warranties that may exist under applicable law. Some jurisdictions do not allow limitations on how long an implied warranty lasts, so the above limitation may not apply to the purchaser.

What this limited warranty does not cover

This limited warranty does not apply to products that have been repaired (except by Dimplex or its authorized service representatives) or otherwise altered. This limited warranty does further not apply to defects resulting from misuse, abuse, accident, neglect, incorrect installation, improper maintenance or handling, or operation with an incorrect power source.

What you must do to get service under this limited warranty

Defects must be brought to the attention of Dimplex Technical Service by contacting Dimplex at 1-888-DIMPLEX (1-888-346-7539), or 1367 Industrial Road, Cambridge Ontario, Canada N1R 7G8. Please have proof of purchase, catalogue/model and serial numbers available when calling. Limited warranty service requires a proof of purchase of the product.

What Dimplex will do in the event of a defect

In the event a product or part covered by this limited warranty is proven to be defective in material or workmanship during the 12 month limited warranty period you have the following rights:

- Dimplex will in its sole discretion either repair or replace such defective product or part without charge. If Dimplex is unable to repair or replace



Warranty

such product or part, or if repair or replacement is not commercially practicable or cannot be timely made, Dimplex may, in lieu of repair or replacement, choose to refund the purchase price for such product or part.

- Limited warranty service will be performed solely by dealers or service agents of Dimplex authorized to provide limited warranty services.
- The purchaser is responsible for removal and transportation of such product or part (and any repaired or replacement product or part) to and from the authorized dealer's or service agent's place of business.
- This limited warranty does not entitle the purchaser to on-site or in-home services. On-site or in-home services may be performed at the purchaser's specific request and expense at Dimplex's then-current rates for such services.
- Dimplex will not be responsible for, and the limited warranty services shall not include, any expense incurred for installation or removal of the product or part (or any replacement product or part) or any labour or transportation costs. Such costs shall be the purchaser's responsibility.

What Dimplex and its dealers and service agents are also not responsible for:

IN NO EVENT WILL DIMPLEX, OR ITS DIRECTORS, OFFICERS, OR AGENTS, BE LIABLE TO THE PURCHASER OR ANY THIRD PARTY, WHETHER IN CONTRACT, IN TORT, OR ON ANY OTHER BASIS, FOR ANY INDIRECT, SPECIAL,

PUNITIVE, EXEMPLARY, CONSEQUENTIAL, OR INCIDENTAL LOSS, COST, OR DAMAGE ARISING OUT OF OR IN CONNECTION WITH THE SALE, MAINTENANCE, USE, OR INABILITY TO USE THE PRODUCT, EVEN IF DIMPLEX OR ITS DIRECTORS, OFFICERS, OR AGENTS HAVE BEEN ADVISED OF THE POSSIBILITY OF SUCH LOSSES, COSTS OR DAMAGES, OR IF SUCH LOSSES, COSTS, OR DAMAGES ARE FORESEEABLE. IN NO EVENT WILL DIMPLEX, OR ITS OFFICERS, DIRECTORS, OR AGENTS BE LIABLE FOR ANY DIRECT LOSSES, COSTS, OR DAMAGES THAT EXCEED THE PURCHASE PRICE OF THE PRODUCT.

SOME JURISDICTIONS DO NOT ALLOW THE EXCLUSION OR LIMITATION OF INCIDENTAL OR CONSEQUENTIAL DAMAGES, SO THE ABOVE LIMITATION OR EXCLUSION MAY NOT APPLY TO THE PURCHASER.

How State and Provincial law apply

This limited warranty gives you specific legal rights, and you may also have other rights which vary from jurisdiction to jurisdiction. The provisions of the United Nations Convention on Contracts for the Sale of Goods shall not apply to this limited warranty or the sale of products covered by this limited warranty.



Replacement Parts

Remote Control	9600385600RP
Remote Control Receiver	9600580100RP
Rock Media (DFI400RH)	9600650100RP
Media Tray (DFI400RH)	9600710100RP
Log Set Assembly - DFI400LH	9600720100RP
- DFI600LH	9600730100RP
Light Holder Assembly	9600610200RP
Removable Refill Container with Cap	0441440100RP
Cap for Refill Container	0441440300RP
Top Cover Assembly	9600670100RP
Water Tank	0441380100RP
Fan Assembly	5300300100RP
Fan Housing Assembly	9600540100RP
Fan Filter	8600300100RP
Transducer	3800040100RP
Power Cord	9600740100RP
Receptacle Cord	9600780100RP
On/Off Switch	9600383500RP
3-Position Switch	9600383600RP
Transformers	9600690100RP
Potentiometer	9600640100RP
Thermostat Assembly	9600620100RP
Control Knob	9600630200RP
Power Board	9600590100RP
IR Receiver with Lens	9600600200RP
Light Bulbs	RB400
Fuse Holder	9600790100RP
Fuse	9600790200RP



Dimplex North America Limited

1367 Industrial Road

Cambridge ON

Canada N1R 7G8

© 2013 Dimplex North America Limited